

RADIO AMATEUR NEWS

REG. U.S. PAT. OFF.

20 Cents
MAY
1920

Over 100 Illustrations
Edited by H. GERNSBACK

HER MASTER'S
VOICE



"THE 100% WIRELESS MAGAZINE"

RADIO AMATEUR NEWS



CONTENTS

FOR MAY

PAGE	Page
Undeveloped Radio By H. Gernsback, Editor 607	Ideas—Fifth Spasm By Thomas W. Benson 621
French Application of the Momentous Vacuum Tube.....By Capitaine Metz 608	The Radio Constructor..... 622
Priess Loop Set, Method of Operation By Walter J. Henry 610	A Close Core Magnetic Rectifier By J. Stanley Brown 624
Found Via Radio.....By Lester Archer 611	Combined Audio and Radio Frequency Amplification.....By Palmer H. Craig 625
Dancing by Radiophone..... 612	Announcement of New Radio Prize Con- test 627
Navy Radio Again..... 613	Radio Digest 628
New Radio Apparatus..... 614	Club Gossip 629
New Foreign Radio Apparatus..... 615	With the Amateurs 630
The Kaehni Prize Station..... 620	Pioneer Days in Radio Telephony. By Austin C. Lescarbourea 632
Construction of a Mounting for Home- made Honeycomb Coils By Winton G. George 626	Junior Section 634
Radiophone Contest Prize Winners..... 616	Junior Constructor 636
Variometers.....By S. M. Edwards 619	I-Want-To-Know 638
Fading Signals.....By Clyde J. Fitch 621	

RADIO AMATEUR NEWS is published on the 25th of each month at 233 Fulton Street, New York. There are 12 numbers per year. Subscription price is \$2.00 a year in U. S. and possessions; Canada and foreign countries, \$2.50 a year. U. S. coin as well as U. S. stamps accepted (no foreign coins or stamps). Single copies, 15 cents each. A sample copy will be sent gratis on request. Checks and money orders should be drawn to order of EXPERIMENTER PUBLISHING CO., INC. If you should change your address notify us promptly, in order that copies be not mis-carried or lost. No copies sent after expiration.

All communications and contributions to this journal should be addressed to: Editor, RADIO AMATEUR NEWS, 233 Fulton Street, New York. Unaccepted contributions cannot be returned unless full postage has been

included. ALL accepted contributions are paid for on publication. A special rate is paid for novel experiments; good photographs accompanying them are highly desirable.

RADIO AMATEUR NEWS. Monthly. Entered as second-class matter June 6th, 1919, at the Post Office at New York, N. Y., under the Act of March 3, 1879. Title registered U. S. Patent Office. Copyright, 1920, by E. P. Co., Inc., New York. The Experimenter Publishing Co., 233 Fulton Street, N. Y., N. Y. The Contents of this magazine are copyrighted and must not be reproduced without giving full credit to the publication.

RADIO AMATEUR NEWS is for sale at all newsstands in the United States and Canada; also at Brentano's, 37 Avenue de l'Opera, Paris. For Great Britain: Geoffrey Parker & Gregg, 62 & 8A, The Mall, Ealing, London.

Published by EXPERIMENTER PUBLISHING CO., INC.
H. GERNSBACK, President

S. GERNSBACK, Treasurer

233 Fulton Street, New York City
R. W. DE MOTT, Secretary



MAGNAVOX

RADIO TELEMEGAFONE

When used with one or more stages of amplification will reproduce signals with great volume. For the small fraction of a watt output of your receiver that is available for the production of signals, the MAGNAVOX TELEMEGAFONE will produce the greatest volume of sound

With Small Horn, as Illustrated \$75.00
With Large Music Master Horn 93.00

WRITE FOR BULLETIN No. 21020

CONNECT "AA" to your detector or amplifier, and "BB" to a 6-volt battery



THE MAGNAVOX Co.

PATENTED IN U.S.A. AND FOREIGN COUNTRIES

2701-2765 EAST 14TH STREET
OAKLAND, CALIFORNIA

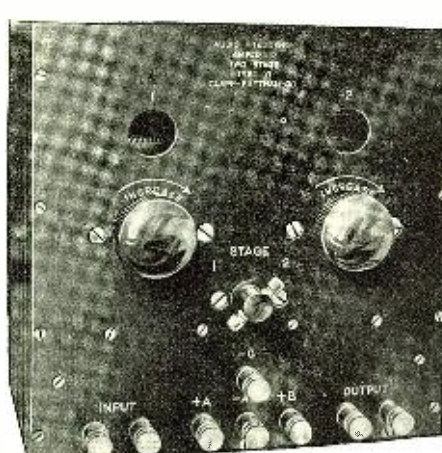

AMPLIFICATION

Somewhat

BEYOND THE USUAL

is

Secured with our type Q. O. coil, designed on a somewhat different principle. Its somewhat higher price is trifling, results considered.

Two Stage Amplifier, complete.....	\$50.00
Type Q. O. Coil, mounted.....	\$7.50
Type Q. O. Coil, unmounted.....	\$5.00

Immediate deliveries—From most good dealers. Bulletins F and Z sent for 4-cent stamps list our complete line of high grade, moderately priced, apparatus for the Radio Laboratory.

THE CAMBRIDGE RECTIFIER

illustrated here will charge your storage batteries at home from any alternating current lamp socket cheaply and simply. It is fully described in Bulletin R.

CLAPP-EASTHAM CO.

120 MAIN STREET CAMBRIDGE, MASS.

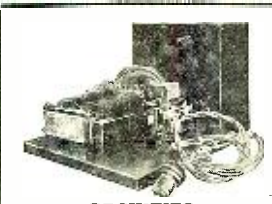

RECTIFIER

NAME
ADDRESS

STATE
ELECTRO IMPORTING COMPANY,
231A Fulton St., New York City.

I enclose herewith 6 cents in stamps or coin for which please send me your latest Cyclopedia Catalog No. 22 containing 80 pages, 200 illustrations and diagrams, including Treatise on Wireless Telegraphy, and 20 coupons for your 160 page Free Wireless Course in 20 lessons.

R.A.N. 5-20

FILL IN THIS COUPON FOR YOUR COPY OF

Our New 80 Page Cyclopedia No. 22 IT IS WAITING FOR YOU

Full size fac-simile of our catalog just as it looks when you get it
1-4 INCH THICK WEIGHT ALMOST 1-2 POUND
200 Illustrations

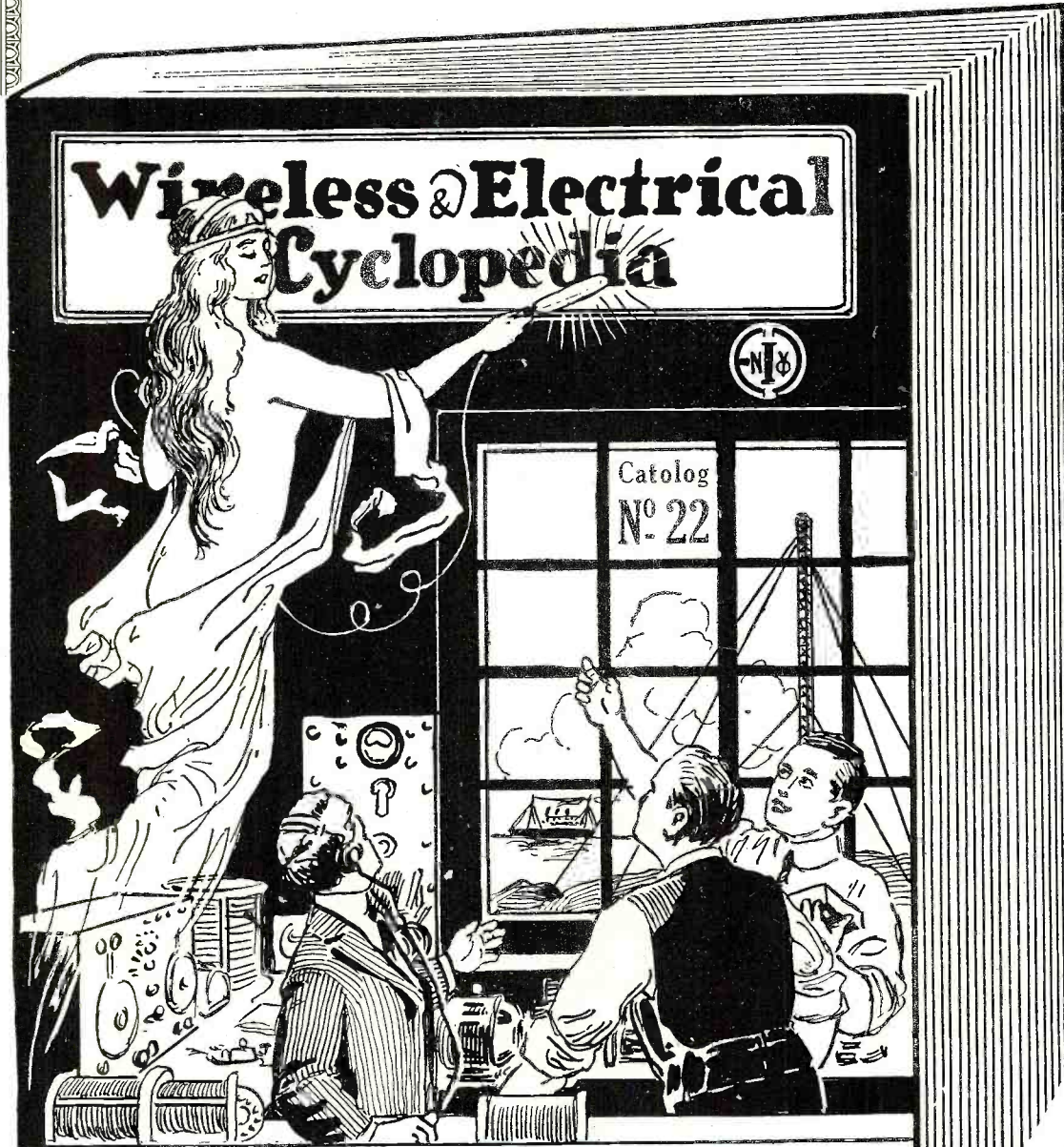

The Electro Importing Co.
231 FULTON STREET NEW YORK
"EVERYTHING FOR THE EXPERIMENTER"

A Few Interesting Things from Catalog No. 22

Treatise on Wireless Telegraphy by H. Gensback, Editor Electrical Experimenter and Radio Amateur News—11 big pages, 3 illustrations.

The Wireless Law of 1912—all about it, what you can do and what you can't.

How to receive and send Radio messages.

How far you can send messages.

Table of wave lengths, of principal U. S. & foreign Radio high power stations.

How to receive time signals by Radio.

How to construct an amateur aerial.

How to use the test buzzer.

How to join the "Radio League of America" FREE, including application blank.

Experiments with a pony telephone receiver, with 6 illustrations.

Experiments with spark coils.

All about storage batteries, how to test them, recharging, etc.

Tesla experiments, 2 pages.

FREE with this wonderful cyclopedia—20 coupons for our 160 page Wireless Course in 20 lessons. 350 illustrations, 30 tables. Catalog explains how you can get this Course absolutely free.

"THE LIVEST CATALOG IN AMERICA"

IN this cyclopedia you will find all about radio. One of the greatest catalogs of its kind in print.

You will find in it dozens of wireless instruments of the famous E. I. Co. make. Remember always that this company was the **FIRST** to make and sell wireless instruments, the first wireless outfit having been placed upon the market by them in 1904. The E. I. Co. *knows how*, because it has the experience.

Others imitate but cannot equal E. I. Co. for quality and workmanship.

Other things you will find listed in this catalog: Electrolytic Interrupters, Bulldog Spark Coils, Chemical Outfits, Code Practice Sets, Primary Batteries, Storage Batteries, Hydrometers, Volt and Ammeters, Batterymeters, Electrolytic Rectifiers, Rheostats, Tesla Coils, Microphones, Loud Talkers, Electro-magnets,

X-ray tubes, Telephones, Mognetos, Low Tension Transformers, Books, etc., etc. **IN A WORD THE MOST COMPLETE CATALOG IN PRINT**

ELECTRO IMPORTING CO.
231A FULTON STREET NEW YORK, N. Y.

"Everything for the Experimenter"

Experimenters!!

FOR RESULTS USE

TRIODE

(Trade Mark)

VACUUM TUBES

\$7.00 Each Postpaid

Immediate Delivery

TRIODE Apparatus also includes vacuum tube sockets, audio frequency simplifying transformers, two step amplifiers, Eaton Oscillators and Grid Leaks. When ordering radio apparatus specify Triode so as to insure receiving only apparatus and appliances supplied by the Wireless Specialty Apparatus Company.

Our Catalog will be sent upon receipt of 25c in stamps.

Wireless Specialty Apparatus Company

Engineers, Designers, Manufacturers

Boston, U. S. A.

THE PERFECT VACUUM TUBE COMBINATION

PRESENTING TWO *NEW* TYPES OF VACUUM TUBES FOR EXPERIMENTERS

—the De Forest 20 Audion Detector and the Moorhead VT Amplifier-Oscillator: perfected to meet the increasing demand for tubes of superior efficiency, wherein all desirable characteristics are combined without subordinating any essential elements.

THE DE FOREST 20 AUDION DETECTOR

Type 20 combines all the advantages of the tubular type De Forest audion, in its extreme sensitiveness as a detector, with those of the Navy standard base. This tube is of the so-called "soft" type, requiring relatively low B battery potential, and is unexcelled as a detector.

Both types of tubes are of unusually rugged construction.

THE MOORHEAD VT AMPLIFIER-OSCILLATOR

The VT Amplifier-Oscillator is similar to the Navy "hard" tube, and is designed and manufactured expressly for amplification and oscillation purposes.

A combination of two or more Moorhead tubes as amplifiers with a De Forest tube as the initial detector or oscillator is the ideal receiving combination for long distance amateur or long wave reception.

These Tubes are Licensed under the De Forest Audion and Fleming Patents.

PRICE \$7 EACH

Specify full names of tubes when ordering. Orders may be placed through a dealer or sent direct, with check, draft, or money order, to the Laboratories. Immediate delivery.

Dealers—write for prices and particulars.

PACIFIC RADIO SUPPLIES CO., SAN FRANCISCO
SOLE SALES AGENTS FOR MOORHEAD LABORATORIES, Inc.

REFERENCES, THE AMERICAN NATIONAL BANK, SAN FRANCISCO.



RADIO AMATEUR NEWS

H. GERNSBACK — EDITOR

Vol. 1.

MAY, 1920

No. 11

Undeveloped Radio

YOU will note that the present issue of RADIO AMATEUR NEWS does not contain the usual page of "Latest Radio Patents." This is not a matter of negligence or oversight on the part of the editors, but is the result of very amazing and very unusual circumstances.

The answer is quite simple. *There have been no radio patents of late.* 90% of the few that we have been printing can really be called inventions. They were simply patents, and that is all. As everyone knows, it is a comparatively simple thing to get a patent on most anything, as long as you have a good patent attorney and are able to incorporate a few new knick-knacks in your device. But such a thing as a really new idea, not to speak of a *basic one*, is scarcer than the proverbial "hen's teeth."

Now, as a matter of fact, radio, by no means, is or has been asleep during the last year. There *has* been development, but this was mainly in the designing and reshaping of old ideas or old stunts well-known heretofore. In other words, what we have been doing is revamping the material that we had on hand. Where we used to have independent instruments, we have now put them into handy boxes and cases, but we have not added much that is new to the art. What we have been doing mostly was changing our styles, which reminds us of the phonograph people.

Here also no radical changes have been wrought during the last five or six years, but manufacturers have busied themselves in redesigning and bettering their output, adding several new styles to their lines. Ten years ago, every phonograph could be taken and placed on the table. They were simply small affairs that sold for ten or fifteen dollars. Today that sort of phonograph is not in demand because the manufacturers have shown us that what we really want is the big cabinet type of phonograph, which is sold all the way up to a thousand dollars each. But nothing radically new has been accomplished.

A similar condition exists in the radio field today. We have been bettering our outfits and apparatus, and we have worked out many new stunts with our vacuum tubes and vacuum tube circuits; mostly the latter as a matter of fact. Every other patent that one comes across is a new circuit concerning a vacuum tube. Of course, this is all well and good, and we would be the last to discourage it. But the great and outstanding fact remains that nothing vitally new has really been brought out lately.

Most of our radio inventors seem to have thrown themselves body and soul on vacuum tube circuits, and seem to have forgotten the rest of the radio art entirely. The writer remembers the time when you could not pick up a copy of the "Patent Gazette" and not run across at least ten to fifteen radio patents a week. Now it is comparatively seldom that you see even one a week, and this one

usually concerns a simple improvement over something else that is well-known, and consequently not worth publicity.

Why this condition should exist is indeed puzzling. An art so young and so vigorous as radio certainly should bring forth more ideas, because so many new things and improvements are wanted. First in line, of course, is the radio telephone which is capable of great improvement. When we mention radio telephony today, one naturally thinks first of the vacuum tube as a transmitter for undamped waves. We have pointed out before, however, that there are many other ways for making an efficient radio telephone. There is a tremendous market existing for a small outfit that can be placed into a suit-case and which works on six dry cells,—an outfit that could transmit over five or six miles or thereabouts. Why does not someone invent it?

Then there are our good old telephone receivers. Year after year, we have been using them, whereas it has often been pointed out that we really do not want them because they tire our heads and ears, and are unsightly and very inefficient. We had an article in our July, 1919, issue about the Radio Translator showing that head receivers are not at all necessary for radio reception.

Then if we do insist upon wearing something about the ear, why not use the De Lange thermophone, which is only about one-half inch long and fits in the opening of the ear, and is as sensitive or more sensitive than the electro-magnetic phone? But why a telephone at all?

Once upon a time, when radio was young and wild, Dr. Pickard conceived the idea of receiving signals by means of a telephone receiver. That idea has stuck to us, and we do not seem to be able to rid ourselves of it. Why must we receive by ear? Why not, for instance, by sight? It can be done and at least as efficiently as by ear. It is simply a matter of education. Even now you will make the remark that an operator "reads" his signals, but, of course, he does not do any such thing. He *hears* them where he should *read* them.

Then about detecting signals. Most of our experimenters have come to the conclusion that the audion type is the ultimate in sensitiveness, but is this actually the case? It does not seem reasonable at all that something could not be invented sooner or later that would put the vacuum tube in the shade. Of course, this is pretty hard to admit today, but unquestionably such an innovation will come about sooner or later. What that new development, that new basic invention will be, no one can guess. It probably will surprise us when it does come.

What our radio inventors should do these days is to reach out for new, basically new things. Get off the beaten path. It is the new and revolutionary thoughts that move the world's progress.

H. GERNSBACK.

French Applications of the Momentous Vacuum Tube

By CAPITAINE METZ*

Translated From the French by Pierre H. Boucheron.

Ed. Note: We consider ourselves fortunate indeed to be able to present our readers with some interesting facts as well as exceptional photographs of specially constructed apparatus incorporating the most talked of subject in radio telegraphy of the present day.

THIS article will describe in two installments the many uses to which the French have placed the vacuum tube; and particularly bearing on the following subjects. Radio as used in the French Army; the use of vacuum tubes permitting the duplication of stations within comparatively small areas; radio telephony; high frequency amplifiers, as well as telemechanics, which is a form of mechanical reception dispensing with the familiar head telephones; the permanent recording of radio messages; the part which the vacuum tube plays in the use of measuring instruments; the multi-vibrator; the suppression of parasite noises; radio apparatus employing very short wavelengths.

We will class the various subjects in three categories, namely,—receiving stations proper, amplifiers, apparatus for instruction and research work.

VARIOUS USES OF COMPLETE UNITS.

It may be said at the start that innumerable sets were constructed, each one designed for a particular use and need. Some of the first were solely transmitters. This is particularly the case of a type specially made for some army divisions and of which we will speak in a later paragraph. Then models were built which were for reception purposes only, and which later found their place as the receiving units of aeroplanes. Units were also constructed which were either transmitters or straight receivers, and these were furnished to the infantry, as well as to some flying machines. In these instances it was possible for aviators to communicate with their aerodromes; detached sections of infantry were enabled to remain in liaison with their companies, and thus many additional uses were made which proved of utmost value during very trying moments of the recent war. We will show later how these sets greatly differed and how much better they proved over the old damp wave or spark method.

THREE GENERAL TYPES OF AMPLIFIERS.

In this instance, also, there are innumerable models, everyone of which is adapted to a particular purpose. We will therefore confine ourselves to the

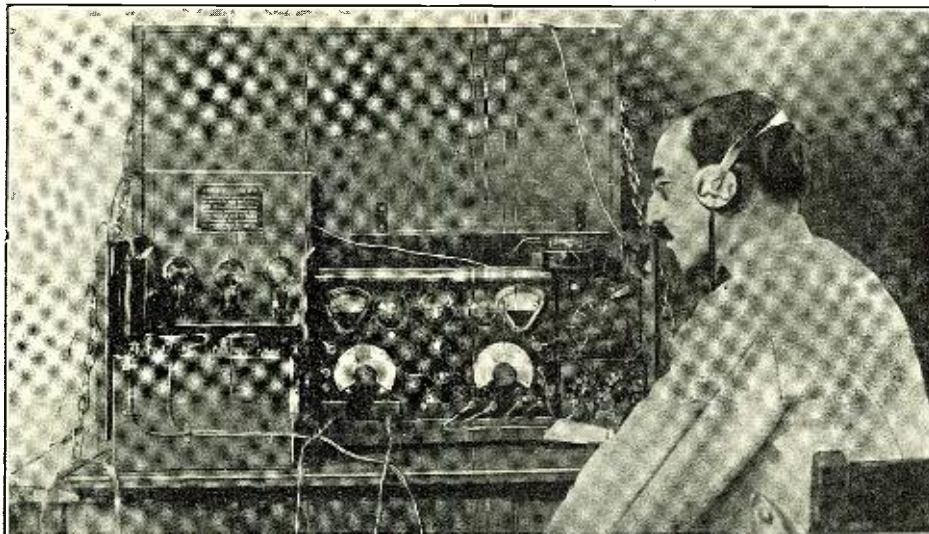

Fig. 1. This Photograph Shows a French Signal Corps Radiographer Operating One of the Army Corps Type Sets. To the Left is the Amplifier-Receiver Instruments; In the Center is the Vacuum Tube Transmitter; While to the Right Are the Various Regulating Devices.

three most common types; that is, low frequency amplifiers, especially the ones employed in the T.P.S. system (ground telegraphy); then we have the *very low frequency amplifiers* or the T.B.F. (this is the French abbreviation) which makes possible so-called "telemechanics." After this come the very high frequency amplifiers which have given such marvelous results in radio compass work as well as in ordinary reception.

APPARATUS FOR INSTRUCTION WORK.

At present the vacuum tube proves itself remarkably well adapted to a multiplicity of uses in the laboratory. We will briefly mention the apparatus which serves for research and measurements. These follow:

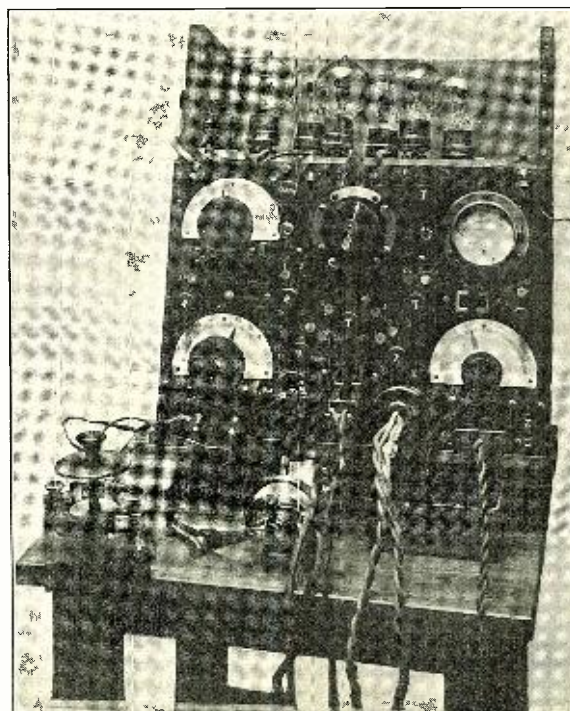

Fig. 4. In This Case We Have a Complete Transmitter-Receiver Field Set Suitable for Small Wavelengths from 250 to 650 Meters.

(a) The multi-vibrator, conceived by M. Abraham, making possible the exact measurement of long wavelengths.

(b) The indispensable heterodyne method for the reception of undamp waves which incidentally also furnishes a means of producing a local source of continuous oscillations at any wavelength.

(c) Experimental sets for very small wavelengths, conceived by M. Gutton, which will permit the remaking, with undamp waves, of the historical experiments of Hertz on the propagation of Hertzian waves

as well as the phenomena which concern luminous waves; in other words, reflection, refraction, etc.

VACUUM TUBE SETS PROPER.

Under this caption, the wonderful work of the vacuum tube is given attention as applied to three subjects, namely: Radio telegraphy; Its uses at the Front; and in general, the great service it has rendered to France and her Allies.

Whether they are simply transmitters such as those used at the beginning of the War or whether combined transmitters and receivers, the various vacuum tube sets considerably outshine the older spark sets and present many advantages possible only with undamp wave propagation. The first and most important great advantage of course is the *extreme selectivity* secured. When an undamp wave set emits waves of 1,000 meters in length, the distant receiver when tuned to 1,000 meters does not respond to a 980 meter wave as was formerly the case in spark work, thereby causing serious interference on other waves. In the present instance it is even possible to install a great number of sets and operate them simultaneously in the same district or sector without interfering with each other either during transmission or reception.

The second advantage, which is also an important one, is that for the same weight and the same distance covered, undamp wave units of the kind mentioned here are operated on approximately *ten times less energy than a spark set*. It is at once evident that the immediate result of this is of tremendous importance, particularly during war time. Another factor is that vacuum tube sets are *much more portable* than others corresponding to the same amount of power.

A third advantage, tho a less important one than would seem, is that the undamp wave set is suitable for radio telephony as well as telegraphy without having to modify its construction in any way. Radio telephony, of which we will speak at greater length later on, has not reached the same

* Etablissement Central de la Radiologie Militaire de France.

state of practicability as radio telegraphy for several reasons, which we will explain in the second section of this article.

Light in weight, robust, easy to set in operation, permitting extensive communications with very little interference, decidedly portable, the vacuum tube unit our enemies did not possess was decidedly an advantage in field work.

A set which was used most extensively during the War is the one which we have named the "Army Corps Type." Incidentally it was the last one to be manufactured in large numbers and a model of the type may be seen in the photograph of Fig. 1. The make-up of this unit includes an oscillator of two or three bulbs. The heterodyne which serves for reception is embodied in the transmitter itself, where a single lamp is used in the receiving position, without antenna and ground as shown in Fig. 2. To this vacuum tube oscillating system is joined an ordinary receiver with a telephone, and an audio frequency amplifier identical to the one used in the T.P.S., or ground system, where the first tube may serve as a detector, if it is not desired to employ galena. These sets may be used with three kinds of antennae represented in Fig. 3. Type C.A. as it is known among French radio men is extremely remarkable in that relatively great results are accomplished at the cost of an almost negligible amount of energy. The tubes consume a filament current of about 12 watts, while on the plate circuit is consumed 60 milliamperes at 350 volts, in other words, 20 watts. With 30 watts total power consumption distances of 250 kilometers have been covered employing an umbrella antenna supported by a No. 27 millimeter mast. If one compares a 630 watt set with a 500 watt spark set, which, even when received by an amplifying system, is far from realizing 250 kilometers; we see here one striking example of the great advantage secured by undamped wave transmission. If it is added that with a set furnishing such excellent results, it is at the same time very durable and sturdy, one will understand the great success that the C. A. type enjoyed with the various armies. The set proper in its container weighs 50 kilograms, and it operates with four storage batteries weighing a total of 160 kilograms. The antenna is composed of several sticks of bamboo and a small amount of wire, while the ground is confined to five metal grids of small diameter, all of which constitute a negligible radiating system, as far as bulk is concerned. To be able to cover 250 kilometers with a set which does not consume 50 watts and does not weigh 250 kilograms complete, is one of the acrobatic feats which vacuum tubes have made possible.

This unit was furnished to the armies at the beginning of 1917 and began to take

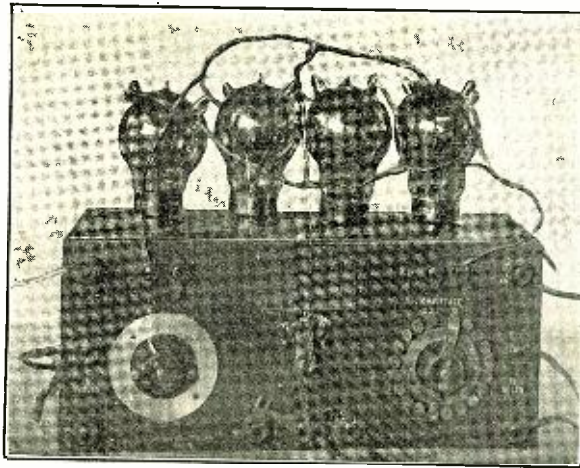

Fig. 5. This is a Set Which is Used Solely for Transmitting Purposes. Note the Projections on Each Tube From Which Connection is Made to the Internal Elements.

part in some of the greatest services of inter-communication between army corps at a time when the Germans were making their famous Noyon retreat, which somewhat surprised us and forced us on long and rapid hikes leaving little time to organize numerous and efficient telephone lines so necessary under such conditions.

The fact which rendered this set of immediate value, was that as an emitter of undamped waves its oscillations were not intercepted by innumerable antennae which the artillery and aviation posts had set up and thus did not interfere in any way with them. The possibility of multiplying

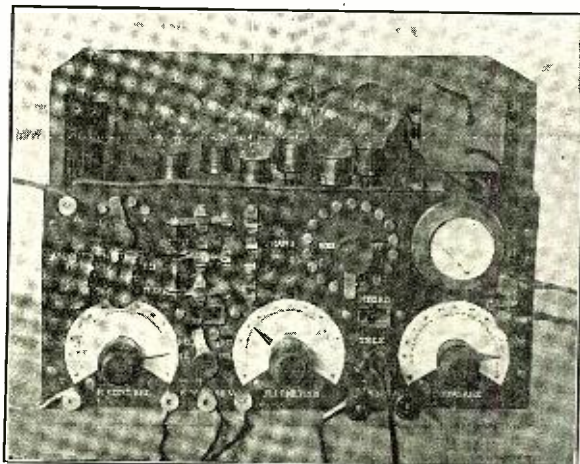

Fig. 6. Transmitter-Receiver Set of Six Vacuum Tubes. This Model Has Effectively Been Employed by Division Posts, Tank Units, Heavy Artillery Sections, as Well as Aviation Units.

transmitters almost without limit, thanks to their great selectivity was therefore, immediately put to good advantage. The wavelengths of two adjacent stations do not have to differ more than 2% in order to avoid all possible interference; in other words, between the wavelengths of 1000 and 1400 meters, the intervening 400 meters permitted the use of 15 individual waves; which could be employed simultaneously without interference! On the other hand, with spark sets only three or four waves at the maximum can be employed under the same conditions, and then with a much smaller degree of security.

These army corps types were always installed on portable standards and were transported about in small auto trucks, on touring cars, in house cars with comfortable quarters, and under these conditions rendered service of the first order. It was also possible to transmit on improvised antennae, which owing to the characteristically feeble potentials of undamped waves, did not necessitate good insulation.

In the rear, the signals were received on ordinary antennae and it was possible to cover several kilometers with a security as great as the T.P.S. system, and of course with much better distances. Fig. 4 shows the field set of the transmitter-receiver type for use on the small waves of 250 to 650 meters.

Under such excellent operating characteristics many radio signal units were established in each army, such as in aeronautic sections, anti-aircraft sections, radio compass sections, etc. The signal sections in the rear, of course, multiplied themselves accordingly. Shortly after this there appeared highly successful signal units between the various armies and general headquarters, as well as between the general headquarters of the allied armies. Then came the aerial division in which radio signal sections united all esquadrones of combat as well as of bombardment, and who in turn were in liaison with the general headquarters of their army.

Of course, other transmitter types were made at the same period as the type C.A. One of these is shown in the photograph of Fig. 5.

The strictly receiver types specially constructed for reception on board aeroplanes, forms an altogether new transition between the regular transmitter sets and the sets designed for the two purposes, which were constructed afterwards. The receiving sets consist in general of three vacuum tubes, where the first lamp is a detector and the other two lamps are amplifiers of low frequencies. On the very late model the fourth lamp was included which precedes the detector lamp and amplifies the received current at high frequency before it has reached the detector.

The transmitter and receiver type of the most recent models comprise, in general, six tubes; three for transmission and three for reception. The last two are mounted like those of the receiver types, while the three transmitter tubes are mounted in parallel. We invite attention to a set which served for a number of purposes.

Another transmitter type consisting of six tubes replaced, near the end of the War, the old C.A. type and was used for the liaisons of rear sections. Fig. 4 shows a short wave unit which can be used for an interior or headquarters work. Finally, in Fig. 6, we have a group of the various types of bulbs employed by the military service.

In the second and final part of this paper will be described French Radio telephone units and the difficulties encountered in their uses: amplifier sets of high, low and very low frequencies, the latter being one of the first practical steps toward telemecanics; Abraham's multi-vibrator, as well as the suppression of "howling" or parasite noises.

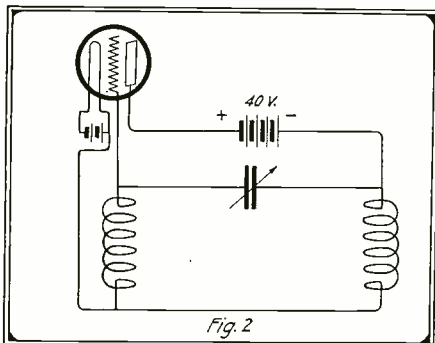

Schematic Diagram of Army Corps Heterodyne Circuit.

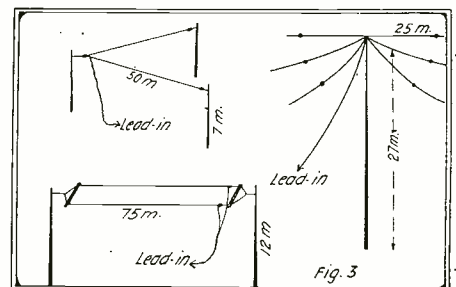

This Shows Three General Types of Antennae Used by the French Signal Corps.

The Pries Loop Set Method of Operation

By WALTER J. HENRY*

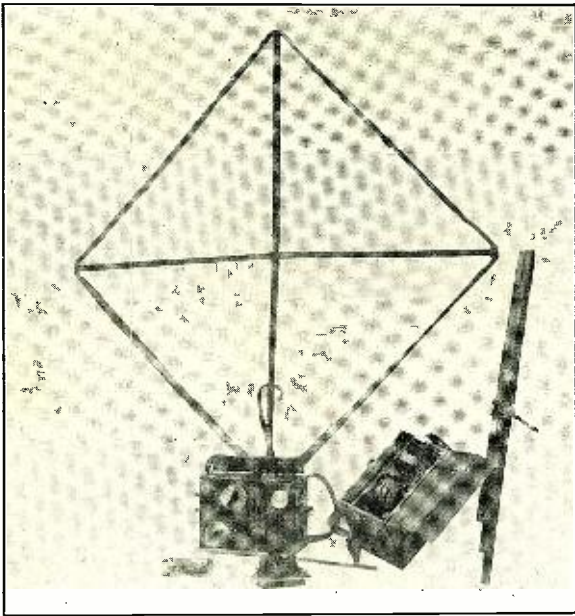

This is a Photograph of The Pries Loop Set Which Proved of Considerable Advantage Under Warfare Conditions. The Loop As Shown Is of a Collapsible Make-up So That It May Be Neatly Folded and Packed in One of the Compartments in the box Shown.

THE proof of the radio set is in the operating. Now that we have thoroughly described the reasons and conditions that caused the development of the Pries Loop Set, and the actual design and construction of the equipment itself, let us see how the set operates under actual field warfare conditions.

It is of prime importance that all communication equipment be capable of working in an army network, that is to say, the system must be so co-ordinated that perfectly interlocking communication free from interference is obtained under all conditions.

This is illustrated by the diagram showing an element of an army in the field. A division consists of two infantry brigades and an artillery brigade. Each infantry brigade is composed of two regiments of three battalions each. Each battalion consists of four companies. The bulk of the troops are of course in the companies. The positions, battalion, regiment and brigade are merely locations for the various tactical control staffs, the battalion post being commanded by a major, the regiment by a colonel, and the brigade by a brigadier-general. The division is of course commanded by a major-general.

The need for constant and reliable communication between the various companies, battalions and regiments is of course fundamental and vital. For example, it is important that a battalion be in communication with its four companies and at the same time its regiment.

The network diagram shows a brigade having two regiments A and B. Each regiment consists in turn, of three battalions numbered 1, 2, and 3. Continuing, each battalion consists of four companies 1, 2, 3, and 4. Now each company, battalion and regiment has a loop set. At first thought one wonders how interference can possibly be avoided with so many sets working in so small an area. With the same number of amateur stations crowded into the same area there would certainly be a wonderful time! Amateur organization is developing, however, and in this

method of radio operation in the army the amateur may well find some valuable suggestions which can be worked out to the general satisfaction of all.

It will be remembered that it was pointed out in the first article of this series that the loop set was provided with three wavelengths, namely, 110, 123, and 140 meters. This system of wavelengths plus the very directional effect of the loop is the secret of non-interference on the battlefield. Specifically this works out as follows: Battalion 1 and all its companies operate on the short wavelength, Battalion 2 and its companies work on the medium wavelength, while Battalion 3 and its companies work, of course, on the long wavelength. This means that the adjacent battalions and companies of a contacting regiment operate on the maximum difference of wavelength.

In actual operation all sets are normally on the receiving position. Location

set is that in cases of attack the battalion is located very close to the company, and communication officially routed thru the battalion forward or rearward is heard at both ends without passing thru the battalion, so that preparation may be made to execute an order before the order has actually arrived.

The extremely sensitive directional effect in transmission and reception of sets in close proximity makes it possible to operate adjacent sets without any interference. The property of directional reception over any distance possess by this apparatus permits location by any two stations of any "lost" outfit equip with this set.

In order to check the satisfactory network operation of the Pries Loop Set it was tested before the General Staff of the U. S. Army in the United States and met with their approval for this type of work for warfare similar to the World War.

WAKE UP, AMERICA!

A recent announcement from Washington reports that the Bureau of Foreign and Domestic Commerce has received advices to the effect that manufacturers of German radio apparatus are making all efforts to dominate the wireless situation in South America, and judging from the vim and vigor they are displaying, are making considerable headway.

This evidently indicates that unless American manufacturers of radio apparatus take immediate action to get into this field, the Germans will soon have a monopoly on supplying all manner of equipment in Central and South America. Wake up manufacturers! We address this in particular to the large interests who have the capital and facilities for foreign propaganda. It is true that we are at present suffering with a spell of under-production, but this will not always be the case, therefore, we should look out for the future, as in a few years manufacturing conditions in this country will probably be normal and many will be seeking foreign outlet. Prepare now; "lay your pipes" today!—P. H. B.

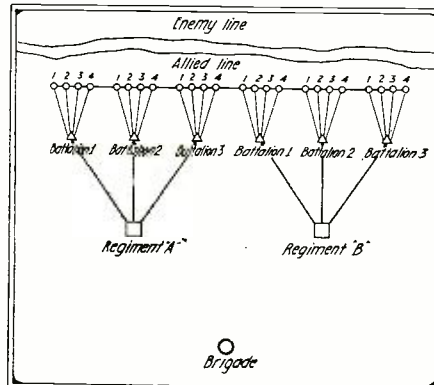

This Diagram Illustrates the Elements of An Army in the Field Where This Remarkable Loop Set Effected Reliable Communication Between Companies, Battalions, and Regiments.

and condition reports are constantly traveling rearward while orders for maneuvers originate in the rear and are promulgated forward. For example, if Company 2 of the 2nd Battalion of Regiment A encounters stiff resistance and wishes a barrage, this would be transmitted back to Battalion 2 on the medium wavelength. Battalion 2 would call Regiment A, and transmit this information with recommendation likewise on the medium wavelength. In this case none of the companies of the other battalions of Regiment A would hear this communication because of the difference in wavelength. The other Companies in Battalion 2 would not hear the communication because of their orientation. The second battalion of adjacent regiments would likewise not hear the communication because of the distance of separation. In the reverse case, if Regiment A wished to communicate with Battalion 2 it would transmit on the medium wavelength, Battalion 2 being normally on the position of receiving medium wavelength would be the only battalion to receive this communication.

The further advantage possess by the



With This Final Installment, We Present a Snapshot of Lieut. W. H. Pries, USA, Whose Energetic Work Made This Efficient Loop Set Possible.

* Sales manager Wireless Specialty Apparatus Co.

Found Via Radio

By Lester Archer



Here Are the Principals Associated With This Dramatic Incident Whereby Amateur Radio Was Responsible For One of the Most Talked-of Incidents of the Last Few Months. The Center Picture is That of Mr. Archer's Sister, Miss Cleo Archer; to the Left May Be Seen Mr. Archer Seated at His Receiving Instruments While to the Right Shows a Close Up of the Complete Receiving Set Upon Which the Author Received the Welcome Signals Disclosing Cleo's Whereabouts.

EDITOR'S NOTE.—*Mr. Archer has written this true account of his experiences specially for R. A. N. We consider this young man and his mother fortunate indeed, and we bow humbly to the Art of Radio for this latest accomplishment.*

AFTER a separation of thirteen years I accomplished in a short time and with the aid of my radio set what my mother and I had been trying to do for thirteen years. I found my sister, Cleo. We had previously used all the means at our disposal to find the sister who had been stolen from us and placed in the Allen County Children's Home when she was five years old.

To find Cleo became the life aim of my mother, Mrs. Dorothy Archer, and myself, and we visited other cities and towns in a vain search, conducting a legal battle all this time trying to compel the home authorities to divulge Cleo's whereabouts.

In our travels I became interested in radio and in 1909, when I was eight years old, set up a receiving set consisting of a potato and two needles.

With this I could hear faint signals from amateurs within a short radius and natural curiosity prompted me to try and learn what the others were saying.

From this it was a quick step to using an old telephone transmitter with batteries as part of the set. I thought it was "great stuff" at that time to be able to get messages, listening in on all the "ham amateurs within a two-mile radius." Those were the days when it was considered quite an achievement for an amateur to construct a set which could receive from a distance of 100 miles.

My next step was to make a Galena Detector with single slide tuning coil, being then able to copy amateurs up to 25 miles. The romance of wireless began to unfold itself at this period for I began learning the code in earnest. Previously I had been content with mastering a few of the important calls.

The next addition to my outfit was an E. I. Co. loose coupler. This meant another step in my climb as a wireless amateur, for I was now able to copy the time signals from the Government station at Arlington.

I also began listening to calls from other large stations. Shortly afterward, when about 12 years old, mother and I again began moving about the country in search for Cleo, visiting a number of large cities.

For the next four years I spent my time experimenting with the audion detector, one of my achievements along that line being an unusual type of hookup which enabled me to receive undamped waves. Nauen, Eilverse, Stavanger, Norway; Lyons and the Eiffel Tower began divulging a few of their secrets to me.

After I had worked out my ideas in this receiving hookup, I began work on a sending set. Since then I have developed my sending set until I can send efficiently over a 1,000-mile radius, recently receiving word from a ship off Cape Lookout that its operators had heard my spark while the ship was in port at Wilmington, S. C., and later while the ship was in the Atlantic. I sent and received messages for three years, developing a large acquaintance, via the ether, with other amateurs all over the lake region. One of my radio friends was Mrs. Charles Candler, of St. Marys, Ohio, who with her husband, is well known to wireless users all over the United States.

I was telling Mrs. Candler of my sister, one evening as we were "haming back and forth" and asked whether it would not be a good stunt to start a search for my sister with the aid of the multitude of amateurs within our reach.

Mrs. Candler offered to relay a message and description of Cleo, as her station is located in a peculiarly well adapted region for sending. Her calls can be heard for much greater distances and much more distinctly than those of sending sets of equal power in other sections.

The first message was sent late in January and was relayed all over the country. I remained at my receiver every evening for two weeks, hoping against hope that I would receive some sort of a reply. One evening I had been listening to New Brunswick and it occurred to me to adjust my receiving set to a lower wave length; and as I struck 200 meters heard a faint call, recognized it as my own and heard an amateur at Van Wert, Ohio, trying to tell me something about my sister.

This amateur, who refused to disclose his

identity, told me my sister was living with a farmer at Rockford, Mercer County, Ohio. The Van Wert amateur had been trying to get me for two weeks but his sending set lacked the power. It happened that no amateurs were sending near Toledo at the moment and atmospheric conditions were at their best.

I immediately left to investigate. After a long trip by train and automobile I found Cleo, and recognition was immediate.

The set with which I was working at the time I found my sister consists of a receiving hookup of my own design, of which I hold the patent rights, both as to idea and design. The hookup is now in the hands of experts undergoing exhaustive tests.

One of the features of the receiving set is its property of highly selective tuning. Another is its compactness, coupled with the ability to gather signals from the most remote stations.

With my set, contained in a cabinet 3x10x17 inches, I have accomplished as much in receiving distant calls as other amateurs have with instruments of several times the bulk. I can receive all undamped waves and long distance amateurs without the addition of loading coils or amplifiers. The receiving hookup is in the larger cabinet of the illustration. I employ a two-step amplifier, with audiotron bulbs and a loud speaker to intensify signals. I have been able to hear Stavanger, Norway, at a distance of 150 feet with the amplifiers and horn. A special switching arrangement permits the amplifiers to be cut out by single steps, making possible the use of a single bulb. The aerial is composed of four wires, two feet apart and sixty feet long and forty feet high.

The sending set consists of a one-kilowatt E. I. Co. transformer, a home-made oscillation transformer, and a home-made copper-foil condenser. It has a high-speed rotary gap with a special motor working at 9,000 r.p.m., with full load, permitting the sending of messages for more than 1,000 miles. I also have a lower power transmitter for close range work.

Recently I have taken up radio telephony, making small change in the construction of my receiving set. I have had conversations with a Cleveland amateur, listening to his

(Continued on page 642)

Dancing By Radiophone

THE accompanying photograph shows in a striking manner some of Atlanta's elite young folks preparing to gracefully trot to the tune of "Dardanella." The unusual part of this event was the fact that music was radiophoned by a concert band nearly two miles away, the music being furnished by the Georgia Tech. Band and the event taking place on the roof of the Capital City Club.

As will be noted, each young man and his dancing partner are equipt with a pair of radio receiving head phones and connecting cords suspended from various parts of the room, thus enabling them to cover a considerable part of the floor. It will also be noted that the set was furnished with a loud-speaking telephone, whereby nearby persons not equipt with receivers could hear the music as well. Altho it had originally been planned to furnish music of sufficient volume for the entire membership of the *Club de Vingt*, which consists of 500 enthusiastic youngsters, it was not possible to accommodate them owing to the fact, as our radio men will easily appreciate, that the building was a steel one, having the tendency to absorb a great deal of the radiated energy and in addition to this the open air and the noise of the crowd did its share towards diminishing the received intensity of the music.

A few well-informed radio men who witnessed and assisted in the demonstration were, however, highly elated and declared that the "first radiophone dance was

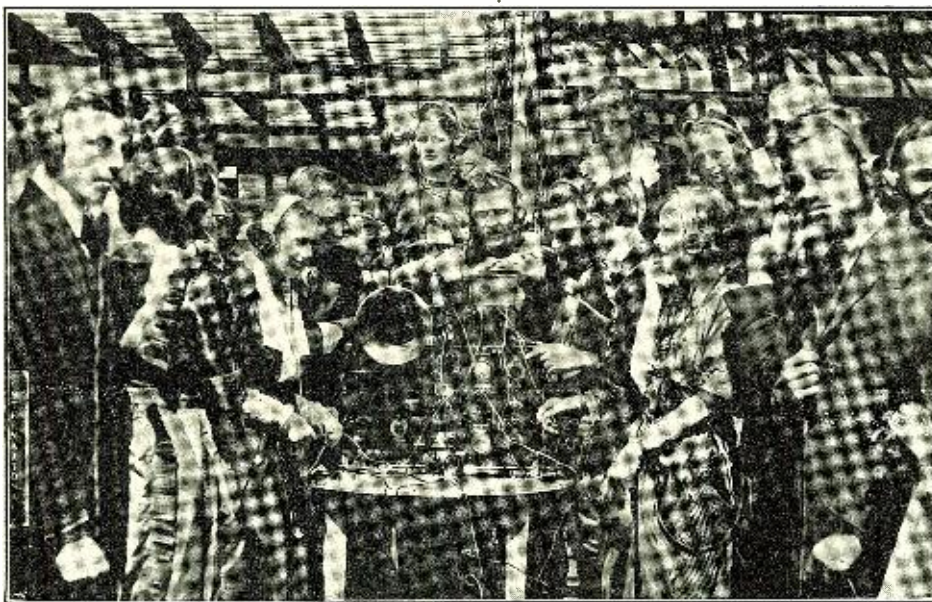

Some Promising Young Atlanta Folks About to "Trot" Along to the Tune of "Dardanella," Each One Equipt With the Familiar Headphones Whereby the Music Is Furnisht by Radiophone.

a huge success," and believe that the difficulties encountered can easily be overcome in future affairs of this kind.

Sergeant Thomas Brass, of the Georgia Tech. Signal unit of the Reserve Officers' Training Corps, is the radio man who prepared and installed the apparatus making the demonstration possible. According to a reported statement the following is the manner in which he conceived the idea of the radio concert.

An amateur station in Alabama which is on "speaking terms" with the Tech. station was having considerable trouble in hearing a radiophone conversation some time ago. After having the message repeated several times the Alabama operator was instructed to "sing it." Sergeant Brass, who has spent twenty-five years in the army and whose singing days are but images of the past, declined to vocalize in the manner sug-

gested, but promised to get a phonograph for him.

"You know," he said, "the idea struck me that it might actually be done. I tried it out with the ordinary transmitter but it wouldn't work, as not enough of the sound could be concentrated on the diaphragm of the transmitter. Then I got to work and experimented."

What Sergeant Brass actually "fixt" was a very sensitive diaphragm and a two-step amplifier receiving set. This was done only after several weeks of experimenting and hard work on the part of the entire signal units. The work was kept strictly secret until the initial tryout was given. An ordinary

phonograph was started, the transmitter set up, and—radio music!

On hearing the music one of the local stations promised to entertain another party of dancers, the music to be furnished by radiophone. This will necessitate some additional fixtures since at the present the sound does not carry far enough from the receiver for practical dancing purposes, and it would be necessary for each dancer to wear a receiving head set.

The possibilities of a dance were discust and Sergeant Brass is of the opinion that it would be possible with the proper arrangement of microphones. He intends to begin work on this in the near future. Until these improvements are made the pleasure of radiophone music will have to be confined to those who are fortunate enough to secure a head set.

The Latest in Crystal Detectors

Judging from the number of different types of crystal detectors on the market at the present time, it would seem that there is no room for further improvement, as there are some exceptional designs. Of the recent types, the general trend seems to be towards the enclosed type of detector which, as we know, has many advantages over the old type of dust collector. The photograph shows an advanced type of detector invented by Fred S. Hover, of New York, which seems to fill in the long wanted missing link. It incorporates the many advantages of other types of detector. One of the chief features is the provision made for reaching every part of the crystal employed in the apparatus with an extremely fine adjustment, which is at the same time rapid and rugged. The cat-whisker contact where used is of silver.

Another feature provided is a glass tube enclosure, thus rendering the operating parts free from dust and atmospheric conditions. The base is constructed of some insulating materials such as bakelite or hard

rubber, and mounted thereon are two brackets, shown at the extreme end. These brackets support the tubular section of glass which encloses the crystal. As shown in the photograph, the crystal is mounted at the

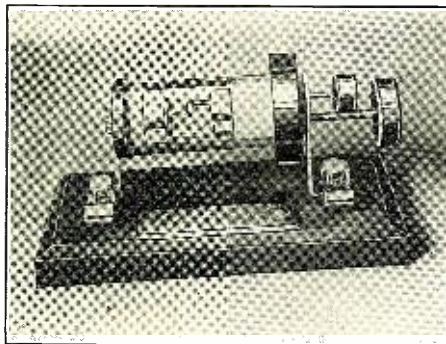

According to the Inventor, This Crystal Detector When Once Set Will Maintain Sensitive Adjustment for Long Periods.

left of the tube so that a slight pressure is maintained upon it by a spring in the rear which gives it a cushion effect. At the right of the photo the adjusting mechanism is shown. A plug having two holes as shown, is inserted in this end of the glass tube.

The upper knob and rod controls the minute movement of the contact points. That is, a twist of this knob will reach every part of the crystal within the radius of the point. The lower knob and rod controls the pressure of the contact upon the crystal. And last but not least, a wide adjustment is possible by the turning of the entire plug. It is seen from the foregoing that three adjustments may be had with a detector of this type. With its many other valuable features, it should prove to be a very popular instrument for the amateur. The inventor claims that this detector was used for a considerable length of time, during which it maintained the adjustments thru all sorts of jarring and disturbing conditions.

Navy Radio Again

CONSIDERABLE interest has recently been manifested thruout the country and particularly by the great amateur body, owing to the United States Senate's approval of a joint resolution to operate United States Naval radio stations for commercial uses. This bill would authorize the Navy to continue its war-time ship-to-shore radio traffic and to accept for transmission commercial and news messages at tolls not less than the operating cost. Publishers of large newspapers claim that unless the present Navy radio system is continued, it will be impossible to secure news dispatches from some of the European countries, the Far East, China, Porto Rico and other island possessions of the United States.

A number of amendments to the Senate bill, it was recently announced by Chairman Green, have been suggested. These relate to radio stations on the Great Lakes, ship to shore stations, particularly those located in and around New York and the Pacific coast navy wireless stations. An amendment favored by members of the committee generally would provide for the establishment of a cheap wireless rate on commercial messages between the foreign stations mentioned above.

Amateurs, however, need not be alarmed concerning the immediate results of such a resolution, even if actually placed in operation. In fact, it does not concern them, except that it will mean another very efficient source of securing information, code practise and other valuable training by "listening-in" to the immense high-power government stations, as well as to the answering signals of the distant foreign installations. For this reason it may be said that thousands of youthful radio aspirants may be interested in the accompanying photographs of part of the equipment and installation of the great United States Naval high power radio station at Radio (Arlington), Va.

The upper right hand photograph shows transmitter of NAA at Arlington, Va. At a general view of the power room and

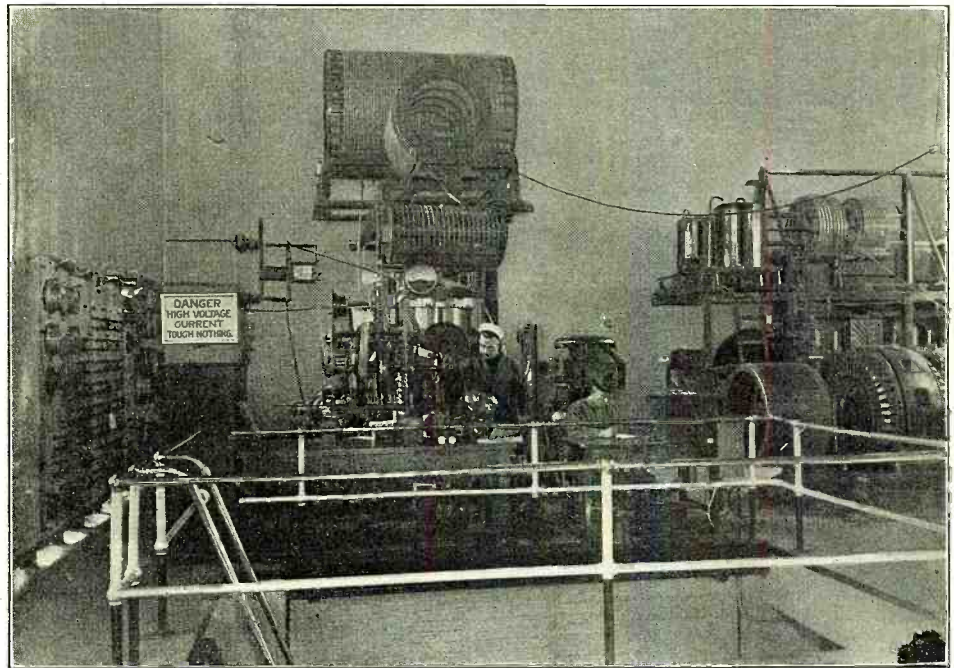

1. This Photograph Shows a General View of the Power and Transmitter Room of "NAA". The Marine Sitting at the Desk is Probably Thinking of the Girl He Left in France, While the Gob Standing Near the Oscillation Transformer Must Be Thinking of the Tropical Cruise He Missed By Being Detailed to Shore Duty.

the left of this photograph can be seen the control switchboards. In the center is shown the great 60 kilowatt Federal arc transmitter and other necessary arc appliances, while to the right may be seen one of the power generators.

In the left hand photograph we have a view of part of the power room containing the 100 kilowatt spark transmitter which practically everyone of our American radio amateur friends intercepts each night when this station transmits its usual time signals, weather reports and press items to the world at large.

Many expert amateur operators as well as scores of professionals owe a great deal of their "copying" speed to the practise they secured by "listening-in" to these high-power stations of Uncle Sam's.

Timely Data on Some European Stations.

Time G.M.T. A.M.	Call Letter	Station	Wave Length, Meters	Matter Transmitted
1.30	M.P.D.	Poldhu	2,800	Press Damp
5.00	B.Y.B.	Cleethorpes	4,000	Weather Reports
7.00	U.A.	Nantes	2,800	Various
8.00	P.O.Z.	Nauen	6,000	Press
8.00	P.R.G.	Prague	V'ri'us	Various
9.00	P.O.Z.	Nauen	4,000	Weather Reports
9.30	M.P.D.	Poldhu	2,800	Weather Reports
9.45	F.L.	Paris	3,200	Weather Reports
9.56	F.L.	Paris	3,200	Time Sigs.
10.02	F.L.	Paris	3,200	Sidereal Time
10.00	P.O.Z.	Nauen	6,000	Press
10.44	F.L.	Paris	3,200	Time Sigs.
11.00	U.A.	Nantes	2,800	Various
11.00	I.C.I.	Coltano	V'ri'us	Various
11.30	P.E.A.	Rotterdam	600	Telegrams
11.30	P.C.H.	Scheveningen	600	Telegrams
P.M.				
1.00	B.Y.B.	Cleethorpes	4,000	Weather Reports
2.00	P.O.Z.	Nauen	6,000	Press
3.00	F.L.	Paris	3,200	Press
3.30	I.C.I.	Coltano	V'ri'us	Press
4.00	U.A.	Nantes	2,800	Radios for U.S. Ships
5.00	B.Y.B.	Cleethorpes	4,000	Weather Reports
5.30	P.O.Z.	Nauen	6,000	Instct. from Ger. Govt.
9.30	M.P.D.	Poldhu	2,800	Weather Reports
11.44-49	F.L.	Paris	3,200	Time Sigs.

THEY "LEAK."

Foolish—Why does the grid leak?

Fresh—On account of the damp waves.

—C. R. MORRISON.

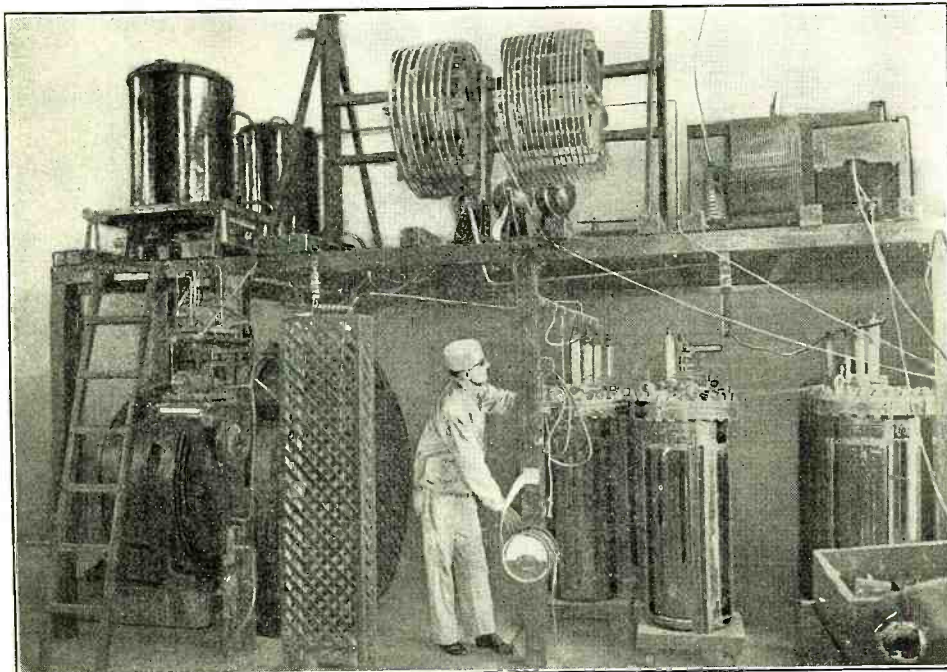

2. This Section "NAA" Is Part of the Power Room Where is Located the 100 Kilowatt Spark Transmitter Which Practically Everyone of Our Amateur Friends Intercepts Each Night When the Station Transmits Time Signals, Weather Reports and Press to the World at Large.

New Radio Apparatus

WE present to our readers an interesting little transmitter traveling under the name of the Vibratone Jr. Radio Transmitter. As its name infers, it is exceptionally well adapted for the beginning amateur and is a good starter, whether the amateur be a youngster of ten years or a grown-up man of forty. We say this in all seriousness, as it has recently been called to our attention that a great number of older persons, such as doctors, lawyers, chefs, bankers, truck drivers, machinists, club men and who not, are slowly filling the ranks of the great American amateur body.

This outfit is extremely simple in construction and the theory of its operation may be said to be based upon a buzzer impact arrangement and does not necessitate additional inductances, condenser or any other of the usual transmitting apparatus. In fact, it is a complete unit in itself.

It has six binding posts and all that is necessary to start it in operation is to connect two of the binding posts to an electric light circuit 110 volts either A. C. or D. C., two other binding posts to an ordinary telegraph key and the remaining two binding

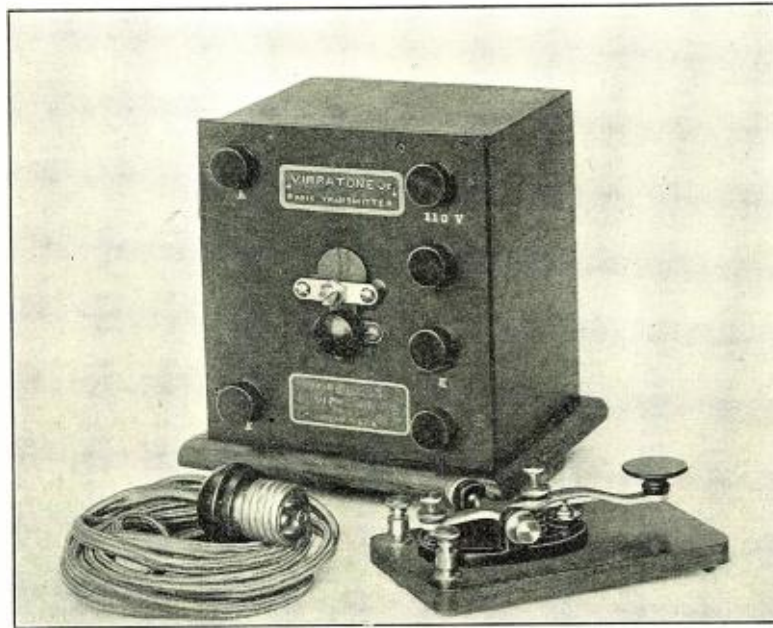

Here is Just the Transmitter for the Beginner to Start With. No Inductances, No Condensers, No Spark Gap to Bother With. Connect It to the House Lighting System and "Shoot" Away.

posts are connected to aerial and ground, respectively. Simple, isn't it?

This transmitting set which has recently been placed on the market by a well-known radio equipment company, operates directly on a house circuit, and it is complete, compact and completely eliminates battery cost. It can be operated from the electric

light circuit for about two cents per day. Its range and power are about the same as a one-inch spark coil outfit. It consumes from 15 to 25 watts.

This set is of the spark type, wherein the interrupter acts as the spark gap as well. No oscillation transformer need be used with this set. It transmits at slightly less than the natural period of the aerial as it contains a series condenser to prevent the grounding of the electric light circuit. The wave transmitted is very sharp when the vibrator is properly adjusted and when used in connection with an antenna of low resistance. Longer waves may be transmitted by connecting a helix in series with binding post A and the aerial. The note transmitted on direct current is about 150 cycles, and on alternating current is the same frequency as the power circuit.

Some of you amateurs who are contemplating a portable transmitter for your coming summer vacation days it may be suggested to you that this set is useful for such service, as it can be operated on four or five ordinary "B" batteries of 22 volts each. It is recommended for Scout use as well as for stationary purposes.

The Audio Oscillator

THE precision of most alternating current bridge measurements is in no small measure dependent on the source of power supplied to the bridge. The wave form should be strictly free from harmonics. Where a balance is indicated by means of the null method with a telephone receiver, the presence of harmonics of even very small magnitude will prevent the accurate determination of the balance point for the fundamental. The frequency must remain constant. The supply source should also be simple in its operation,

rugged and reliable. It was to meet these requirements that a Cambridge radio company known for the fine workmanship and accuracy of its products designed the audio oscillator.

The output of this oscillator is about 0.06 watt at 1000 cycles. External binding posts are so arranged that three output voltages may be obtained. The outputs obtainable with these three different connections are as follows:

Point	Voltage	Current
Low	0.5 volts	120 milliamperes
Medium	1.5 volts	40 milliamperes
High	5.0 volts	12 milliamperes

For some capacitance measurements it is desirable to use a high voltage. This increased voltage may be obtained by connecting an inductance and capacitance in series across the high voltage output terminals of the oscillator. By adjusting this circuit to resonance, voltages as high as 50 or 100 may be obtained by connecting output leads across the condenser. This instrument will operate satisfactorily on from four to eight volts. The input current is approximately 0.13 ampere. When running, the oscillator may be heard for a distance of approximately twenty-five feet, or may be made silent by enclosing in a sound-proof box.

The circuits of this oscillator are shown in the diagram of Fig. 1. The closing of the switch places the field magnetizing coil directly across the battery. Also across the battery is the primary of the input transformer in series with the microphone but-

ton. The resonance circuit consists of the secondary of the input transformer, the primary of the output transformer, the armature coil and the condenser. The output transformer secondary has three taps to permit the obtaining of three different output voltages. The use of the two transformers prevents the output wave from containing any direct current component.

(Continued on page 644)

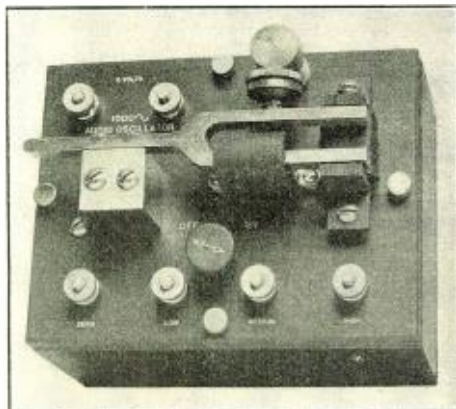

This Audio Oscillator Furnishes Pure Oscillations At a Frequency of 1,000 Cycles.

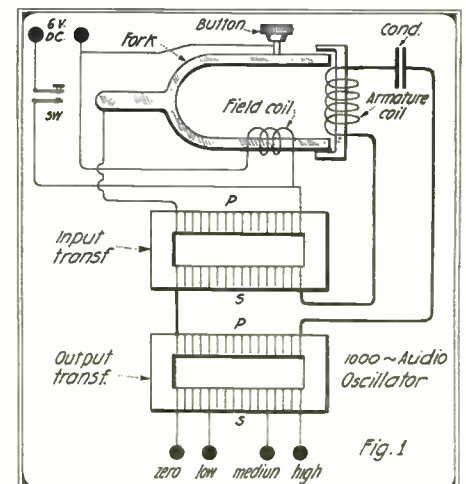

Complete Circuit Diagram of the Audio Oscillator.

New Foreign Radio Apparatus

WE are pleased to present to our readers a few illustrations of contemporary French and English radio apparatus, which are now being marketed by various foreign manufacturers. Now that the laws in Great Britain have somewhat softened towards the amateur, enabling him to experiment in receiving as well as probably in sending in the near future, our American readers may be interested in the type of instruments used by our amateur allies. Some of you may remark that the mostly used instruments such as detectors, keys and receivers are rather different in construction and make-up from those of the American manufacturers, on the other hand they may suggest improved ideas over our own. At any rate look them over.

FRENCH INSTRUMENTS WALL TYPE TIME SIGNAL RECEIVER.

This is rather a unique little receiver

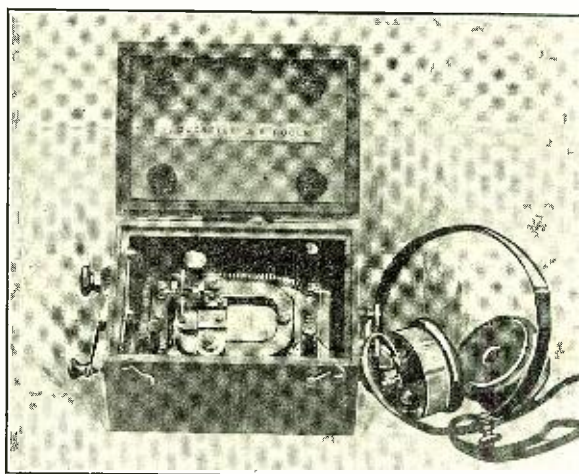

Fig. 5. This Polarized Relay Has Rendered Great Service in Many Ways and Particularly in the French Navy During the Recent Fuss.

wave to a large wavelength; the large one being of sufficient length to receive the time signals. All that is necessary to operate the set is to have the plane of the loop in line with the direction of the Eiffel Tower. French experimenters particularly like this style of receiver, as no aerial is required and all that is necessary is to place it on any dining room table.

COMPLETE VACUUM TUBE RECEIVER

As will be seen from figure 6, this is a complete three bulb receiver comprising detector, amplifier, and a generator of radio frequency oscillations which performs the office of heterodyning necessary for the reception of undamped waves. This rather complete VT unit makes possible very efficient as well as selective reception and is a favorite radio amateur instrument in France.

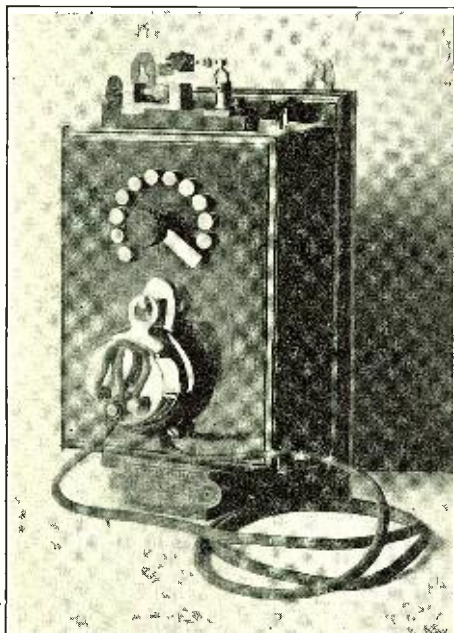

Fig. 1. This Time Signal Receiving Set May Be Fastened on the Wall Like an Ordinary Telephone.

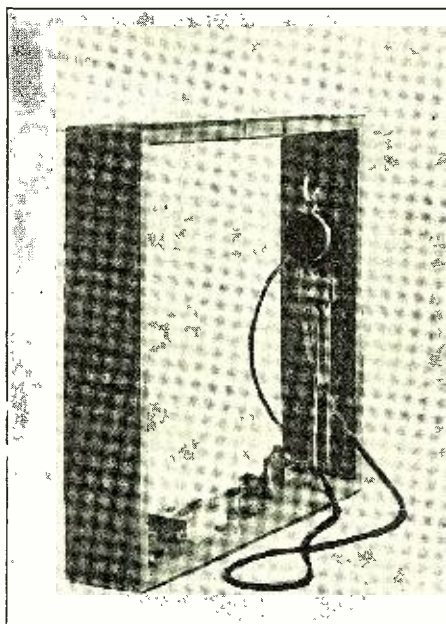

Fig. 2. Here We Have a Complete Loop Receiver Unit, Also Suitable for the Reception of Long Wave Time Signals.

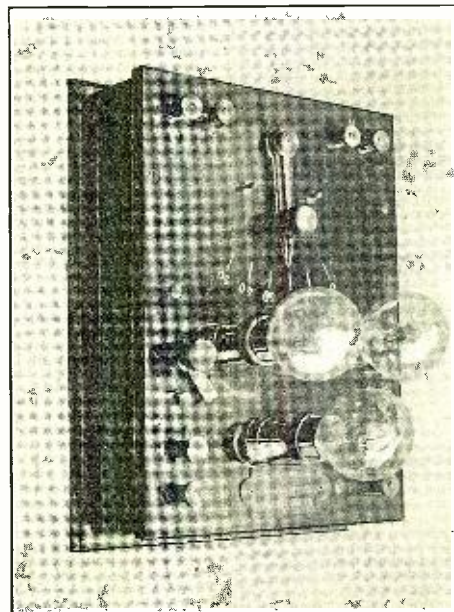

Fig. 6. This Three-vacuum Tube Set Comprises Detector, Amplifier as Well as Generator of Oscillations at High Frequency.

ing outfit and is shown at Fig. 1. It is very simple of operation and is specially designed for postal and telegraph service as well as for jewelers in securing daily time signals transmitted by the powerful Eiffel Tower radio station. The set is nothing more than an inductance tapt to a twelve point switch, a galena detector, a small fixed condenser and a 2,000 ohm receiver. The detector employed may be seen at Fig. 3.

LOOP RECEIVER.

As may be seen from Fig. 2 the complete receiving instruments are installed within a frame of the loop, which is quite an advantage for the receiver may be carried from place to place in exceptionally easy

manner. This set is also designed for the reception of time signals transmitted by F. L. at Paris. The instruments comprised here are the same as those contained in the wall type receiver previously mentioned. In this case, however, a double-pole switch makes it possible to change from a small

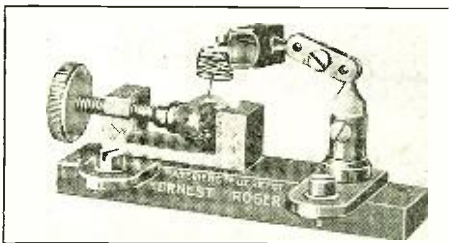

To the Left is Fig. 3, Showing a Galena Detector Having a Very Supple Contact as well as Universal Point; While to the Right is Fig. 4, Showing a Practical Tikker for the Reception of Undamped Waves.

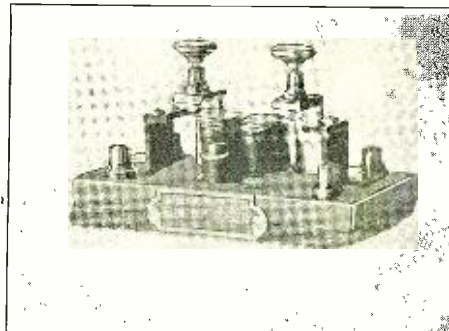

A PRACTICAL TIKKER.

This instrument is designed for the reception of undamped signals, and is the notorious piece of apparatus we frequently hear about but seldom see on the market. The instrument consists of two sets of electro magnets. The first is connected to a small battery, thus setting its armature into vibration while the second set through its vibrating armature and contact point produces periodical interruptions in the receiving circuit and therefore "chops up" the undamped signals so that they made be heard within audio frequency in the telephone receivers. A photograph of the instrument is shown at Fig. 4.

POLARIZED RELAY.

This instrument
(Cont'd on page 660)

AWARDS OF \$100 RADIOPHONE PRIZE CONTEST

FIRST PRIZE WINNER

With this issue, we announce to our readers the prize winners of our \$100 Radiophone Prize Contest.

Now, Boys, we must admit a certain lack of enthusiasm shown, that is to say, judging from the number of entries. The radiophone is such a momentous subject to-day, and practically every amateur has built, is building, or expects to build a radiophone, that we thought surely there would be plenty of participants. However, it would seem that altho this is a fact, many were evidently frightened at the word "contest," believing that so many entries are made that there is very little show for any individual amateur. Possibly the literary end frightens them away. This is certainly a mistake, and in future contests, our readers should bear in mind it is not necessary to send in a finished and exact manuscript, as our editors will take care of that end of it. Neither is it necessary to send in professional drawings or photographs, but, of course, the better these are as to detail and clearness, the better chance for the entries.

Some of the ones we did receive, however, were excellent and particularly the one winning first prize. This paper was excellently executed and was accompanied by some exceptionally clear and good photographs. Even so, Mr. Harmon, almost apologized for sending the effort in, believing that it could be much better. This is our reason for surmising the general timid attitude inferred above.

A Practical Radiophone for the Amateur

By HERBERT W. HARMON

THE wireless Amateur, the real Radio bug, is characterized as having his mental mouth always wide open for every new thing that comes his way. So the radio telephone for about a year has been one of the next new things he has had rumors of, and yet has been vaguely just out of his reach. The last few months he has been asking for more real practical information, on a working radio phone that will cover distance. Across town talks, or five or ten mile ranges have not met his idea of real work.

With this call of surrounding amateurs in our ears for several months back we have, at odd moments been trying to design a working wireless phone combination together using apparatus at hand and made up largely out of the apparatus commonly found in the fairly well equipped amateur's station. This we now have successfully accomplished by making use of the following pieces of apparatus:

Description of Apparatus.

1. To supply the Plate voltage, a Bodine Elec. Co. Motor Generator is used. Generator voltage—650, D. C. at 1750 R. P. M.

PRIZE WINNERS

First Prize \$50.00 in Gold

Mr. HERBERT W. HARMON
Grove City College
Grove City, Pa.

Second Prize \$25.00 in Gold

Lieut. W. L. WINNER
General Hospital No. 2
Ft. McHenry, Md.

Third Prize \$15.00 in Gold

Mr. ALBERT H. RODDE,
1516 Emmons Ave.,
Sheepshead Bay, N. Y.

Fourth Prize \$10 in Gold

Mr. N. G. HERRESHOFF, JR.,
149 High St.,
Bristol, R. I.

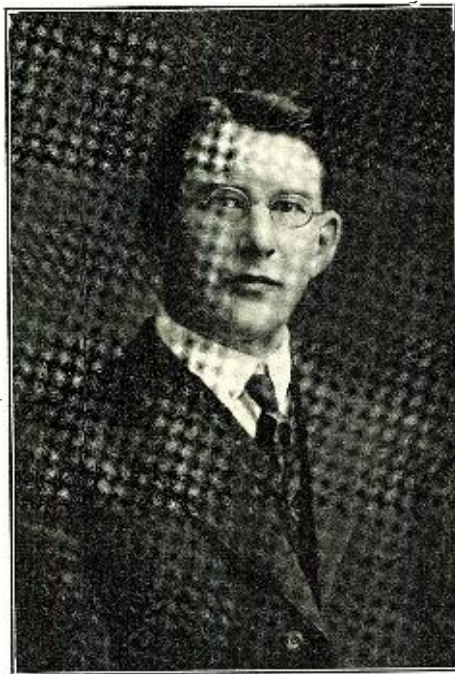

PRIZE WINNER.
Mr. Herbert W. Harmon

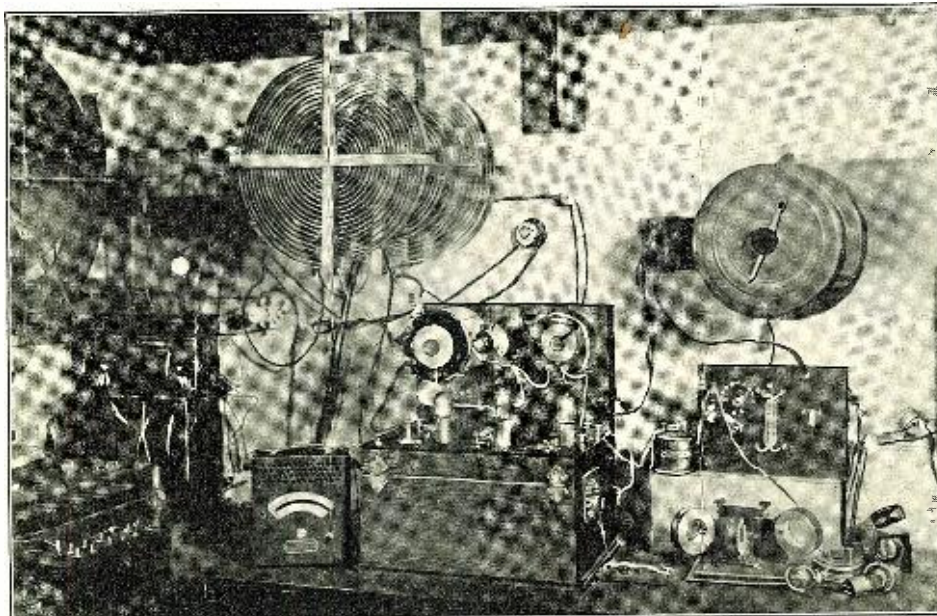

This is a General View of Mr. Harmon's Prize Winning Radiophone Station

of the 12" x 18" cabinet Panel showing the wiring diagram. SSS are the three sockets, slotted to receive either the VT-1 or VT-2 tubes. RRR are the filament control rheostats for

Output 1.35 amp. Motor 60 cycle 120 volts.
2. Three Marconi VT-1 Class 2 Vacuum tubes at \$7.00, with 3 VT-1 Marconi sockets at \$1.50, or 3 VT-2 Western Electric Tubes at \$15.00.

3. Acme Apparatus Co. Cambridge, Mass. Modulation Transformer at \$7.00; this shunts, the grid condenser.

4. Loud speaking telephone transmitter at \$1.50, Electro Importing Co., New York.

5. Two storage batteries at \$10 to \$15 each or, Dry Cells may be used for transmitter bulbs.

6. Three oscillation transformers 16" in diameter using 3/4" brass strip. Spacing 3/8" apart. Seven out-side turns used in each primary; five to eight turns used in secondary.

7. Two variable air condensers: such as DeForrest .0015 Mfd. at \$17.00, or General Radio No. 182a of .0007 Mfd. at \$10.00, or Murdock .001 and .0005 Mfd. are nearly as good.

8. 1 doz. flash light cells at \$3.00, for producing variable grid voltage by use of contact points and switch arm.

9. Three battery, Remler, variable rheostats @ \$1.50.

10. A filament D. C. No. 30 Weston ammeter 0-1.50 amp. @ \$7.00. A plate D. C. No. 301 Weston Milli Ammeter (0-300) @ \$7.00.

11. Two hot wire Eldridge ammeters of range 1-1.00 and 1-5.00 amperes at \$4.50, for use in primary and aerial high frequency circuits.

12. One variable graphite, high resistance (1-100,000 ohms.) Used in series with the generator's shunt coil to regulate the plate voltage, \$1.50.

13. Light telegraph key to operate buzzer or grid \$1.50.

14. Two 2 M. F. paraffine condensers to shunt generator leads @ \$1.50.

15. Two choke coils to be used in series with generator leads to smooth out commutator ripple. A home made one will cost \$2.00.

16. A high tone buzzer with large contacts and connecting leads used in series with the aerial to ground, to chop up the high frequency current when sending by key. A home made one will cost \$2.00.

17. Switches, binding posts and Bakelite panel. Cabinet box of oak.

Total Cost \$175-\$200.

The particular use of each of the above pieces will be readily understood by reference to Fig. 1, by the amateur who has reached that point in radio work, where he wants to experiment with the radio phone. Fig. 2 shows the top view

each tube. MA and A are the plate filament current ammeters; WS is the wing switch which puts the ammeter A in Series with the filament of each tube separately. Sg is the switch which regulates the potential of the grid by altering the number of the cells used in the grid battery; (Bg), placed inside of the cabinet. Also in the cabinet under the panel is CM, CM the group of 2Mf. condensers shunting the positive and negative terminals of the motor generator, and the battery for operating the telephone transmitter. The motor generator field rheostat is mounted on the left end of cabinet not visible in cuts.

By referring to the several cuts it can be seen that the oscillating circuit consists of $\frac{3}{4}$ " brass ribbon and heavy copper woven braid with all joints soldered thus *reducing ohmic resistance loss to a minimum*. A knife switch for shorting the hot-wire ammeter, help to further reduce this loss.

The wiring up of the bakelite panel was done with rubber covered No. 14 copper wire with every connection, without exception, soldered, thus reducing resistance and doing away with questionable contacts. The front mounting of the two variable condensers, rather than flush mounting, is due to their use in other experimental work about our radio laboratory.

The oscillating circuit shown in the hook-up of Fig. 1 is one often given in the latest text books and magazines as a generator circuit of high power and a *persistent* oscillator. In fact, the writer, at the Bureau of Standards in the summer of 1918, with a slight modification of this circuit, obtained from a single plitron tube a current of 65 amps. in the coupled circuit, and over 100 amps. with the use of three tubes. Our present hook-up is giving us a maximum current of over 4 amperes in the primary circuit with one VT-2 Western Electric tube and .6 amperes in aerial, and, with three tubes six amperes and 1.25 respectively; three tubes of Marconi VT-1 class 2 type give 3.5 and .6 respectively. The wave length is readily controlled by the variable condenser Cp and the number of turns in L1 and L2. The number of turns in L1 and L2 are to be approximately equal and must not be too few in number or modulation, and oscillations cease; we have found 7 outer turns the best to use. The coupling should be sufficiently loose between L1 and L2 with L3

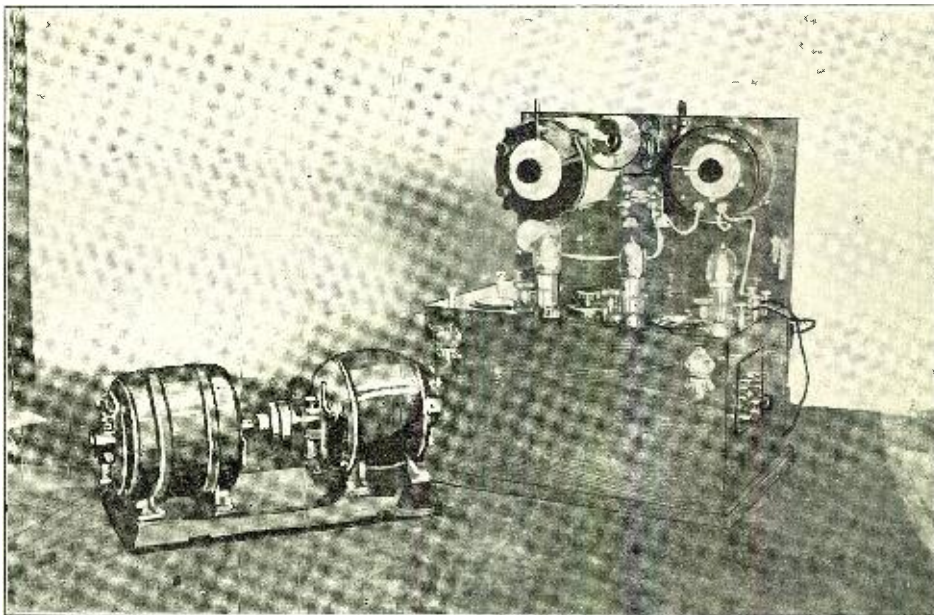

This Photograph Shows a Close-up of the Radiophone Transmitter Unit, as well as the Motor-Generator Employed to Secure the Necessary Plate Potential.

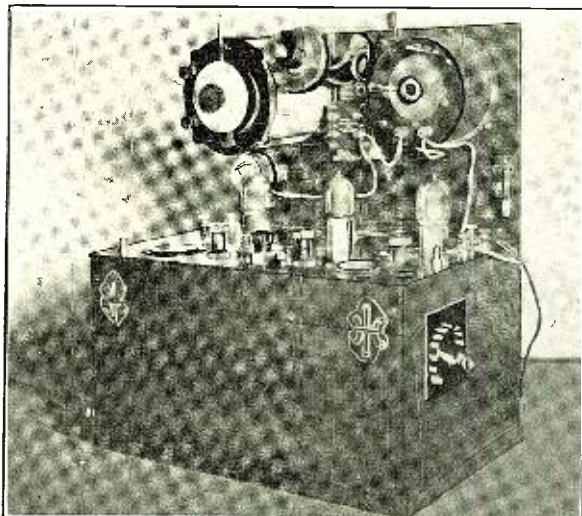

A Closer View of the Transmitter Unit. Note the Well Planned Construction.

midway between them in order to keep the radiated wave sharp. We are using about 18" separation. Hot wire ammeters in both the primary and aerial circuit measure the strength of the oscillating currents. The modulation of these currents is accomplished by the telephone transmitter and Acme step up transformer, the secondary of which has a D. C. resistance of about 15,000 ohms. This latter serves as the grid leak, and may need to be supplemented by a graphite resistance if this transformer secondary has too little resistance. We have found the Acme modulation transformer needs none.

The conditions for modulation are moderately critical but can be readily found by listening in on your own audion receiving set adjusted to sensitiveness for your own radiated wave, while varying the grid condenser Cg. We find this usually near the 30 point of the General Radio Co. condenser (.0-0007), or capacity about .0002 mfd. Also the grid battery Bg with its (-) terminal connected to the grid, needs to be varied to

get the oscillations to occur on the straight line part of the tube's grid voltage characteristic curve. If this is not done, the articulation will not be good. Both of these adjustments depend slightly on the temperature of the filament and on the plate voltage supplied by the generator G. The Western Electric VT-2 tubes require from 30 to 40 volts (7-10) cells. While the Marconi VT-1 class 2 tubes use from 13 to 18 volts (3-5 cells) in the grid current. The Marconi VT-1 socket, if slotted $\frac{1}{8}$ " to the left of the regular slot, will correctly receive the Western Electric V.T.2 tubes.

The individual characteristics of the several tubes used in parallel as shown in Fig. 1, should be closely similar for good modulation. The tubes, as now manufactured, so well meet this condition that little trouble due to this cause should be encountered.

The filaments of the several tubes should be separately adjusted to their required current Ia; and this can be done by the wing switch (Sw), and variation of R; this is 1.35 amperes for the VT-2 and .8 for the VT-1 class 2 tubes.

The hum of the generator due to the

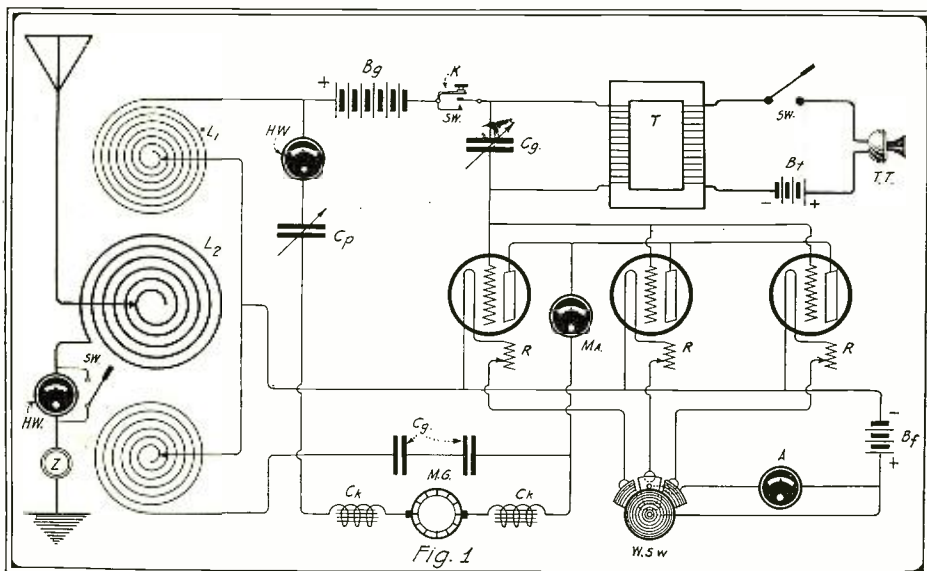

This Diagram Shows the Schematic Hook-up of the Set and Is One taken from Leading Text Books and Magazines. It is a Circuit of High Power and a Persistent Oscillator.

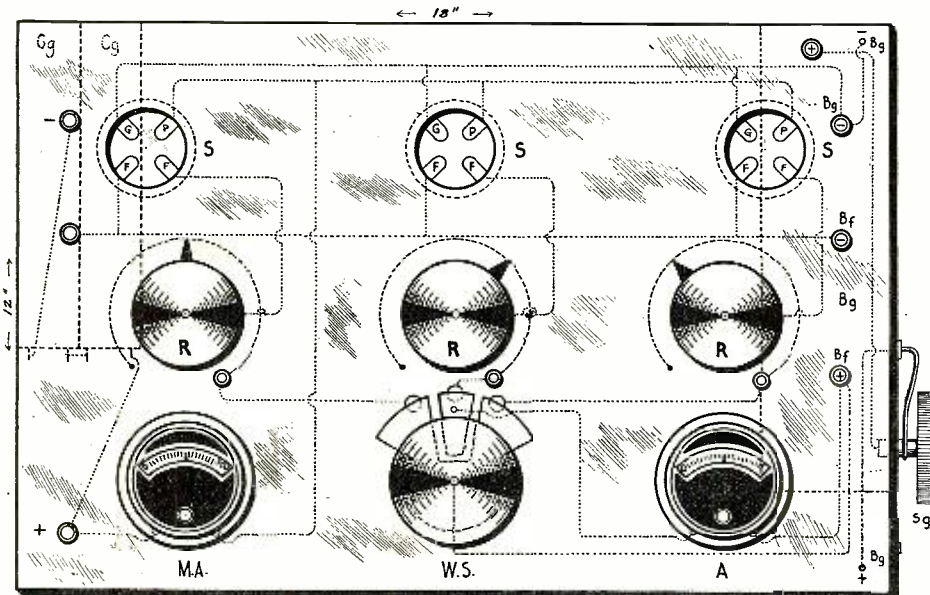

Fig. 2

This Drawing Shows the Top View of the 12" by 18" Cabinet Panel as Well as its Wiring Diagram.

commutator ripples can be largely smoothed out and done away with, by use of the large capacity (2MF) condensers Cg and the choke coils Ck; the larger both of these are the better.

With this outfit, using VT-2 tubes, during the last month or two we have been talking with neighboring amateurs, at New Castle, Pa.; 8Ha, 25 miles Monaca, Pa.; 8DV, 60 miles, Erie, Pa.; 90 miles, Youngstown, Ohio; 8Ha, 25 miles, Niles, Ohio; 8EM, 70 miles, etc., and others reported having heard us as far as 200 miles distant. Victrola music, by use of loud speaking horn, has been quite frequently sent out with all of these stations first, being given the "QST" notice with our spark set, and thus many of the western Pa. and eastern Ohio amateurs have listened to the concert at the same time.

Thru the use of a high tone buzzer as a "chopper" of the high frequency currents in the aerial circuit at Z of Fig. 1, distances considerably further are being reported. This buzzer for Morse code, key sending, is started and kept in continuous vibration and the grid key is used to control the high frequency oscillations of the tubes. Its shrill tone, together with the undamped (CW) oscillations seems to have wonderful carrying powers.

The Marconi VT-1 class 2 tubes which radiate about one half as much, are being heard by most of these same stations tho of course more faintly.

Referring to the data on the tube tests, which appears on this page under a suitable heading, it is seen that the Marconi VT-1 class, 2 tubes, safely take a filament current of .82 amperes and plate voltages up to 575, which is the voltage limit of our motor generator. The currents produced rise rapidly with an increase of plate-voltage. At .70 amperes filament current which is used for amplifier work, they generate very feebly or not at all. The VT-2 using 1.35 amperes filament current generate more than twice the current that the Marconi VT-1s do. The tests on the several individual tubes show their uniformity and what can be expected from them, when they are employed indi-

(Continued on page 666)

Data on Tube Tests

KIND	No.	Filament Current	VOLTAGE		CURRENTS			
			GRID (Eg.)	PLATE (Ep.) Volts	PLATE (Ip.)	PRIMARY Amps.	AERIAL Amps.	
Marconi VT-1 Class 2	1	.82	12V	325	20 M.A.	.5	.02	
	1	.82	12V	400	35	.75	.05	
	1	.82	12V	500	40	1.00	.12	
	1	.82	12V	575	43	1.10	.12	
	2	.82	12	325	40	1.50	.15	
	2	.82	12	400	50	1.65	.17	
	2	.82	12	500	55	1.65	.22	
	2	.82	12	575	Tube	blue glows		
	3	.82	12	325	10	.25	0	
	3	.82	12	400	20	.50	.02	
	3	.82	12	500	28	1.00	.05	
	3	.82	12	575	30	1.10	.10	
	4	.82	12	325	20	.80	.02	
	4	.82	12	400	28	1.10	.08	
	4	.82	12	500	28	1.10	.08	
	4	.82	12	575	32	1.10	.10	
Western Electric VT-2	2	1.35	40V	325	70	2.70	.56	
	2	1.35	40V	400	95	3.50	.67	
	2	1.35	40V	450	100	3.80	.89 Heated	
	3	1.35	40	325	40	2.00	.30	
	3	1.35	40	400	50	2.50	.40	
	3	1.35	40	500	75	3.40	.60	
	4	1.35	40	325	50	2.25	.35	
	4	1.35	40	400	70	3.00	.60	
	4	1.35	40	500	90	3.80	.90 Heated	
	Marconi VT-1 Class 2. In Parallel	1 & 2	.82	12	325	80	2.20	.36
		1 & 2	.82	12	400	88	2.60	.45
		1 & 2	.82	12	500	100	3.10	.50
1 & 2		.82	12	575	Generator overloaded			
1 & 3		.82	12	325	55	1.90	.30	
1 & 3		.82	12	400	60	2.10	.30	
1 & 3		.82	12	500	65	2.30	.35	
1 & 3		.82	12	325	68	2.10	.30	
1 & 4		.82	12	400	68	2.20	.30	
1 & 4		.82	12	500	72	2.60	.40	
1 & 4		.82	12	575	Generator Overloaded			
3 & 4		.82	12	325	45	2.00	.30	
3 & 4		.82	12	400	50	2.20	.30	
3 & 4		.82	12	500	55	2.35	.35	
1, 3 & 4		.82	12	325	75	2.30	.42	
1, 3 & 4		.82	12	400	80	2.70	.46	
1, 3 & 4		.82	12	465	90	3.00	.55	
1, 2 & 3		.82	12	325	90	2.60	.50	
1, 2 & 3		.82	12	400	90	2.80	.55	
1, 2 & 3		.82	12	450	110	3.00	.65	
Western Electric VT-2 In Parallel		2, 3 & 4	1.35	40	325	100	3.10	.85
		2, 3 & 4	1.35	40	400	135	4.00	1.11
		2, 3 & 4	1.35	40	450	140	4.30	1.25

This Interesting Table Shows Some Vacuum Tube Data Secured by Mr. Harmon, and Mentioned in the Text.

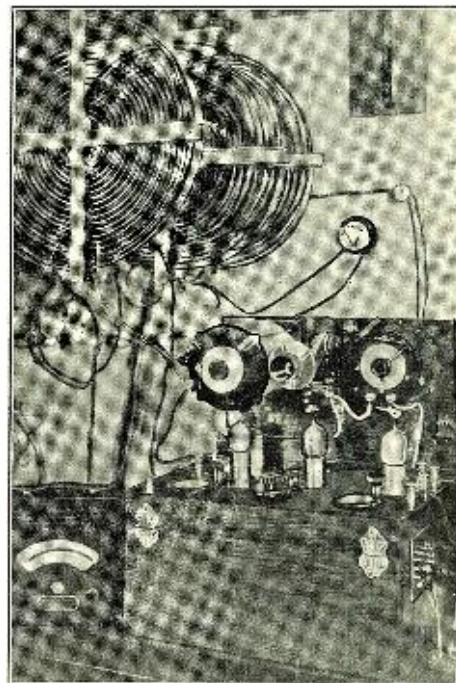

This Photograph Shows the Three Oscillation Inductances Used in This Set. They May Be Constructed With Ordinary 3/4" Brass Strip or Ribbon and Mounted on Composition or Hard, Well-Seasoned Wood.

Variometers

By S. M. EDWARDS

THE variometer is an instrument about which perhaps more has been said and less has been understood than any other single instrument with which the amateur is concerned. The name variometer is an ex-

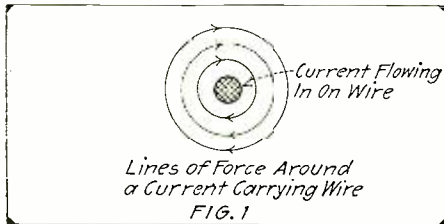

Showing the Direction of Lines of Force When a Current Is Passing Through a Wire.

ceedingly poor one, as it conveys no idea as to what the instrument really is, and for the sake of the uninitiated it may be stated here that a variometer is nothing more or less than a continuously variable inductance coil, or tuning coil, and is used for the same purposes as the ordinary tuning coil is. Just as there are fixed condensers, condensers that are varied step by step, and continuously variable or rotary plate condensers, so there are fixed inductances, tapped inductances, as the secondary of a loose coupler, and continuously variable inductance or "variometers." A variometer is not a meter in any sense of the word, as one might be led to think from the name.

A variometer in general consists of one fixed and one movable coil, connected in series, and so arranged that the coupling between the two coils can be varied. Varying this coupling changes the inductance of the combination. In order to thoroughly understand how this action takes place a working knowledge of the properties of electro-magnetic fields is necessary.

An electro-magnetic field may be defined as a displacement or a strain in the ether immediately surrounding a current carrying conductor that forms the center of the field. Or, plainly speaking, whenever a current flows thru a wire or other conductor, it sets up a strain in the ether, in that vicinity. This strain or displacement is called the electro-magnetic field, and continues as long as the current flows. For convenience, this field is considered as being made up of a number of lines, called electro-magnetic lines of force. Obviously, the direction of the strain will depend on the direction of the current, and when the current reverses in direction the strain set up by it is also reversed in direction. Therefore, these lines of force must be given a certain direction for each direction of the current. Electro-magnetic lines of force consist of an ever-expanding series of circles having their common center in

the center of the conductor (Fig. 1). The direction of the lines is determined by the right hand rule, which is as follows: If the conductor is grasped in the right hand, with the thumb extended in the direction in which the current is flowing, the fingers will encircle the wire in the same direction as the lines of force. In Fig. 1, the current is flowing in on the wire, and the direction of the lines of force, or of the field is indicated by the arrows. The strength of this field varies inversely as the square of the distance from the conductor. Thus, if another wire were placed parallel to the first one at a distance of one inch, a certain voltage would be induced in it from the first wire, say one volt. If now it is moved away to a distance of two inches, only one quarter of a volt would be induced in it, other things remaining the same.

If the wire is now wound on a cylindrical form, the ether in the vicinity of the coil is going to be affected by a great many wires instead of by only one, and the shape and strength of the resulting electro-magnetic field will be the result of the strains set up by each wire. It is the shape and strength of this field that we are concerned with when designing a variometer.

Fig. 2 shows a section of a coil wound with double cotton covered wire. The insulation is not shown in the figure, but the turns are spaced sufficiently to allow for it. Such a coil as this is common in radio

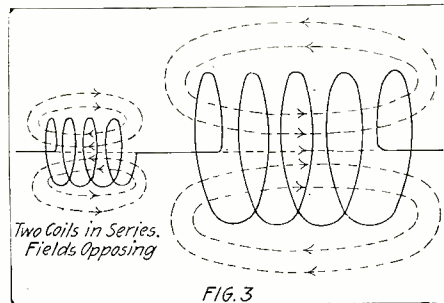

Direction of Lines of Force of Two Coils in Series With Fields Opposing.

receiving circuits. The lines of force set up by each turn of wire in the coil are in the same direction as the lines set up by all the other turns. Then on the outside of the coil, and on the inside, the lines will be aiding each other, but between any two turns the lines from one wire are in the opposite direction to those of the turn next to it. This means that in this particular part of the coil the current in one wire is trying to displace the ether in a certain direction, while the current in the next turn is trying to displace it in the opposite direction. The current in each turn is the same, therefore the effect of each will be the same, and at this particular point the two effects will neutralize, and there will be no field set up in that part of the coil. If the turns are spaced somewhat, as is the case in a coil having double cotton insulation, the fields set up by each turn will neutralize only at a point half way between the two turns, and between this mid-point and the wire a small field will be created. This is known as the "leakage field," but in all of the common types of receiving coil it is small enough to be disregarded.

The field set up by the coil as a whole will then be the result of the interactions of all these smaller fields. The dotted lines in Fig. 2 represent the resultant field of the whole coil, and as it is seen that the "leakage field" is not a part of this re-

sultant, it is desirable to keep the leakage as small as possible in order to concentrate the whole. The reason for this is that the resultant field is the only one that is capable of acting on another coil which may be coupled to this one, and when the

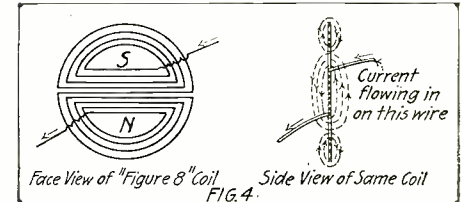

Two Coils in Series With the Fields Opposing Form a "Figure 8" Coil, as Shown Here.

strongest possible action on another coil is desired, as is the case with a variometer, the successful design of the whole instrument will depend on these small factors.

The strength of the fields set up by different coils is measured in terms of the inductance of the coils, the inductance depending on the diameter, length, number of turns and spacing of turns on the coil. The unit of inductance is the henry, but for radio coils the microhenry, one millionth of a henry, is usually taken. As the inductance is a measure of the strength of the electro-magnetic fields set up by different coils, it follows that when the inductances of two coils are the same, the fields set up by the two coils are equal in strength. For example, the field set up by a coil wound with 152 turns of No. 24 D.C.C. wire on a tube 3 inches in diameter would be exactly equal to that of a coil of 67 turns of the same wire wound on a 6 inch tube. The shape of the two fields would, however, be different, the field of the 3 inch coil being longer than the other.

Suppose now that these two coils are connected in series in the same circuit, and are so arranged that there is no interaction between their fields. In other words, assume that they are not "coupled." The electro-magnetic field of the whole circuit would then be the sum of the fields of the two coils, or twice that of one coil. Suppose the directions of the fields are as indicated by the arrows in Fig. 3, and that the smaller coil is gradually slipped inside the big one, the same as the secondary of a coupler is put inside the primary. As the coils get together, the ether in the vicinity of the two coils is acted on by each coil. The fields of the two coils oppose each other. Therefore, the resulting field will be less than it was before the coils were coupled. As the coupling is tightened, the resultant field will continue to grow smaller and it will reach its smallest value when the center of the small coil is exactly in the center of the large one.

(Continued on page 656)

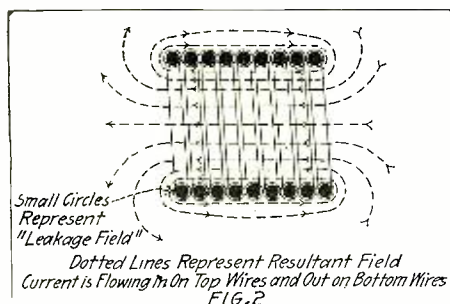

Here is shown the Lines of Force Around an Inductance of the Solenoid Type.

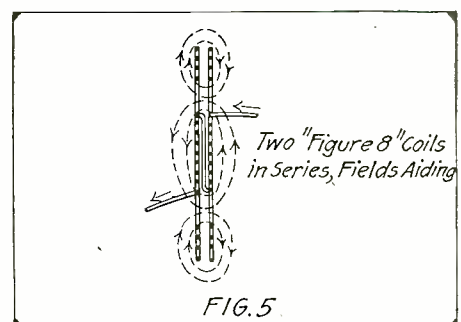

A Variometer Consisting of Two "Figure 8" Coils in Series.

Prize Station of W. L. Kaehni

One of the Many Excellent Stations Recently Entered in the National Contest Inaugurated by the Cleveland Press

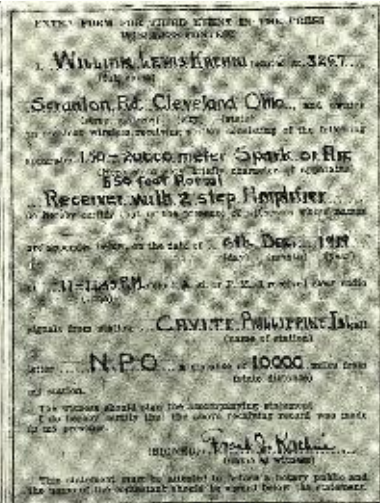
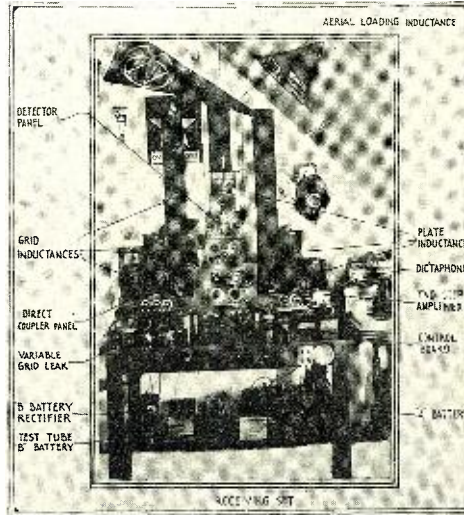

To Left, Photo of Mr. Kaehni; Center, Receiving Station; to Right, Copy of Affidavit Testifying to 10,000 Mile Reception.

THE accompanying photographs and diagrams are practically self explanatory. The radio station consists fundamentally of a receiving and transmitting set with two independent antennae of 550 and 90 feet lengths, respectively.

The receiving set is both simple and flexible, yet very efficient and stable in operation. In the design and construction of this set the writer has paid particular attention to details, such as silver plated contacts, thoro insulation and the elimination of all losses, for both short and long wave reception. An outstanding feature is that the single bulb on the detector panel acts as detector, oscillator and amplifier, for damp or undamp waves varying from 150 to 20,000 meters in length, without the necessity of complicated switches or the removal of inductances. This circuit is coupled with the two-step amplifier by the movement of the single switch on control panel, and under these conditions practically all of the high-powered stations of the world have been copied. Cavite, Philippine Islands, Hawaiian and European stations are heard distinctly. By means of control panel plugs the amplifier output may be connected with a loud speaking phone, which makes it possible to hear many American arc stations more than 50 feet from the room during any part of the day. It may also be connected with the dictaphone for making permanent records of signals. The set is used furthermore for short distance radiophone transmission.

An outstanding feature of the transmitting apparatus (not shown in photo) is the rotary gap, which has eight sparking surfaces in series. This produces a rapid quenching effect and thus combines the efficiency of the quenched gap with the pleasing musical sounds of the rotary spark gap. The lower transformer is of unusual design and exceptional efficiency.

Practically all of the apparatus in this station has been designed and

constructed in the writer's workshop.
W. E. KAEHNI.
3267 Scranton Road, Cleveland, O.
Ed. Note: Reports which recently reached us showed remarkably well posted contestants throught the United States.

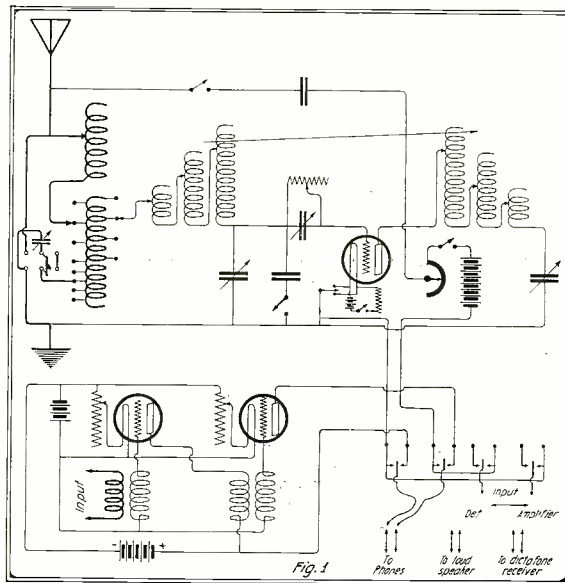

This is the Receiving Circuit Employed by the Owner of This Excellent and Well Appointed Station, Which Intercepted the Long Distance Signals.

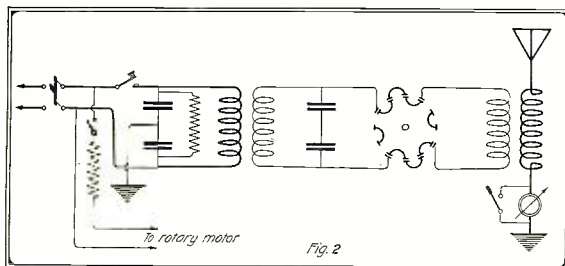

This Diagram Shows the Schematic Hook-up of the Kaehni Transmitting Station.

Winner of National Prize Radio Essay

James Collins of Cleveland, Ohio, was awarded the special prize, a \$150 wireless receiving outfit, in the wireless contest conducted by The Press, in co-operation with associated newspapers throught the country.

Collins was awarded the prize for his essay, "The Wireless Amateur." "Due to the war the progress of wireless telegraphy in the last few years has been very rapid," Collins wrote in part of his essay. "But even with the restrictions imposed during the war, the amateur has kept abreast of the times.

"The lifting of the restrictions saw him turn with a will to the task of erecting his apparatus and bringing it up to date.

"During the war the demand for wireless telegraph operators in the army and navy was great and we should not have been able to carry on as we did but for the response of the trained amateur to the needs of his country.

"The interest of Sir Oliver Lodge in the work of the amateur is greatly appreciated. And it is hoped that it will continue, for the amateur of today is the Lodge, De Forest and Fleming of tomorrow."

Collins is 18. He is employed by the Bailey Meter Co.

He formerly attended East Tech. He plans entering college next year.

National judges, who have the awarding of \$1,084 in prizes for the three events among entries received all over the United States, are to meet in New York April 10.

- They are:
J. S. NEWMAN.
DR. LEE DE FOREST, wireless inventor and member of the Institute of Radio Engineers.
ELMER E. BUCHER, instructing engineer of the Marconi Wireless Telegraph Co.

Ideas—Fifth Spasm

By THOS. W. BENSON

IT is about time we were taking a look at the transmitter in our quest for fame and fortune in the realm of invention. There is lots of room here for improvement so we will only consider forms of low power transmission at this

the kick of the inductance and set the aerial oscillating. When used as an auxiliary to a transformer set the condenser could be normally shorted by a switch and the interrupter set cut in as desired. A method of doing this is shown in figure 1.

A second method of hooking up the apparatus is also shown. Here we have the inductance coil in the aerial circuit that will give us low frequency oscillations in the aerial circuit. Not as good for radiation but it might do some work, I don't know.

It's nothing more or less than a "wet" buzzer that operates, so they say, at about 8,000 interruptions per sec. so it ought to give a good note when she gets tuned up properly. If you are one of those low note enthusiasts you can choke her down with inductance till it sounds like a discouraged one lung motorcycle hitting now and then.

But maybe you are a "dry man", good, I mean all right. Instead of using a nice smelly electrolytic try a Pinwheel Arc Transmitter. The arc is made by mounting a number of steel strips cut from clock spring steel around a disk in a manner similar to a rotary gap. Fasten them solid lest someone be troubled with collecting your insurance. For stationary electrodes use two carbon rods from an arc lamp so arranged that the steel strips strike the carbons in revolving.

Hook 'er up to an inductance as per diagram of Fig. 2 and cut loose. Here again we have a kicking circuit similar to a buzzer but in addition get a fine display of fireworks. Even if it don't toe up on

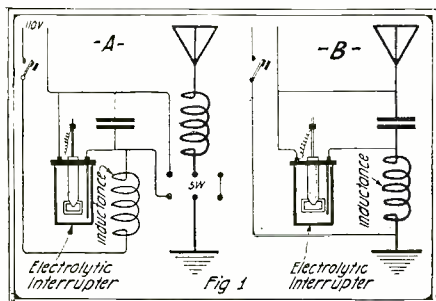

1. What Is the Matter With These Two Transmitter Circuits Which Dispense With That Spark Coil Stuff?

time and let the high powers wait awhile. From the Q.R.M. it is apparent that low powers are handy or even might be made compulsory for the larger stations while a lot of us have to be satisfied with 48 watts or so, input. Of course we could use a spark coil, or a buzzer or a modulated tube set but we want something new. What's the use of working with things everybody knows about, tell me that?

All right, for a low power transmitter why not use an electrolytic interrupter? No, none of that spark coil stuff; just an interrupter and perhaps an adjustable inductance. A buzzer set operates on the kickback obtained when a circuit containing an inductance is suddenly opened. An electrolytic interrupter will open a 110 V. circuit at an extremely high rate so by using a heavy inductance in series we ought to get a full grown and healthy kickback.

A couple of circuits are suggested in Fig. 1. At A we have a condenser in the aerial circuit shunted across the interrupter with an adjustable choke coil in series with the interrupter.

Then every time the interrupter opens up the condenser will get a charge from

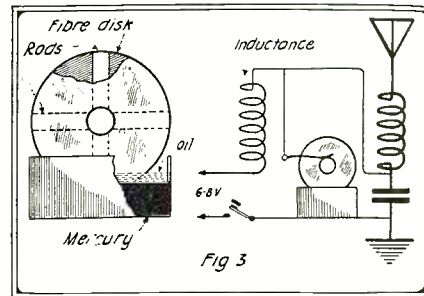

3. But, Then the Previous Two Systems May Annoy the Neighbors, so Here's a Nice Quiet Arrangement.

transmitting it's a fine thing to have hooked up when friends who know nothing about wireless drop in to see you. Of course the device can be used with storage batteries for power and ought to knock things about a bit considering the classy receiving sets that decorate every radio table.

Perhaps you would like to try something that won't annoy the neighbors so much. Well, make a little interrupter by drilling radial holes in a two inch disk of fiber and insert four rods flush as shown in Fig. 3. Mount this on a motor shaft and arrange a mercury container so the lower edge of the wheel will run in the mercury. Pour a layer of paraffin oil on the mercury and connect her up as per diagram. This is a little set that ought to do good work when tuned up right.

Say, that last rotary buzzer rather intrigues me, it ought to sell too if a fellow could get it up neat. Lets see it could be built for about \$1.50 complete with motor and sell for about—doggone it, a guy ain't got a chance to do a blamed thing anymore, just as soon as he gets a good idea to make money he's got to buy the kid a pair of shoes or sumpin and then he is broke again.

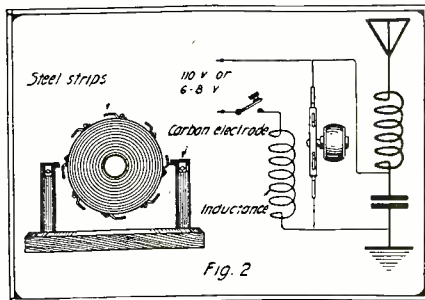

2. On the Other Hand If You Do Not Want to Use the Smelly Electrolytic, Try a Pinwheel Arc Transmitter Like the One Shown Here.

Fading Signals

A Possible Explanation for a Sometimes Very Annoying Condition Presenting Itself at Crucial Receiving Moments

By CLYDE J. FITCH

VERY frequent phenomenon which baffles radio experimenters is the inexorable fading away of signals. The signals gradually fade away and then gradually increase to their original strength. This mystic phenomenon takes place sometimes within a few seconds and then again it may last for days. At one night we can hear the distant stations loud and clear and not hear a sound from nearby stations. The next night things are reversed. The nearby stations come in loud and clear and the distant stations are inaudible. Sometimes we can't pick up a nearby station no matter how carefully we adjust our instruments or how sensitive the instruments are, yet a station located a greater distance from the sending station than we are copy this station on a bed spring aerial and crystal detector. This fickleness of signals is very pronounced, especially among the amateur stations. Even in this day of high amplifications the signals will persist in fading away.

If we only understood the cause of these

freakish conditions perhaps we could find some means to control them and make them a benefit rather than a hindrance to radio progress. Unfortunately theories have been advanced that this phenomenon is due to atmospheric conditions, refraction of waves, moving clouds, etc., making a

solution of the problem so obscure that radio experimenters prefer to leave it alone. In the following paragraphs the writer will give a simple and probable cause of this phenomenon and suggest a method of controlling it at will.

Figure 1 shows a profile of the surface of the earth and a wireless sending station, indicated at A. The sine curve represents the potential of the energy as it is conducted over the surface of the earth, that is, the energy from the sending station is radiated from the antenna, also conducted over the surface of the earth, and radiated from the surface of the earth. The energy picked up by a grounded receiving station is that component of energy which is propagated by conduction over the surface of the earth. From the curve in the illustration we see that at every half wave length there is a potential node, that is, a point of zero potential. These nodes always remain stationary, the next half oscillation merely turns the curve bottom side up. You

(Continued on page 646)

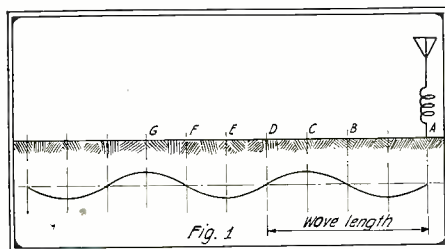

4. In This Profile of the Earth's Surface It Will Be Seen By Observing the Sine Curves That There is a Potential Node at Every Half Wavelength, a Fact Which the Writer Employs in His Explanation.



An Efficient Receiver

By FREDERICK J. RUMFORD

THIS receiver is efficient because it occupies little space, is inexpensive, being within the purchasing power of the average Amateur, and it is quickly assembled, as it contains fewer parts than the average receiving outfit. I have not calculated wave-lengths, but have received Arlington (NAA), Key West (NAR), and San Francisco (NPG).

The accompanying cut is as follows, figure No. 1 represents general layout of the front view of the panel showing wiring, dimensions and correct position of the various articles. Figure No. 2 represents side view of one of the coils, figure No. 3 shows side view of position of panel and handles on the coil movers and figure No. 4 is top view showing position of coil, and how pivot blocks and rods connect in rear of panel.

The panel has two square holes cut out large enough to accommodate coil pivot blocks, also, so that it will be able to work freely. There are two rods running vertically through the coil blocks, primary and tickler, which acts on pivots. There are also two other rods which run lengthwise (horizontally) that are connected with one corner of each block and extend out beyond side of panel. When the rod on tickler coil is pushed, it throws the coil outward; when pulled, inward. When the rod on primary coil is pulled, it throws coil outward, and when pushed, it throws the coil inward. These rods are of round fiber, $\frac{1}{4}$ " in diameter, and the Amateur is to use his own judgment as to the lengths of the rods. It will take a little experimenting on the part of the Amateur in securing the right length for the proper leverage.

The coils are of the multi-layer type with airgaps of $\frac{1}{4}$ " between layers, wound with No. 30 D.S.C. magnet wire with 67 turns to each layer. The diameter of the form upon which the coil is wound is $3\frac{3}{4}$ " outside and the first layer is wound upon the form itself, the second layer being separated from the first layer by cardboard strips $\frac{1}{4}$ " thick, one inch long (eight of these strips being used to a layer, spaced equally apart around the form) and so on through the various layers. After the first layer is wound start all others back where you started the first and have

them all wound in the same direction.

The first layer takes $10\frac{1}{4}$ " of wire to a turn or a total of 58' of wire to the layer; the second layer has 12" of wire to a turn or a total of 67' of wire to the layer; the third layer has $13\frac{1}{4}$ " of wire to the turn or a total of 74' of wire to the layer; the fourth layer has 16" of wire to a turn or a total of 90' of wire to the layer; the fifth layer has 17" of wire to a turn or a total of 95' of wire to the layer; the sixth layer has 18" of wire to a turn or a total of 101' of wire to the layer.

There are three coils in all, and each one is made alike. Each coil contains in all 485 feet of wire, or a total of 1,455' feet of wire for the three of them, which is just exactly $\frac{1}{2}$ lb. of wire, but it is advisable for the Amateur to purchase $\frac{3}{4}$ of a lb. of wire.

It is not advisable to shellac the coils because this creates energy losses as it acts as an imperfect dielectric between the turns. However, if the Amateur wishes to shellac the coils, he should shake them dry, leaving only a thin film or layer of shellac on the coils. Each coil should be covered with a fiber band drawn tight, to which the different blocks are attached.

Have the block that fastens on the primary and tickler coils extend out on back of panel three or four inches so as to allow clearance for binding posts, switches, wiring, etc., this block to work on pivot as per drawing.

The spacing of the potentiometer and rheostat depends upon the model used. The Amateur may have to change the spacing of the binding posts on the multi-layer coils as it depends on the size binding posts

up longer.

A few words regarding the panel itself. The material can be either Bakelite, rubber or oak; oak is preferable, however, as it is within the purchasing means of the average Amateur. The writer has used oak for the panel on this outfit.

Care should be taken that all coils are wound in the same direction, L1 the primary, L2 the secondary, and L3 the tickler. It is advisable to shunt the primary, secondary and tickler coils with a variable condenser so that the wave lengths of either circuits can be varied; the primary L1 and secondary L2 condensers have a maximum capacitance of 0.001 mfd., but the maximum capacitance of tickler coil L3 condenser should not exceed 0.0005 mfd. It is also advisable to shunt across the terminals of the B battery either a variable or fixt condenser with a value of 0.005 mfd.

The purpose of the filament control switch is to burn either filament at will. With this outfit the writer uses a genuine double filament Audiotron tube. The B battery consists of 10 or 12 No. 703 Eveready flashlight batteries wired in series.

The illustration is self-explanatory and if followed closely will enable the Amateur to build up this outfit correctly.

THE LATEST WORD IN INDUCTANCES

Watch for the June issue of RAN which will contain some first hand information on the new Duo-lateral wound coils.

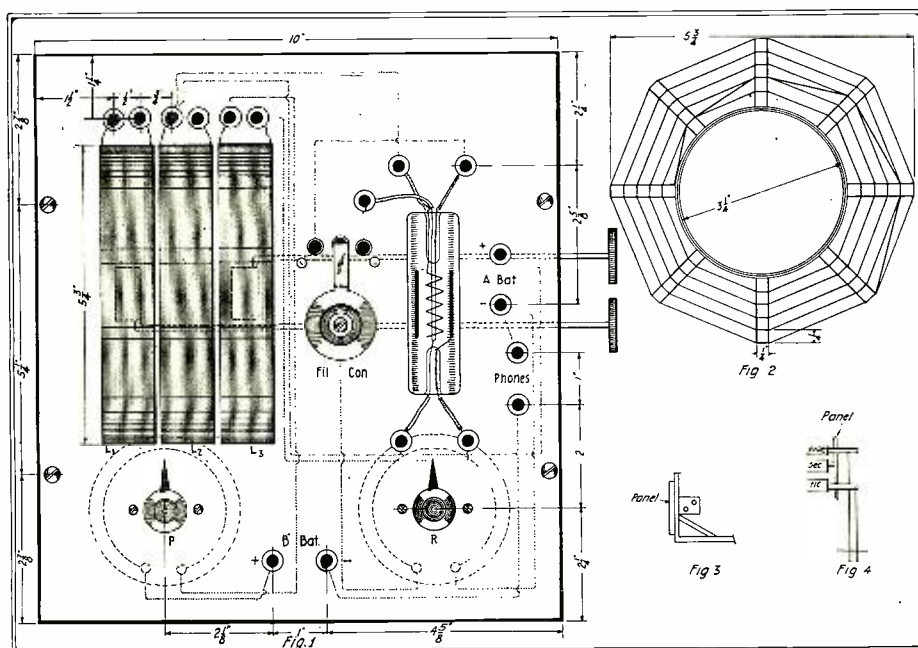

In This Assembly, Fig. 1 Shows the General Lay-out of the Front View of the Panel; Fig. 2 Represents the Side View of One of the Coils; Fig. 3 Shows a Side View of Panel Position and Coil-mover Handles; While Fig. 4 Is the Top View Showing Position of the Three Coils As Well As Adjusting Rods.

employed with set.

The potentiometer and rheostat should be of the type that is mounted on the back of panel. The potentiometer has a resistance of 400 ohms, the rheostat has a resistance of from 10 to 15 ohms.

A word to the wise on mounting the rheostat: Be sure and mount your Audiotron tube, binding posts, etc., all wired first; otherwise you will find it a hard task doing it after the rheostat is mounted. The rheostat and potentiometer should be mounted so that they do not rest on the back of the panel. There should be $\frac{1}{2}$ " space between the panel and the above.

It is advisable to use rigid wiring on the back of the panel. It will stand

A Short Cut in "Bank Winding"

By WILLARD H. FARR

The recently developed "banked" form of winding for wireless tuning coils has many features which recommend it for amateur use. One of these is that it eliminates the unwieldy and wasteful loading coil, as it makes possible the winding of a tuning coil of very moderate dimensions having sufficient inductance to tune all the long wave transatlantic stations. An other feature is that it reduces the distributed capacity effect which would be present if the same amount of wire were wound on a coil with a single layer, thus approaching the results obtained with the honeycomb type of coil. Many amateurs, however, who would like to use this form of winding are discouraged from doing so by the large amount of time and patience which it requires.

In winding a long wave tuning coil a short time ago, I devised a short cut which makes it almost as easy to wind a coil with banked turns as one with a single layer of winding. This stunt proved so successful that I am passing it on for the benefit of other amateurs.

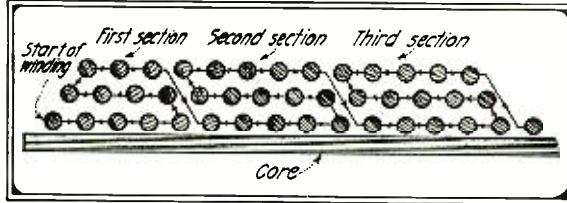

This Diagram Shows An Imaginary Cross Section of One Side of a Coil Having Three Layers and at the Same Time Gives You an Idea Just How to Go About the Winding Process.

My suggestion is, instead of banking single turns, to wind small sections, say ten turns wide, each of which is banked. For example, the system of winding a three layer coil would be as follows: (1) Wind ten turns on the core. (2) Wind a second layer back over this. (3) Wind a third layer over the second. (4) Bring the wire back to the core and repeat the process. The accompanying diagram is an imaginary cross section of one side of a coil with three layers, showing how to start the winding. Each circle represents one turn, the lines between the circles indicating the

order in which the turns are wound. For the sake of simplicity only five turns are shown in each section.

Some of the specific advantages of this system of winding are the following: There is very little trouble from the turns "falling" while winding. As a number of turns are wound without stopping, this system is much faster than the "single turn" system, and is better adapted for winding in a lathe.

The finished winding is very smooth, and if all the cross overs are made on the back or bottom side, the coil will look exactly like one wound with a single layer. In a coil wound as described above, the distributed capacity is practically the same as if every turn were banked, making it well suited for receiving undamped signals.

With my tuning coil wound as described above, having a primary ten inches long by four inches in diameter, and a secondary ten inches long by three and one-half inches in diameter, with three layers on each, I have copied Sayville, New Brunswick, and Annapolis, and could tune to still higher wave lengths.

"B" Battery Improvement

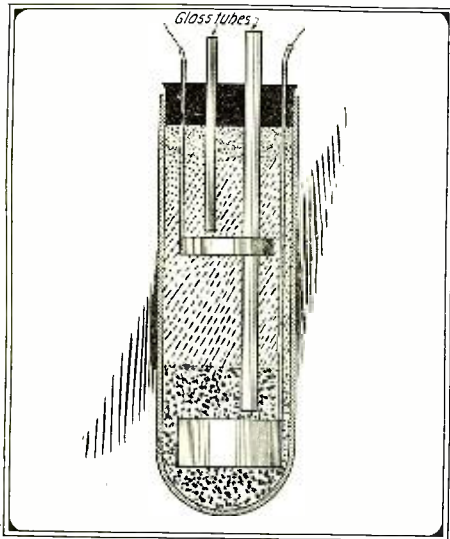

When Your Homemade Dry Batteries are Exhausted, Simply Pour a New Solution Into the New Tubes and Thereby Tripple Their Operating Life.

In home made dry "B" batteries made from test tubes, jars, etc., the battery is usually assembled and sealed and in order to renew them it is necessary to take each one entirely apart, which is quite a job, when you have 40 or 50 of them. I used the following plan and found it very satisfactory: When assembling, as shown in the diagram, put in two small glass tubes which are sealed by small corks and then the tops of the tubes dipped in paraffin. Then to renew the battery, remove the corks and pour the solution down the tubes.

Contributed by ROBERT C. BRYANT.

PRACTICAL METHOD OF MAKING VARIABLE CONDENSER PLATES.

Recently the writer was called upon to repair a variable condenser of the rotary

type and found that there were no spare plates in stock but there was, however, plenty of sheet aluminum.

Knowing from experience what a hard task it is to cut out plates with tin snips or shears without having them buckle, and furthermore needing a large number for the job on hand, the following method was decided upon and proved to be very satisfactory:

One of the old plates was used for a model and the outline traced on a block of hard wood about one-half inch thick. Two such blocks were clipt together and the form was cut out on a hand saw. The sheet aluminum was cut into square sheets large enough so that when the wood block was laid on top of one of the sheets, the sheet extended slightly beyond all edges of the wooden form. The metal sheets were stacked together with one wooden form on the top and the other on the bottom and then clamped. The necessary holes were then drilled on the lugs thru wood and all. Stove bolts of sufficient length were past thru the holes and the nuts fastened down as hard as possible. The plates were then taken to the power grinder and the metal ground off until it was flush with the edge of the wooden pattern. The plates were then removed from the form and the edges

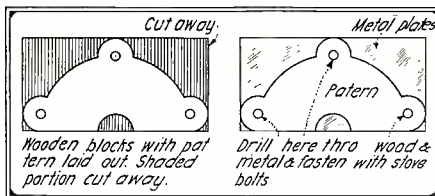

Any Experimenter Having Access to a Power Grinder May Easily Construct His Own Condenser Plates.

finisht off with an oil stone to remove the burrs.

Contributed by JESSE J. HIPPLE, C.M.M., U.S.N.

Efficient Loading Coil

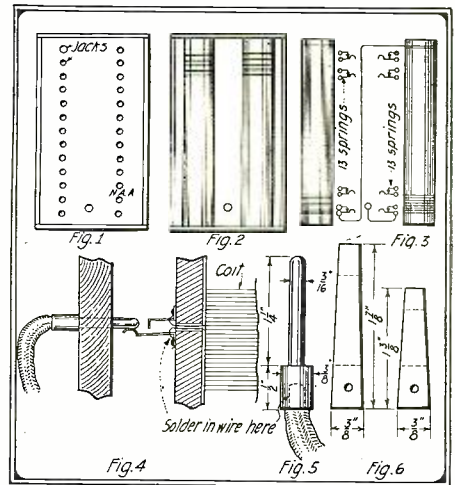

If You Are Looking for an Efficient Loading Coil, Doing Away With "Dead" Ends, Follow Out These Directions.

This jack and plug type of loading coil is designed to do away with complicated dead end switches and consequent capacity effects. It is also made to resemble the popular cabinet panels. The cabinet and number of coils can be made any size to suit the amateur. The call letters of the different stations may be printed or painted under the corresponding jack. It will be noticed that if the springs are properly made and adjusted, they have a slight contact cleaning effect when used with plug, insuring good contact. All wires must of course be soldered. Another good point is that when the plug is inserted in bottom jack, coil is cut out of the circuit entirely.

The following gives a general idea how to make the device. First a hardwood panel must be secured to bore the holes for plug. Any hardwood that will make a clean cut

(Continued on page 661)

A Closed Core Magnetic Rectifier

By J. STANLEY BROWN

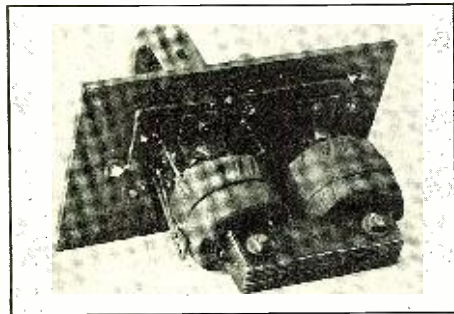

Photographic View of the Transformer Side of This Effective Magnetic Rectifier.

WE Radio Experimenters sometimes find it a great deal of trouble to keep our storage batteries charged, even if we happen to know a battery man who is perfectly honest. We might as well admit that one of our greatest desires is for a little device that may be plugged into a 110 V. 60 Cycle source of supply and deliver direct current of proper voltage at the other end. With all due apologies to existing types, the writer will describe in the following columns a closed core magnetic rectifier.

This rectifier, which occupies a space 6" x 9", is only 9 1/2" high. It weighs but 10 pounds and is easily carried from place to place by making use of the magnet as a handle. The extreme simplicity of the device may be noted by glancing at the illustrations and the accompanying drawings. The wiring diagram may be seen in Fig. 1. The device consists of a core, a primary winding, two secondary windings, a mounting panel, a permanent magnet and a steel

The operation is briefly as follows: The current in the primary magnetizes the core and the armature as well, as it is made fast to an extension of the core. Due to the fact that the armature is between the pole pieces of a permanent magnet, it is attracted to one pole piece and repelled by the other and vice versa for each change of flux direction in the core. It will be seen from the above that the armature swings in synchronism with the current source. Taking advantage of this fact, all that we have to do is arrange a series of contacts so that for each reversal of current one secondary may be thrown out of the circuit and the other in. Now if these two secondaries are connected to a neutral point, such as is afforded by the switch and resulting

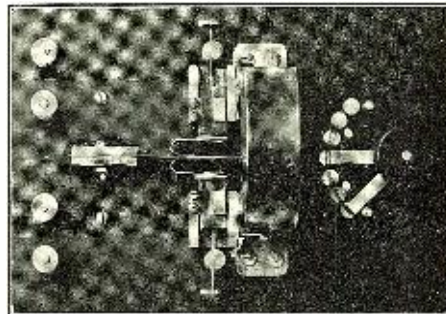

Front View of the Operating Side of the Complete Instrument. What do You Think of It, Boys?

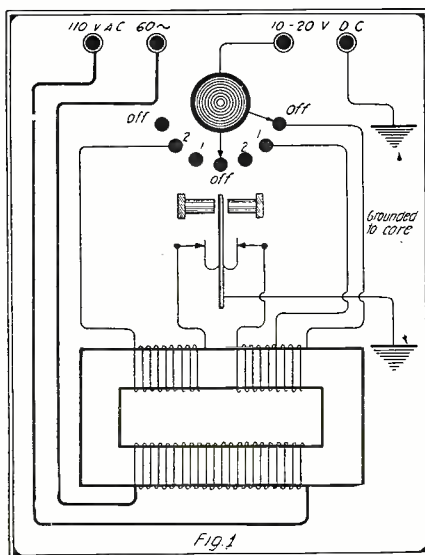

This Is a Complete Wiring Diagram of the Rectifier. A Tap was Omitted From Point 1 to the Center of Secondary on Left of Transformer. This Should Be Included.

is flowing in either secondary because the vibrator is changing contact. If it were not for the springs on the contacts the rectification factor would be much lower. These springs cause the time of contact to be prolonged and, therefore, minimize the period of idleness directly following the break. To illustrate the gain by using a full wave rectifier the fourth curve is drawn. It is the curve of a half wave rectifier and shows a rectification constant of about .45 when 1 is taken as 100% rectification.

The attention of those desiring to construct this useful device is called to Fig. 3, which gives the dimensions of the core and the projecting lug. Make this core of silicon steel or transformer iron about .016" in thickness. It should stack 60 thicknesses to an inch. Mount the core to the panel by means of brass brackets as shown in the photograph.

As the primary current is continuous and does not vary more than 50% as the secondaries make and break it is well to rate it at 1,000 circular mils per ampere. Basing

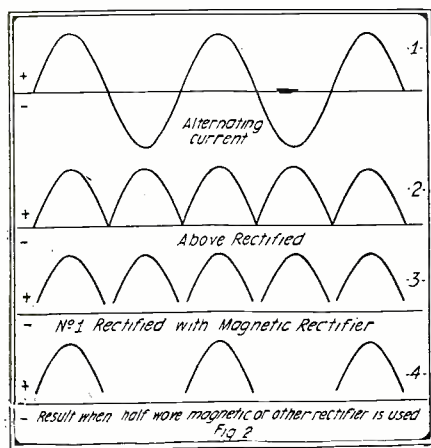

These Four Curves Represent the Functions Thru Which the Alternating Current Passes From the Time It Enters the Primary Until It Is Finally Rectified Into D. C.

reed carrying two contacts. The contacts just mentioned are mounted on steel springs for reasons to be stated later. According to the load this rectifier draws from 100 to 200 watts from the line and will charge a 12 volt battery at as high a rate as 12 amperes without overheating. It is safe to go away and leave it over night and it will be buzzing merrily along in the morning. The contacts should be adjusted after each run of considerable duration. A six volt sixty ampere hour battery may be charged at a current cost of less than ten cents.

binding post, in such a manner as to keep current flowing in the same direction thru it, regardless of which coil is part of the circuit, we will obtain the desired result. Take note of the direction of winding as shown in the wiring diagram. Actually it would not be necessary to use a secondary if we did not wish to step our current down to voltage suitable for charging purposes. Referring to Fig. 2 at the top, we see the typical sine wave of alternating current such as enters our primary. Next we see the wave form of this same current when it is rectified with a theoretical efficiency of 100%. Below this the resulting unidirectional pulses of this rectifier are to be seen. The rectification factor is about .8 or .9 due to the period when no current

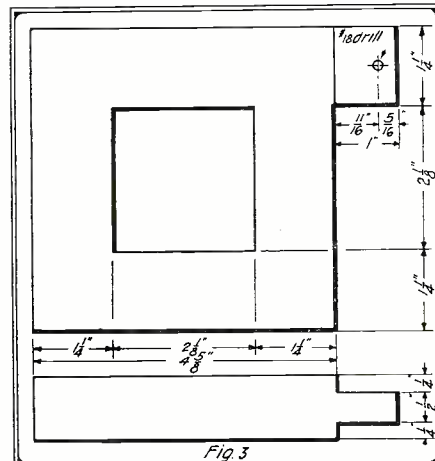

In This Sketch We Have the Dimensions of the Core Laminations With Projecting Lug. These Should Preferably Be of Silicon Steel.

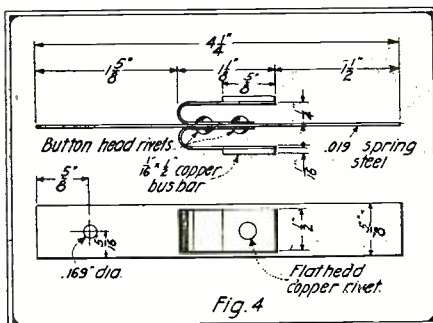

In Building the Armature Follow These Dimensions Explicitly, Otherwise the Writer Will Not Vouch for Successful Operation.

our wire size on the assumption that 1.3 amps, is the average maximum current to be expected, we will require No. 19 B&S D.C.C. copper wire for this winding, 550 turns being required. The primary should be wound on a split form and taped as shown in the picture before slipping over the core. The terminals should be run thru "Empire Cloth" tubing to the binding posts.

As neither secondaries form part of a circuit more than 45% of the time, it is well to rate them rather slow. They should be wound from No. 14 B&S D.C.C. wire

(Continued on page 651)

Combined Audio and Radio Frequency Amplification

By PALMER H. CRAIG

MUCH is said nowadays concerning the amplification of audio frequencies, but very little is heard about the amplification of radio frequencies, altho it is a well known fact among experts that the addition of a single stage audio frequency amplifier to a regenerative circuit is practically of no use in increasing signal strength, whereas the addition of a single stage radio frequency amplifier to such a circuit results in considerable increase in signal strength. Realizing that the average amateur experimenter cannot afford to purchase 3 or 4 bulbs and their accessories to make an amplifier to such a circuit results in experimenting for some time on a receiver-amplifier using only one bulb in the entire circuit. Experiments have proved that the circuit described herewith will amplify incoming signals as greatly if not more than the ordinary audion circuit plus a two stage audio frequency amplifier which employs three bulbs. Using a constant impedance audibility meter, total signal amplification of 103 was recorded with this circuit over the ordinary audion non-regenerative hook-up.

Figure 1 gives the complete circuit which was used in the final experiments with this system. Referring to the diagram, it will be seen that pancake coils, known by the trade names of "Honeycomb" and "Universal wound" coils, are employed for the receiving transformer. The primary and secondary coils are shunted by the variable condensers PC and SC respectively, which are each of .001 mfd. capacity.

T is an audio frequency amplifying transformer such as is manufactured by several radio companies, and should have an impedance ratio of approximately 12 to 1. Such a transformer can be made as follows: Wind 4,000 turns of wire over an iron core 1/2" in diameter and 3" long, and

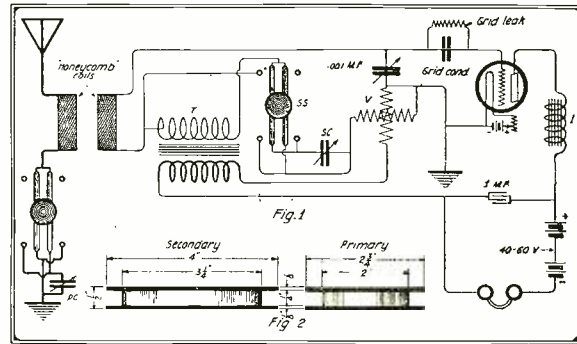

Fig. 1 of This Diagram Shows the Complete Circuit Used By the Author While In Fig. 2 Is Shown the Form Dimensions of the Radio Frequency Transformer-Variometer.

over this primary wind 15,000 turns of wire. No. 40 enameled wire is used for both primary and secondary. The primary should be well insulated from the core and from the secondary by several thicknesses of empire cloth, and the whole boiled in paraffin to insure complete insulation.

V is the radio frequency transformer made in the form of a variometer. It is made as follows: On a wood turning lathe turn out 2 wooden pies of the size given in Figure 2, and wind each with No. 40 enameled wire. One-fourth pound should be wound on the primary and 3/4 lb. on the secondary. The completed pies are then mounted on a shaft and scale and pointer attached. The primary (the smaller coil) is so arranged that it may be revolved within the secondary.

The variable condenser SC is of .001 mfd. capacity, and is arranged by means of switch SS so that it may be switched from series to shunt with the secondary winding of the audio frequency transformer T. The closed oscillatory circuit is tuned to resonance with the plate circuit by means of this condenser.

The phones and "B" battery are shunted by a 1 mfd. condenser which may be fixt. Little change is noted if this condenser is as large as 2 mfd.

I is the plate series inductance of the iron core type. In his experiments the writer has tried several different kinds of inductances here, including the open core variable type, the pancake wound continuously variable type, and the closed and open core fixt types. The open iron core fixt type proved to be the most efficient from the comparative results of these experiments. In actual use the writer found that the secondary of a 1/2" spark coil could be used with excellent results without taking the coil apart.

The grid condenser and grid leak are of the standard forms now in use; the former being of exactly .0006 mfd. capacity and the latter of 2 megohms resistance. The grid condenser may be made by clamping two copper plates in a fixt position, being separated by a fiber or bakelite strip exactly 1/4" in thickness.

The operation of the circuit is somewhat as follows: The pancake inductances are set close together, V is completely thrown in, all variable condensers are thrown in completely with the exception of SC, which is set at about 90°. The filament is brightly lighted and the "B" battery current is switched on not by steps but all at once. This last must be done in order to get the circuit to oscillate. Should the bulb cease to function properly it may usually be put in order again by simply switching off the "B" battery and switching it on again rapidly. In receiving some stations it was found that increased signal strength was noticed when one end of the filament was grounded as shown in the diagram. Careful manipulation of this system will result in marvelously loud and distinct signals.

"A Binder for Your R. A. N."

By FRANK E. PETERSON

Fellow readers of RADIO AMATEUR NEWS, why not keep your numbers of this fine magazine in a binder? Then you will always know where they are, and they will always be together so that looking up any article will be but the work of a few seconds.

To construct a binder like the one I made, is but the work of a few minutes. From a piece of extra heavy cardboard cut two pieces each 13 inches long and 9 inches wide, and two strips 13 inches long and 1 inch wide. The two large pieces should be covered with medium heavy cloth. Next go to the Job Printing shop, or the Stationery store, and get about 5 feet of black binding cloth, that which I used was about three inches wide. Lay one strip and one of the covered pieces on a table leaving a distance of about 3/8 of an inch between the two. Cut and moisten a 14-inch strip of the binding cloth, and fasten the two pieces of cardboard together with it, taking care to allow half an inch on each end and on the one side for turning under. On the other side put another piece of binding cloth, this strip must not lap over but instead it should be just a fraction of an inch smaller on

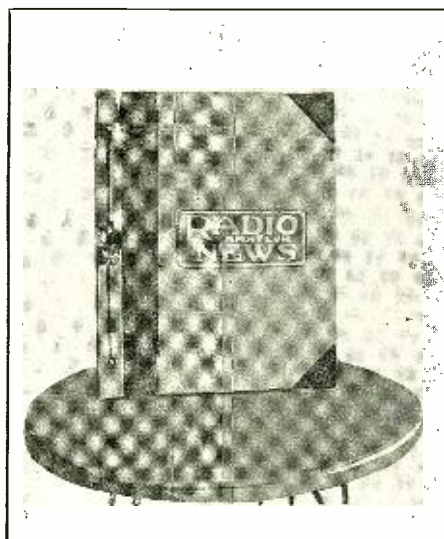

Follow Mr. Peterson's Advice and Preserve Your Magazine Copies in This Fashion. Be Efficient!

the three sides. Cover the two remaining corners with binding cloth to protect them from wear. The other two pieces of cardboard are put together in the same manner. Three holes are punched in each of the binders and in the magazines, and all are laced together with a heavy shoestring.

When a new copy arrives, just punch three holes in it and lace it in with the rest.

READ THIS!

If gummed paper tape, such as is used by merchants to do up packages with, is applied to the hinge edge of all magazines when they are received, the magazine will be strengthened and be better able to resist the wear and tear imposed on it in the shop. Readers of RADIO AMATEUR NEWS can do well to do this to their magazines, because if the cover is saved, so is the rest of the magazine.

A very small camel's hair brush is a handy thing to have about the operating table, for with its aid, the dust and filings which invariably collect in between the contact points of a panel can be easily removed.

Contributed by ALBERT B. FULLER.

Construction of a Mounting for Home-made Honeycomb Coils

By WINTON G. GEORGE

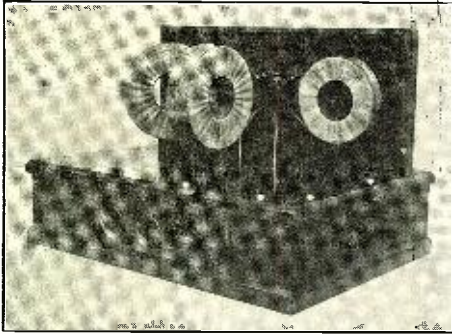

Oblique View of the Honeycomb Coil Mounting Described Here. Nice, Eh?

A DESCRIPTIVE outline of the construction of the coil-mounting shown in the accompanying photographs was written with a view toward its being of possible interest to those amateurs who have more or less time at their disposal for building their own instruments. Simply moving the coils about on the table will give exactly the same results; but there are many "bugs" who like a finished-looking piece of apparatus, and when it is complete they generally do not begrudge the extra time spent in its construction.

A glance at the illustration will give an idea of the operation of this particular instrument; the coupling between the coils being varied by means of the knobs mounted on the front of the cabinet.

The coils used in this instrument were built following the directions given by Mr. C. R. Dunn in the December number of this publication, and for those who followed these same directions in winding their coils the dimensions given herewith will probably be right. In any case, however, they may be taken as merely suggestive and made to conform with the individual case.

It will probably be found convenient to start by forming the brackets which support the coils. These were constructed of copper bar, one-eighth of an inch in thickness and five-eighths of an inch wide. Brass will serve the purpose just as well, altho somewhat more difficult to work. Further dimensions may be had by referring to the diagram of Fig. 1. (Three-sixteenths inch brass rod was used thruout and will probably be found most satisfactory; it will, of course, be necessary to decide upon the size to be used before working on the brackets or blocks.) A three-sixteenth inch hole is sunk into the under side of the extending arm of the bracket, just deep enough to form a socket for the end of the brass rod; care should be taken not to bore in far enough to "start" the opposite surface. After boring this hole, take a short piece of brass rod, the end of which has been slightly rounded, and place in a bit-brace and use it as a reamer; this will smooth out any rough spots left by the drill and will form a socket in which the rod will turn easily. After drilling two holes through the back of the bracket, through which round-head brass screws pass, fastening it to the panel, the bracket may be finished by filing smooth the corners and edges.

The brackets shown in Fig. 1 are used to support the two outside coils, *i. e.*, the primary and tickler. The secondary coil is supported by a bracket such as is shown in Fig. 2; holes are

drilled through the top and bottom arms of this bracket, through which round-head brass screws pass into the wooden block to which the coil is fastened. In passing it might be said that soft pine is very satisfactory for making these blocks, in that it is not so apt to split as other woods.

Fig. 3 shows a side and front view of the block on which the center or secondary coil is mounted. It will be best to cut out this block so that the grain runs the short way; *i. e.*, it should be one and one-quarter inches long by one and one-half inches wide. If the grain ran the long way the screws would not hold so well and the weight of the coil would have a tendency to split the block apart. In cutting out these blocks use a fine-tooth saw, so that the edges will be smooth and even; a coarse saw chips out the grain and makes a rough-looking piece of work. "Bumper" blocks should be cut from strips one-quarter of an inch square, and their inside corners should be rounded, as shown in Fig. 3. Make certain that these corners are perfectly smooth and sufficiently

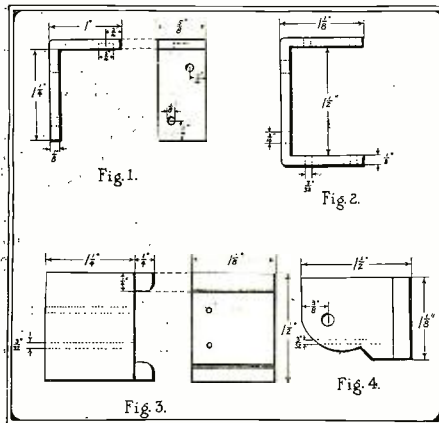

These Four Figures Represent Construction Details of the Various Necessary Parts.

rounded, so that they will not cut into the coil when the latter is mounted. After properly shaping these strips glue them to the upper and lower edges of the block, as shown in the diagram (Fig. 3), using a good grade of glue. Next drill two small holes through the block, from front to back, parallel to each other and perhaps a quarter of an inch from the edge. Through these holes pass the wire leads from the coil; the drill used should not be larger than three-thirty-seconds of an inch.

Fig. 4 shows a top view of the mounting-block to be used for the primary coil. The side and rear corner should be shaped somewhat as shown, so that when the coil

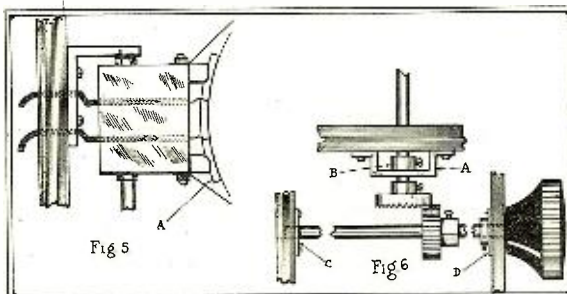

In These Two Diagrams We Have the Mechanism Which Varies Two of the Coils. By Following the Instruction of the Author Anyone Can Secure Similar Results.

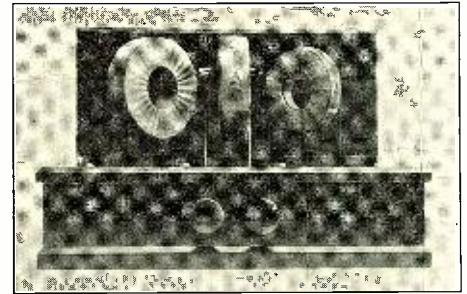

This Is Certainly a Good Looking Instrument. We Congratulate Mr. George on His Construction Ability.

is rotated the block will clear the bracket and the screw-heads. Of course, the bracket arms might be made long enough in the first place so that cutting the blocks in this way would be unnecessary; but it is wise on the other hand to have them short in order to bring the weight of the coil as near the panel as possible. In the center of this block, three-eighths of an inch from the rear edge, a three-sixteenth inch hole should be drilled, through which the brass rod will pass. Care must be taken to bore this hole absolutely squarely; otherwise the coil will not rest squarely on the rod and will be out of alignment with the secondary.

Great care should also be taken in drilling the holes for the wires in this particular block. If they are not drilled squarely there will be danger of their breaking through the side or running into the rod hole. With a little patience, however, this can be done without any trouble; it being always a good idea to drill slowly.

The tickler coil block is cut out in the same manner, with the exception that it is narrower than either primary or secondary coil block; being in this particular case three-quarters of an inch in width. By sufficiently rounding the rear right-hand corner of this block it will be found unnecessary to cut off a section of the side, as was necessary in the case of the primary coil block. If the diameter of the tickler is the same as that of the primary and secondary, the block will of course be the same length; however, as will be seen in the illustration, this tickler had fewer layers of wire, which necessitated cutting the mounting-block a little longer, so that the tickler and secondary would be concentric when brought together. Also, due to the fact that the tickler is narrower than the primary, the distance between tickler and secondary brackets must be less than that between primary and secondary brackets. Various details of this kind, however, may be left to the individual constructor, and any changes made as desired.

After completing the blocks it will be wise to stain and varnish them with the desired finish, as this would be rather difficult after the coils are mounted. When dry, they will be ready for mounting the coils.

The supporting bands used by the writer were made from heavy gray insulating paper; heavy wrapping paper is not tough enough. This detail, however, may be left to the reader. Diamond-shaped openings are cut as desired, care being taken to leave at least two inches between the end of the paper and the first opening. An idea of the method of mounting may be had

(Continued on page 653)

\$100 "PORTABLE RADIO" PRIZE CONTEST

WE are pleased to announce a third \$100 prize contest entitled "**Smallest Portable Radio Outfit**". Our Radiophone contest just having closed successfully, we believe that our readers would be interested in the new contest, of which we have the following to say:

A great many amateurs,—if not the majority,—are intensely interested in a small portable outfit that can be taken about when visiting friends, when going away for week-end parties, for camping and a great many other purposes. Particularly during the summer and fall a good portable receiving outfit is greatly desired and highly prized, as we have been able to satisfy ourselves from experience.

With modern radio apparatus, properly put together, it is possible to receive messages over surprising distances, even with small, but compactly built, apparatus, and there is no reason why our amateurs should not be able to turn out something really worth while. In awarding prizes the judges will take into consideration *not only the smallness of the outfit, but its efficiency as well*. In other words, the first prize will not necessarily go to the amateur who builds the smallest outfit, but rather to the one who builds a small one that is efficient as well. Of course the word "small" as used here is rather elastic. In other words, the outfit which can be slipped into the pocket might be a small one and yet there might be a smaller one, no larger than an ordinary watch! But, bear in mind, what we are after is not a freak outfit. A microscopic radio receiving outfit could no doubt be built, but we daresay, it would not be very efficient. We have recently seen a European outfit that was quite complete and could be carried around in a walking cane, and this was not a bad idea at all; besides it worked well. This may be a hint for some of our radio enthusiasts.

Requirements of the Outfit

THE outfit must have means for tuning. It may have one or more detectors. It should have means for receiving

messages by sound, which may be the usual set of telephone receivers *or something better*.

An instrument, for instance, that amplifies the sound without using the regulation telephone receivers. This is perfectly possible today. (See page 16 July issue R. A. N.) Vacuum tubes or detectors or both may be used. There must, of course, be also an aerial of some sort as well as a "ground" or ground connection. Due to the very nature of the contest, it is of course necessary that the aerial be such that it will not take up too much room nominally. Concentrated aerials of the loop type can be used, or any other contrivance that takes up a minimum space, but gives quite a good capacity when unfolded or extended.

Remember that the editors are not looking for freaks. *The outfit must work* and in order to prove it, the contestant must build it, for no entry will be considered, unless it is accompanied by a photograph of the actual outfit. The judges also reserve themselves the right to inspect

one of the judges will pass upon the manuscripts submitted, and there can be little doubt that all contestants will be treated fairly and impartially. From the very nature of the contest, we are certain that it will not only bring out the very best there is in the American amateur, but that it will advance the art for portable radio receiving outfits considerably.

Rules for the Prize Contest

THE set to be described may be of the usual receiving type. Vacuum type, electrolytic or crystal detectors may be used at the option of the builder. There should be some new features embodied in the outfit that are not known now, or have not been published heretofore. It is quite important, and as a matter of fact necessary that the set must have been actually built, that it is either in use, or has been in use. "Ideas" or patent descriptions are strictly excluded from this contest. It is also obvious that insofar as this contest is conducted chiefly to bring out NEW ideas, commercial radio outfits are excluded from this contest. It is necessary to state what instruments are used, and if some of the instruments have been bought, the make must be stated. A good diagram of the connections neatly executed in ink is to be furnished. A good photograph, not smaller than 5x7 inches giving at least two views of the set is necessary. A photograph of the builder is also required.

More than one outfit may be entered by contestants. The contest is open to everyone, radio clubs included, except manufacturers of wireless apparatus. The manuscripts should not be longer than 1500 words; 1000 words preferred. All prizes will be paid upon publication.

The Contest closes in New York July 12th, and the first prize winning article will appear in the August, 1920, issue. Address all manuscripts, photos, etc., to "Editor Portable Radio Prize Contest," care of this publication.

PRIZES OF \$100 IN GOLD	
First Prize	\$50.00
Second Prize	25.00
Third Prize	15.00
Fourth Prize	10.00

and test the outfit if this should be deemed necessary.

In publishing the various ideas, all the rights revert to the publishers. The latter also reserve themselves the right to publish manuscripts which were sent in to this contest, altho they are not prize winning articles. In that case full space rates will be paid for any manuscript published that did not win a prize.

As will be noted, the publishers offer prizes totaling \$100.00 in gold for the best article on the *smallest practical and efficient radio telegraph or telephone receiving outfit*.

Several radio experts will act as judges in this contest. Every

RADIO DIGEST

RECIPROCAL OR "REVERSIBLE" AMPLIFIERS.

Recently, the Société Française des Electriciens held a conference in Paris, France, to decide upon the various uses of amplifiers as well as the individual construction best adapted to each when utilized to amplify telephone line circuits (wire telephony).

In previous studies it was realized that the vacuum tube in such apparatus essentially necessitate the uses of an input transformer to receive the current to be amplified and an output transformer to furnish the amplified current. It is immediately taken into account that this apparatus, having an input and an output can only transmit telephonic currents in one direction. Therefore, if it is desired to install a system of this type on a straight telephone circuit it is obviously necessary that telephonic transmitters be effective in both transmission and general amplification. In other words, it is necessary that the functioning of the apparatus as expressed in the French language, being reciprocal or reversible.

Altho apparatus of this nature is still in the laboratory stage, there exists at the present day experimental arrangements which have already been exploited in France as well as in other foreign countries, and which performs this feat quite effectively.—*Abstracted from Revue Générale de L'Electricité.*

EARLY DEVELOPMENT OF NAVAL AIRCRAFT RADIO.

By T. JOHNSON, JR.

The first operation of radio equipment on a seaplane was conducted by the Navy Department on July 26, 1912, at the Naval Academy at Annapolis, Maryland. Ensign (now Lieutenant-Commander) Charles H. Maddox, U.S.N., acting as operator on the seaplane, transmitted a message from a height of 300 feet (91.5 meters) to the torpedo boat U. S. S. *Stringham*. The communication was maintained at that time up to a distance of three nautical miles (5.55 kilometers). The complete receiving apparatus was suspended in front of the operator by a strap passing over his shoulders as shown in Figure 1. A specially constructed helmet was used for holding the telephone receivers and keeping out external noises. A "balanced antenna" with similar portions in the upper and lower planes was employed.

Early in 1916 Lieutenant-Commander (now Commander) S. C. Hooper, U.S.N., of the Radio Division, Bureau of Steam Engineering, Navy Department, realizing the growing importance of the application of radio to aircraft, urged the establishment of a laboratory for this work. Such a laboratory was started at the United States Naval Air Station, Pensacola, Florida.—*Abstracted from Proceedings of Institute of Radio Engineers for February.*

LONG DISTANCE RADIO COMMUNICATION IN CHILE.

By E. W. FIELDING.

The high power stations of Llanquihue and Punta Arenas are practically identical, each station being provided with 100-kilowatt and 5-kilowatt Marconi apparatus. The following brief description will give a general idea of the equipment:

Both stations are fitted with a 200 horsepower, three-cylinder Diesel engine running at 200 revolutions per minute, and coupled to a 250-volt, 600-ampere dynamo. A 170-brake horsepower, 220-volt motor runs in conjunction with a 100-kilowatt, 220-volt, 200-cycle alternator running at 1,500 revolu-

tions per minute, and this in turn is coupled to a 16-stud rotary disc set, thus producing a spark frequency of 400 per second. The battery consists of 122 accumulators; capacity approximately 2,000 ampere-hours.

The 100-kilowatt set is arranged to give wave lengths between 2,400 and 5,000 meters, while the 5-kilowatt set ranges between 600 and 1,600 meters. All the antenna insulators are of porcelain, the leading-in ones containing oil. The earth wires are disposed in the form of two semi-circles; the radius for the circle being 200 feet (61 m.).

There are four antennas.

Antenna A consists of 20 wires, 2,000 feet (610 m.) long.

Antenna B consists of 12 wires, 1,475 feet (450 m.) long.

Receiving antenna has two wires, 1,800 feet (549 m.) long, and the 5-kilowatt set has the usual four-wire antenna.

These antennas are arranged between seven sectional steel masts, each 253 feet (77 m.) high; A, B, and receiving antennas being in the form of inverted L's, directive to Punta Arenas, and vice versa. Measuring the fundamental wave length of the two-wire receiving antenna by an atmospheric spark direct to earth, during a storm, gave a result of 2,650 meters.—*Abstracted from Proceedings of I. R. E.*

New Radio Patents Page

The Publishers regret being obliged to omit the regular Radio Patents page this month. Up to time of going to press no patents were received from the Patent Office at Washington, information having reached us that none have been printed recently. We shall, however, endeavor to resume the page with the June issue.—The Publishers.

TELEPHONING FROM THE AIR.

By ROY J. HEFFNER

The radio telegraph was first applied to airplanes, but telegraph operators were human and made errors in code at times when errors could least be afforded. Mainly through the efforts of Colonel C. C. Culver, of the Air Service, army officials were finally persuaded to consider the possibilities of the telephone.

An interesting phase of the work was the construction of suitable antennas. No ground connections being possible, the radiating circuit must comprise both antenna and counterpoise systems. Among the many types tried were fixed parallel wires on top surface of upper wings and bottom surface of lower wings; fixed wires strung between points on the wings and tail; single trailing wires, unweighted, of various lengths; single trailing wires, weighted, with reels for winding and unwinding; double trailing wires, both weighted and unweighted, and closed loops in various positions.

Short fixed antennas were not good radiators; furthermore, loops were too marked in their directional effects. In this latter respect trailing antennas also gave some trouble. It was generally observed that ground stations ahead of the airplane received better signals than those on the sides, in the rear, or directly underneath. Double trailing antennas gave as good results as single trailing antennas of much greater length, hence their fairly general adoption.

Very good results were attained by the writer while on duty at Rockwell Field, San

Diego, in communicating from his desk telephone through the private exchange switchboard and a radio instrument, to an airplane in flight. There are many reasons why the radio telephone can probably become a competitor of the wire telephone; the mutual interests of the two will be served by their cooperation, each in its particular field.

It is sincerely to be hoped that future development of radio communication will be encouraged and stimulated by all possible means; that legislative control will be protective but not suppressive, and that excessive commercial monopoly of the science will not occur.—*Abstracted from Journal of Electricity.*

THE WINDING OF TOROIDAL COILS.

The particular advantage of the torus is that there is no external magnetic field. When two ordinary coils are connected in series and placed close together, the effective inductance also includes the mutual inductance, as shown by the familiar formula

$$L = L_1 + L_2 + 2M$$

$$\text{or } L = L_1 + L_2 - 2M$$

To reduce the mutual inductance, M , to zero, the coils must be put at right angles to each other or widely separated. Toroidal coils, however, can be stacked up on top of each other, yet because the mutual inductance is zero, the effect inductance is simply the sum of the individual inductances.

In this way individual tori can be made for the separate steps of the primary and secondary inductances of a receiver. Then, with dead-end switches, there is no loss whatever due to currents set up in unused coils. A separate set of ordinary coupling coils can be made for the coupling between the two circuits.

Inductance of a torus of circular section; that is, of a doughnut shape, is given by the formula

$$L = 12.57 n^2 (2.54 - \sqrt{6.4SR^2 - 2.54 a})$$

where L = inductance in cms.,

n = total number of turns,

R = the average radius of the torus, measured from the center of the ring, to the center of the cross section, in ins.,

and a = radius of the circular cross section, in ins.

>A coil of rectangular cross section has an inductance

$$L = 11.7 n^2 h \log_{10} \frac{r_2}{r_1}$$

where L = inductance in cms.,

n = total number of turns,

h = height of cross section, measured at right angles to the plane of the torus, in ins.,

r_1 = inner radius of the torus, in ins.,

and r_2 = outer radius of the torus, in ins.

Maximum inductance is obtained by making the coil of large cross section and as small inside diameter as possible. More than one layer can be used, but the formulas given above become slightly inaccurate for such a winding.—*Abstracted from Everyday Engineering for March.*

THE POULSEN ARC IN RADIO TELEGRAPHY.

Much has been heard of the Poulsen system in general terms during the last ten years—but very little in the form of precise details. Not only is the Poulsen system very much alive, contrary to belief in some quarters, and maintaining communi-

(Continued on page 659)

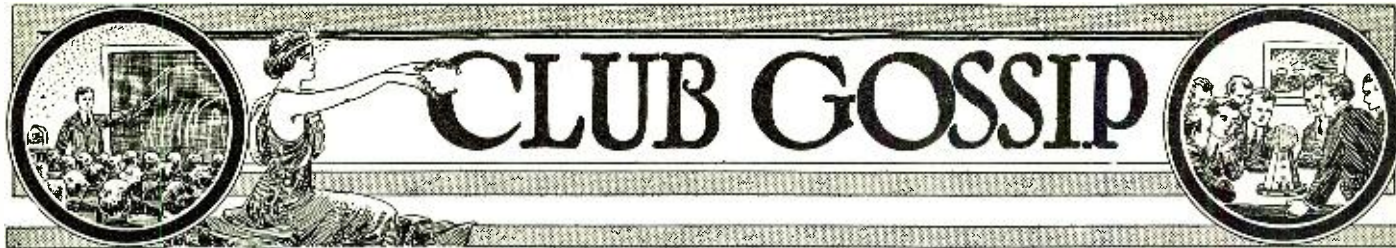

Carl Schurz Radio Club.

On March 18, 1920, the Carl Schurz Radio of Chicago was organized. We have a present membership of thirty. The club is under supervision of Mr. Vestal, High School Instructor of Physics. Officers were elected, which include: President, Albert Hedges; Vice-President, Herbert Harris; Secretary and Treasurer, Howard Olsen. We have a set under construction consisting of loose-coupler and audion control panel with condensers. In the near future we expect to make this the largest radio organization of the Chicago High Schools. Communications from other clubs would be greatly appreciated and should be addressed to the Secretary, Howard B. Olsen, 4145 N. Harding Ave., Chicago, Ill.

Wireless Club of Edison, Jr., High School, Harrisburg, Pa.

The Wireless Club of Edison, Junior High School was organized in October, 1919. The following officers were elected: Fred M. Mentzer, President; George Bennett, Vice-President; Charles Krause, Treasurer; Jess Meadath, Secretary and reporter to school paper, *Edison Record*.

Seventeen members are enrolled, all of whom are students of the school. The club was organized to give instruction to the students interested in wireless. Our club meets every Thursday afternoon from 1 to 2 o'clock.

The club has purchased a receiving set, one Galena detector, one pair 2,000 ohm phones, and also one 5,000 meter loading inductance. Arlington (NAA) can be heard ten feet from the phone and readable five feet away. We have a two-wire aerial 250 feet long of aluminum wire. The dues of the club are 25 cents per month.

We would like to hear from other clubs. Any club or persons wishing to communicate with the club may do so through the Secretary, Jess Meadath, 1411 Market St., Harrisburg, Pa.

Radio Club of Hartford.

The regular monthly meeting of the Radio Club of Hartford was held on Tuesday evening, April 6. Owing to the absence of the President, Mr. Walter B. Spencer, the meeting was called to order by Vice-President Edward L. Belknap. After the regular routine business was finished, Mr. W. F. Coleman, formerly a United States Navy operator, gave a very instructive talk on the subject, "Elements of Magnetism and Electricity as Applied to Wireless." Mr. Coleman told about the remote-control system used on United States battleships, and something of the duties and life of the radio operators aboard these battleships. Mr. C. D. Tuska was present and was asked to tell about his radio telephone set, which has been heard nearly every evening for the past two weeks by stations in Hartford and vicinity. Mr. Tuska told about his set and also spoke of the latest theory of the cause of fading signals. Six applications for membership were read and approved by the club. The meeting was then thrown open for general discussion.

The regular monthly meetings of the Radio Club of Hartford are held at the room of the Automobile Club of Hartford on the first Tuesday of each month. Every Tuesday except the first Tuesday in the month is devoted to practise meetings, at which new members and beginners in radio are given code practise on the buzzer and instructions in the construction and operating of wireless instruments. Amateurs located in Hartford and vicinity are urged to join the club and take advantage of the interesting and instructive programs to be carried out during future meetings. The club owns a good wave meter and has appointed a committee of competent radio operators to tune the stations of all amateurs who desire to have their stations brought up to the greatest efficiency. This service is maintained absolutely without charge.

Communications should be addressed to the Secretary, Maitland Steele, 378 Park Road, Hartford, Conn., or sent by radio to 1-DL.

Yates Radio Club.

The Yates Radio Club, which holds its meetings on Wednesdays of each week at 112 Head Street, Penn Yan, N. Y., is progressing very rapidly. A transmitting and receiving set has been procured as the club's property. A new resolution has been adopted to control QRM from 9 P. M. to 12 P. M. for out of town work. There is a membership at present of fifteen and half of this number hold 2nd grade licenses. The President will be glad to communicate with other clubs or radio men interested.

Address correspondence to William C. Babcock, President.

Wireless Society of London.

Mr. A. A. Campbell-Swinton, President of the society, delivered his annual address on February 27 at the Royal Society of Arts. The address (which was entitled "Some Wireless Wonders") was an exceedingly interesting one and was received with enthusiasm by the audience, which filled the lecture hall to overflowing. The address was illustrated by a series of experiments whereby the audience were shown the enormous strides which have been made in the science of wireless telegraphy since the last presidential address was delivered in 1914. A message which had been sent specially from Paris by General Ferré, a Vice-President of the Wireless Society of London, was made audible and visible on a screen to the audience, and in addition wrote itself out in Morse characters on a tape machine. This and other special messages from the Air Ministry and the wireless station of the Radio-Communication Company at Slough were received and made audible to the audience, not on the usual external aerial, but on a simple loop of wire standing upon the lecture table. Mr. A. A. Campbell-Swinton paid tribute to the Fleming valve, without which it would have been impossible to obtain these results.

The proposal for affiliation of provincial clubs and societies has met with most favorable response, and all the principal wireless clubs in Great Britain are now affiliated. A conference of these clubs, at

work and not merely for communications with other stations in a general way.

Admiral Sir Henry Jackson, at the close of the conference, in an able speech, pointed out how much in the past wireless telegraphy had benefited by the amateur experimenter.

Bridgeton Radio Association

For the purpose of studying wireless telegraphy and its branches, the Bridgeton Radio Association has recently been formed.

The following officers were elected: President, Alfred Turner; vice-president, Francis Sharp; secretary, Robert Elmer; and treasurer, Miss Della Maskell. There are eight charter members in the association.

At present the meetings are being held around at the various homes of the members, but in the near future they hope to have their own headquarters and an up-to-date set installed.

The association will be glad to hear from anyone interested in this work. Please address all communications to the secretary, Robert W. Elmer, 230 E. Commerce St., Bridgeton, N. J.

Albany Radio Club.

The regular meetings of the Albany Radio Club will be held every Monday evening instead of every other Tuesday, as previously stated.

The club has installed a receiving set of the latest type, and a number of distant stations have been received. A six-inch coil will be used for the time being for transmission, but it is hoped that it will be replaced by a transformer in the near future. In order to help the younger members in code practise a number of buzzer sets have been installed.

Wireless telephone from 2XB, New York City, has been received very QSA by a number of the members of the club.

Mr. E. C. Fasoldt, president of the club and the owner of a telephone set, has been giving concerts every Saturday night, and the music is enjoyed by amateurs within a radius of 15 to 20 miles.

We should like to hear from other clubs. Any one wishing to do so may communicate with Mr. Herbert H. Ammenheuser, Corresponding Secretary, Albany Radio Club, Y. M. C. A. Building, Albany, N. Y.

The Radio Club of Public School 109, Brooklyn, N. Y.

Our radio club was organized some time ago under the leadership of Mr. Theo. M. Bedwin, head of our science department, and the results we have obtained so far rival that of any such organization in the field, as we have in every case received a 100 per cent response of the classes asked, and were we to request it the whole school would respond instantly, man for man, as the enthusiasm is not only confined to the older boys, but ranges from oldest to the youngest.

We started out rather falteringly in this field, not knowing whether or not our set was to be a temporary or permanent affair, but have now decided upon the latter, and since doing so have improved it from a small old set to an up-to-date outfit and have set up an aerial of over 300 feet span. When we have installed our sending set we are going to increase it in length. Incidentally it is almost 100 feet high.

Members of the club are allowed many privileges, such as using the club's instruments, which include a full line of electrical things.

It is our aim to all become expert radio operators and toward this end we have regular code practice and can all take at a fairly good rate of speed. We have lectures on the theory and practise of radio demonstrations and experiments and are fast rounding into shape.

A few members are now the proud possessors of outfits, while many others are now constructing them. Most of the parts of these stations are made in shop. There are still others who, though they would like to make sets, can get no room for an aerial. These, however, are not put out, for they have purchased receivers. After school hours many of our boys come up and "listen in" and whenever they have any time off the only place you can find them is at our headquarters receiving the news of the world as it is flashed out.

We would be very much obliged if any amateur would call us up via radio between 1 and 3:30 p.m. Interested amateurs may communicate with Oscar Block, 385 Powell Street, Brooklyn, N. Y.

Geneva Radio Association.

The Geneva Radio Association has been formed in Geneva, N. Y., with a considerable membership and duly elected officers. Its object is the development of amateur interest and knowledge of wireless telegraphy. The association announces it would transmit radiograms to any part of the country free of charge.

(Continued on page 660)

**Radio Articles in
May Issue
Electrical Experimenter**

*The New Radio Corporation—by
C. D. Wagoner, of the General
Electric Co.*

*The Exploits of a Radio Detective
—by Pierre H. Boucheron*

*An American Girl's Radio Station
—by Miss Abby P. Morrison*

*A One-tube Radio Telegraph and
Radio Telephone Transmitter—
by Pierre H. Boucheron*

*Long Waves and "Strays" On
Rogers Antennae—by Lieut. Com.
A. Hoyt Taylor, U. S. N. R. F.*

the invitation of the Wireless Society of London, was held in the afternoon of the same day.

The conference was held under the presidency of Sir Charles Bright, F.R.S.E., supported by Admiral of the Fleet Sir Henry B. Jackson, G.C.B.; Captain F. C. Loring, R.N., representing H.M. Postmaster-General, and other Vice-Presidents and officers of the society, including Mr. Frank Hope-Jones, M.I.E.E., chairman; Major Basil Binyon, O.B.E., vice-chairman, and Mr. Leslie McMichael, hon. secretary. Wireless clubs of the following towns and suburban districts were represented by delegates at the conference: Burton-on-Trent, Plymouth (two clubs), Southport, Altrincham, Woolwich, Brighton, Sheffield, Manchester (two clubs), Stoke-on-Trent, Derby, Glasgow, Bristol, North Middlesex, and Peckham. Sir Charles Bright in his opening speech said that the object of the meeting was to discuss the general terms on which affiliation should take place, and whether future conferences should take place in London or in various towns from year to year. The President called upon Mr. Hope-Jones to welcome the delegates, after which the delegates were invited to express their opinions on behalf of their clubs and to ask questions upon matters on which they desired information. Captain Loring made an official statement in which he pointed out how strongly the Post Office officials were in favor of an amalgamation which would tend to keep amateurs within the limits of their license. He stated on what terms the Post Office proposed to grant transmitting licenses, viz.: A license of about 10 watts where an amateur could prove that he thoroughly understood the apparatus he was asking to make use of, that he was conversant with the Morse code and proficient, and that his transmitting station was to be used for genuine experimental



THIS Department is open to all readers. It matters not whether subscribers or not. All photos are judged for best arrangement and efficiency of the apparatus, neatness of connections and general appearance. In order to increase the interest in this department, we make it a rule not to publish photographs of stations unaccompanied by a picture of the owner. We prefer dark photos to light ones. The prize winning pictures must be on prints not smaller than 5 x 7". We cannot reproduce pictures smaller than 3½ x 3½". All pictures must bear name and address written in ink on the back. A letter of not less than 100 words giving full description of the station, aerial equipment, etc., must accompany the pictures.

PRIZES: One first monthly prize of \$5.00. All other pictures published will be paid for at the rate of \$2.00.

William M. Dailey Station

First Prize

THE accompanying illustration shows a photograph of my station and one of myself.

My set consists of the following instruments: 1 K. W. Thordarson Transformer, Home-made Condenser and Rotary Gap, Commercial Type Oscillation Transformer, and a line protector.

Receiving set consists of a six-unit De Forest type panel set, with a Deynor audiotron cabinet on the top; at the left of panel set are two large loading coils.

I have several different switches for both receiving and sending sets, and my phones are 3,000 ohms. I also have a set of honeycomb coils for panel set, and a loop aerial.

The above set has given me wonderful results. My aerial is

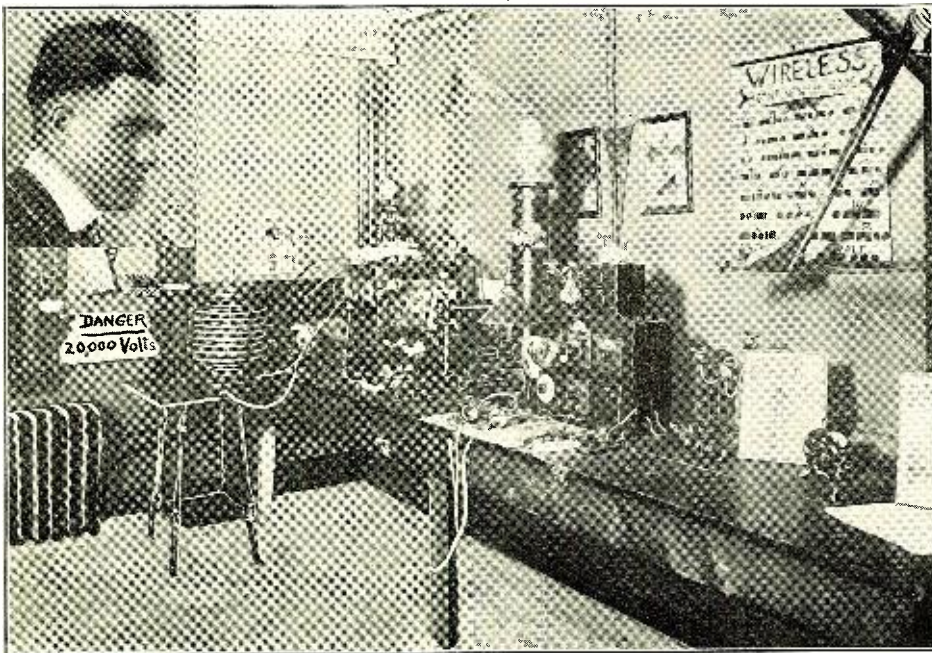

Mr. Dailey Makes Use of a Six-Unit De Forest Type Panel. This Makes a Very Good Looking Receiver. There Is Enough Room in This Station to Accommodate a Young Radio Club.

95 feet long, 4 wires, 3 feet apart and 75 feet high. My operating experience covers seven years.

As will be seen from the photograph my station is arranged in such a manner that I have plenty of elbow room, having constructed a bench which will hold more than the average amount of radio instruments. Not only this, but I have plenty of good light owing to the large window. I suggest to other amateurs that whenever possible, and providing space warrants it, they follow out the above bench idea. It will pay in the long run, and permits visitors and other operators to drop in at any time and "listen-in."

WM. M. DAILEY,
Cor. 13th and
Braddock Ave.,
Braddock, Pa.

Howard G. English Station

This is a photograph of my receiving outfit. A description of the instruments is also given as follows:

The loose coupler tunes to 3,000 meters, and with the primary and secondary loading coils shown in the center, I can tune to about 15,000 meters. The switchboard, audion control panel and tickler coil, which is at the extreme right, are all home made. The larger variable condenser of .001 mfd. capacity is used to aid in tuning the primary and the smaller one of .0005 mfd. to tune the secondary. The phones are Brandes' Superiors.

Mounted on the switchboard at the left is the test buzzer, which is used to adjust the crystal detector, shown in the center. The D. P. S. T. switch above the buzzer is used to disconnect the secondary variable condenser, when receiving certain stations. Next is a D. P. D. T. switch and is used to change from crystal to vacuum tube detector. The next one is also a D. P. D. T. switch and is used to connect the primary variable condenser either shunted across the primary, or in series with the ground.

The next switch is a S. P. S. T., and is

used to short circuit the primary variable condenser, when used in series with the ground, which eliminates it altogether. The other S. P. S. T. switch is vacant at present. Below this switch is a S. P. D. T. switch, which will be used to change from



This Amateur Has Not Yet Branched Out to Transmission. His Name Is English—Perhaps That Has Something to Do With It—No Sending Over There, You Know.

one crystal detector to another, altho I am only using one crystal at present. At the extreme right is the buzzer push button and above this a connecting block to connect two pairs of phones in circuit.

The aerial used to receive is a single wire about 225 feet long. I hear quite a few government and commercial stations, and also some amateurs. In the near future I intend to include a sending set in my station.

HOWARD G. ENGLISH.
221 W. Pine St., Shamokin, Pa.

AMATEUR STATIONS NOTE.

A considerable number of photographs and descriptions have been received at the office of RADIO AMATEUR NEWS which do not contain enough detail or are not clear enough to be reproduced for publication. Prospective contestants on this page should therefore remember that it is essential to submit photographs which are as clear and as large as possible. Now go to it, boys!

Robert W. Field Station

MY first set consisted of one vacuum tube, loose phones and condenser. This was before the war, and as soon as the Government closed up all amateur stations I started to work making my present set.

My present receiving set, which may be seen in the accompanying photo, consists of the following: Three Marconi vacuum tubes, sockets and rheostats for same, two audio frequency transformers, loose coupler, phones, honeycomb wound coils, primary and secondary condensers for same, grid condenser and grid leaks. With this set I have been able to copy POZ, GB, NPL, NSS, NDD, XDA, NFF, NAA and scores of others.

My sending set is also entirely home made, and it consists of a 3/4 K.W. closed core transformer, rotary

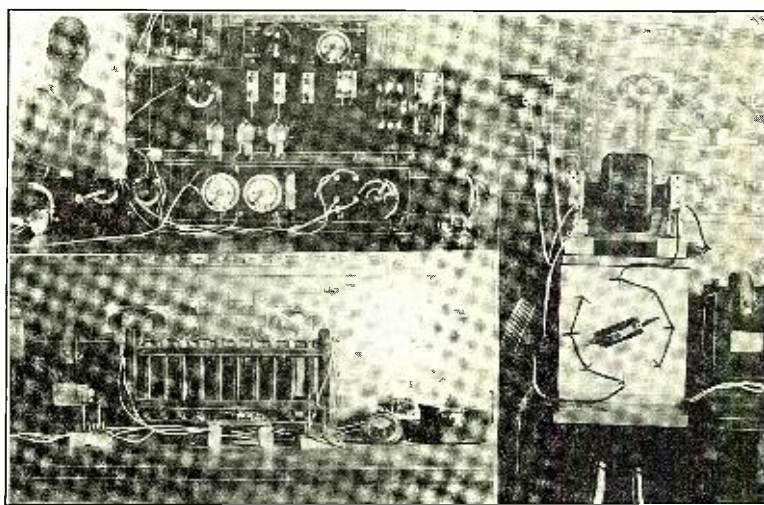

Three Views of the Field Station, including the owner. The Upper Left-Hand Cut is That of the Receiver; the Lower Left-Hand Shows His "A" Storage Cells and Home-Made "B" Batteries, While to the Right is the Transmitter Panel.

gap, glass plate condenser, and oscillation transformer. I hold an amateur's second class license, my call being 9AAS.

My aerial consists of two landed wires one hundred feet long and fifty-five feet high. I have been able to copy GB, NSS, NFF and others with my aerial on the ground.

From the photograph may be seen my home-made "B" battery, which was constructed with twenty test tubes. I have had considerable success with this battery and suggest that other amateurs also make their own, as it is one way to bring down the H. C. of "B" batteries. The construction details may be had from back numbers of RADIO AMATEUR NEWS.

ROBERT WILLIAM FIELD,
Owensboro, Ky.

F. J. Brott Station

The accompanying photographs show two pieces of my apparatus. The transmitter is of the panel type and is entirely of my own construction.

This design eliminates practically all of the losses in the leads of the primary circuit.

In constructing the transformer I used the secondaries taken from a Splitdorf automobile coil. The condenser was constructed from ten 7 x 10 photo plates and after assembly was boiled in wax.

The electrodes of the rotary gap were made from 1/4 inch square brass rod and the adjustment is such that they can be lined up perfectly.

A resistance is used in series with the motor to hold the speed down to about 2600 R.P.M. The panel measures 10 x 22 inches and the complete transmitter occupies a table space of 8 x 10 inches. The transmitter draws 180 watts from the line and with it I have communicated direct, with 6 FE. of Shasta County, Calif., a distance of about 460 miles; with 7 CC of Moscow, Idaho, about 200 miles and 7 ZB of Portland, Ore., about 140 miles.

My antenna is of the inverted (L) type consisting of 4 wires 46 feet long and 32 feet high.

F. J. BROTT.

Madison Park, Seattle, Washn.

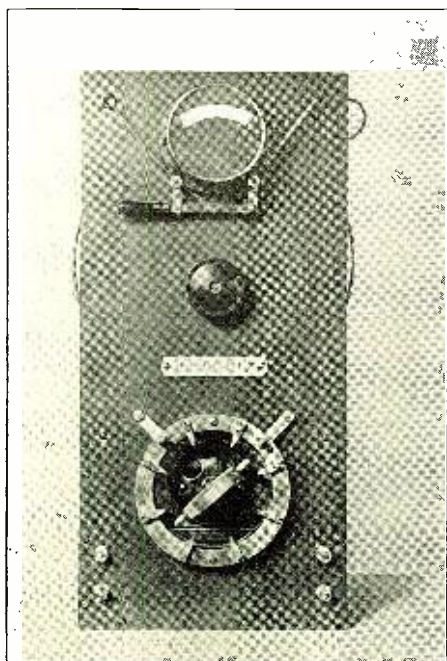

Not a Bad-Looking Panel Transmitter, Eh, Boys! Looks Real Commercial-Like.

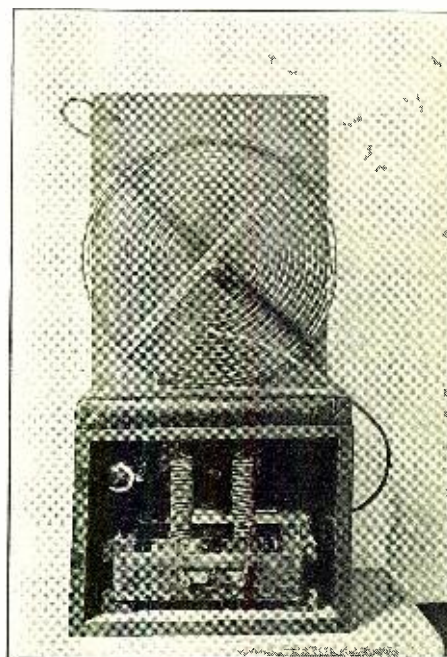

Rear View of the Transmitter With Inductance, Transformer, Condenser, and Rotary.

Floyd Johnson's Station

As I have seen few pictures of amateur's sets published with the De Forest unit set idea I thought I would send in a picture of mine, for the benefit of other experimenters. The description is as follows:

In the top row of panels are the coil mounting, detector and amplifier bulbs. In the next row of panels are the series or parallel switch for the primary condenser, rheostat for the detector, "B" battery control, audion-ultra, switch for two filaments in the detector all on one panel and in the next panel the rheostat for the amplifier. In the bottom row are the primary and sec-



Another Good-Looking Receiving Set Incorporating Twelve De Forest Units.

ondary condensers and a bridging condenser. In the lower right hand corner is the pull switch for the "A" battery and the binding posts for detector along or with the amplifier. The aerial is 80 feet long, 5 wires and 50 feet high at one end, 40 at the other. The sending set does not amount to much. It is a one-inch spark coil and condenser mounted inside of the box with the spark gap and helix showing.

FLOYD JOHNSON,
223 Kraker Ave.,
Joliet, Ill.

Pioneer Days in Radio Telephony

Reminiscences Dating Back to the Sputtering Arc, Uncertain Microphone and Variable Air Condenser That Broke Down in the Middle of a Test Conversation

By AUSTIN C. LESCARBOURA*

TWO groups of five hand-fed arcs; a button microphone that fried and baked solid at the end of two minutes; an array of instruments, controls and wiring covering a desk the shape of an overgrown upright piano; five kilowatts of honest-to-goodness direct current—all this for a range of barely twenty miles and, with exceptional luck,—not over five minutes of actual conversation. That, in brief, represents a typical set employed in the pioneer days of wireless telephony. What a contrast with the simple, long-distance sets of to-day, with their marvelous vacuum tubes! Yet this pioneer set which I am about to describe dates back only to 1908—a short span of twelve years as the affairs of the world go, but an age in the history of radio communication, to be sure.

During the latter part of 1908 and the beginning of the succeeding year, a number of radio telephone experiments were conducted by several wireless companies with a view to proving the practicability of their respective sets and receiving an order for equipment from the United States Signal Corps. The tests were between Fort Hancock, Sandy Hook, N. J., and Fort Wood, an Army post located on Bedloes Island in the shadow of the Statue of Liberty and in the heart of New York Harbor. The total distance between stations was eighteen miles as the crow flies, with the high hills of Staten Island intervening.

At the time in question the writer was in the employ of one of the competing concerns and aided in the operation of the transmitting set at Fort Hancock. What a remarkable experience, too, when viewed from the standpoint of to-day!

Fort Hancock is located on Sandy Hook—a long and narrow stretch of sandy waste extending north into the Atlantic Ocean and forming by its encompassing reach the lower portion of New York Bay. In summer the heat there is extreme, for the sun heats the unprotected sand until it is fit for use as a stove; in winter the winds blow over the sandy waste from all sides with Arctic snap and vigor. As an Army post, Fort Hancock is not held in very high esteem. So much for the setting of this story.

On a morning during the latter part of October, 1908, the writer and another man started for Sandy Hook on the U. S. S. Ordinance. This "steamer" was, in reality, nothing more than an exaggerated and luxurious tug boat, equipped for carrying freight and passengers to the many forts in New York Harbor and the Lower Bay. After a rough trip we arrived at Fort Hancock and made our way to the wireless station.

For those days the wireless station was all that could be expected. It consisted of a two-story concrete structure, with a wooden mast at the rear supporting an umbrella type aerial. The equipment consisted of a one-kilowatt transformer mounted in a cabinet with a muffled spark gap and leyden jar condenser, as well as a simple helix with adjustable clips. A large flat-top desk mounted the receiving apparatus, consisting of a large three-slide tuning coil, a silicon and an electrolytic detector, and a pair of Sullivan head receivers. A key was close at hand, as well as a change-over switch. The key, it is interesting to note here, comprised the usual construction, with the addition of a long lever passing thru a slot and into a tank of oil in the desk, where the contacts were located. The contacts

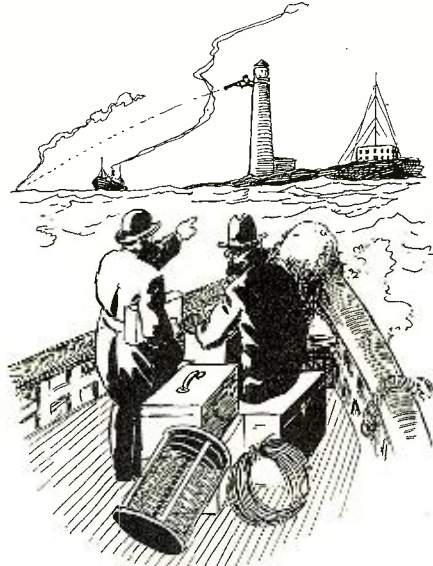

"On a Morning During the Latter Part of October, 1908, the Writer and Another Man Started for Sandy Hook. . ."

were the thickness of a crowbar—and all to break one kilowatt of primary current.

But to return to our wireless telephone set, which, after all, is the main theme of this story: Our set was mounted on a large table with a back-board. The transmitting set consisted of ten arc units in series, each unit comprising a copper cylinder filled with water, and a large carbon button held at the free end of a long spring member. The carbon button could be adjusted with relation to the copper cylinder electrode above it by a thumb screw located at the end of the bank of five arcs, where there was also an upright handle, much like an old-time Marconi key, which controlled the striking of the five arcs. In operation, the handle was prest down so as to strike the five arcs at once, and then the thumb screw was turned until the arcs burned steadily. The two banks of five arcs each were placed at either end of the table, while a large variable plate condenser, filled with paraffin oil, was set into the table top in the center. In the center, too, was a simple change-over switch for throwing in circuit either the

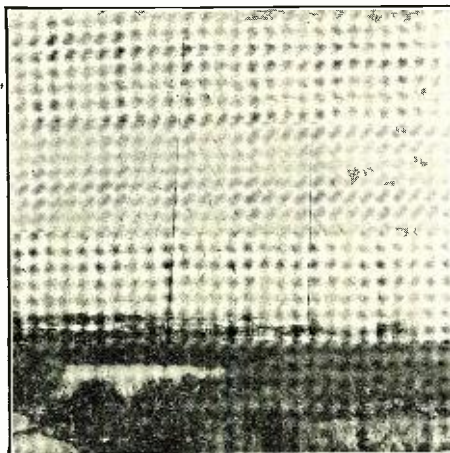

The Old "DF" Manhattan Beach Station Which Had a Deep Far-Reaching Voice; Long Since Dismantled.

transmitter or receiving set. Mounted on the back-board were two hot-wire ammeters, one for indicating the high-frequency current in the aerial circuit and the other for the energy in the oscillating circuit; a third ammeter of the standard magnetic type for indicating the amperage required by the ten arcs, and the receiving apparatus. The primary current was furnished by a 500-600-volt direct-current generator, directly coupled to a seven-horsepower 110-volt motor. Indeed, that seven-horsepower motor just about absorbed all the current generated by the post power plant, to the inconvenience of everyone else in the vicinity.

The microphones—and microphones in those days were one of the great problems in radio telephony—consisted of round, sealed metal cases about three inches in diameter. Each case had a diaphragm in front and an insulated contact on the reverse side. A number of these microphone units were always at hand when a test was under way, so that we could replace a diaphragm as fast as it became caked, merely by giving the mouthpiece a slight turn to get at the socket-like holder.

That first morning found the apparatus delivered and in place, but not installed for the good and simple reason that no one but ourselves knew the first thing about radio telephones. Soon we had the motor-generator set connected, and a special call to the local power house ensured us sufficient power to start up. One wire from the generator was attached to a tin can filled with water, while the other lead was connected with a voltmeter and then with a wire dipping in the water. By means of this crude resistance and a standard magnetic type voltmeter, it was possible to determine the polarity of the generator leads for the arc connections. The meter we had did not read higher than 125 volts, which accounts for the necessity of a water resistance!

The next step was to fill the ten copper electrodes of the wireless telephone set with water and to start the arcs. With the sputtering reduced to a minimum, the variable condenser, comprising 24 stationary and 23 rotary plates in a glass jar filled with paraffin oil, was then adjusted.

Someone has wisely said that patience is a virtue. In those pioneer days it was more than that—it was a necessity. For a full hour or more we would adjust the variable condenser while watching the fluctuations of the hot-wire ammeter in the oscillation circuit, then the arcs and again return to the variable condenser. With fair luck the ammeter would perhaps become relatively steady at last, indicating that the oscillations were constant.

The aerial circuit was then connected to the oscillating circuit, and no sooner done than the hot-wire ammeters started off on a wild career, calling for still further adjustments to perfect the coupling between the closed and open circuits. More patience, more work, and finally the meters would come to rest.

Acting quickly to take advantage of the happy situation, the microphone was slipped in place and one of us started shouting into the horn of the transmitter. At every sound the needles on both hot-wire ammeters showed a marked fluctuation, the variation being more pronounced the higher the pitch, and with phonographic sounds the greatest fluctuation was obtained.

Only a few minutes elapsed and then the ammeter needles would become inactive, in-

*Managing Editor "Scientific American"

dicating that the microphone had caked or baked or otherwise been rendered useless for the purpose. A wooden stick or screw-driver was then used to hit the microphone case, in hopes that the carbon grains might be shaken loose; but, failing in this, another microphone was substituted. In fact, it must have required remarkable courage to try to prove the practicability of such a set, when the microphone lasted no longer than five minutes and even during that short span of life had to be turned, hammered and otherwise humored along.

Another day, on a cold November morning, we found ourselves on the same boat as before, bound for Fort Hancock. On nearing the fort my companion and I became greatly excited on failing to see the wires comprising the antenna. We feared that the wires had been blown down by the gale that had swept the coast the night before. The pole was there, to be sure, but no wires. And how were we to carry on this day's test without an aerial?

But on reaching the wireless station we beheld the wires, still in place and intact. A close examination disclosed that these wires were of exceptionally small gauge, and that the lead-in consisted of but a single small wire. In fact, we came to attribute our failure to cover greater distances to the inefficiency of this aerial.

More trouble was waiting for us. On connecting the motor-generator set and trying to start up the 500-volt motor, we blew out the 60-ampere fuse in the cut-out. A study of the conditions soon disclosed the surprising fact that the armature was frozen tightly at the bearings, due to the extreme cold. A few minutes' work with the blow-torch playing on the bearings soon freed the armature shaft and our motor was not much longer in getting under way.

Still more trouble, this time in the shape of a broken glass jar on the variable condenser, also due to the extreme cold. The plates were thickly covered with oil and dust; the condenser was useless for our purpose, until it could be thoroly cleaned and placed in another jar. So we substituted another condenser of the same type and started up the arcs.

After the customary adjusting and manipulating operations the meters finally came to a relative calm, and we got down to the business of transmitting. The small phonograph which did most of the talking in our tests—it is so much easier to use a phonograph than for one to stand and talk into a horn without knowing whether anyone is getting the conversation or not—was put to work, singing the same record over and over again. But again we were confronted with still more trouble. The condenser broke down and short-circuited the oscillating circuit. A spark had jumped between two plates which happened to be irregularly spaced, and had broken down the resistance of the paraffin oil at that particular point.

Still another condenser was prest into service, and the test went merrily on. In the course of the afternoon a battleship passing by Sandy Hook on its way to the anchorage in the Hudson River, called us up by wireless telegraph and asked who we were. After being told, the battleship's operator vouchsafed the information that "The music is fine; give us some more." We heard later that all the officers on that battleship had been called by the operator to listen to radio-transmitted music.

In this and other tests, between times when the phonograph was not working, the conversation usually ran as follows: "Hello, hello, hello, Fort Wood; how do you get me now? One, two, three, four, five," and so on, most of the words being shouted very slowly and drawn out, into the large horn. During the afternoon in question our phonographic concert was heard at the Brooklyn Navy Yard, a distance of 20 miles.

The third and last test of this series, if the writer correctly recollects, occurred in January of 1909. After all the preliminaries now familiar to the reader, the phonograph was started and for upwards of an hour we did not think of changing the tune. The record happened to be "The Anvil Chorus" from *Il Trovatore*. We cared little about the music; our main concern was the am-meters, and they responded in great shape to this particular selection. An hour passed and still the Anvil Chorus kept agitating the ether in the immediate vicinity of Fort Hancock. Then we shut down for a few minutes, to give the operator at the wireless telegraph station an opportunity of listening in for an answer. No reply from Fort Wood, our objective in these tests. But

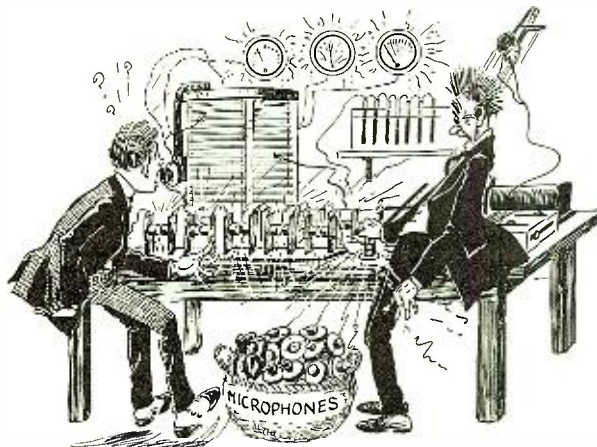

"The Aerial Circuit Was Then Connected to the Oscillating Circuit and No Sooner Done When the Hot Wire Ammeter Started Off on a Wild Career. . . ."

soon there came along a low, rambling spark, which proved to be the deep, far-reaching voice of old "DF", Manhattan Beach, with the plea: "Get you fine. But for C—sake change the tune!" We did. And all the rest of the afternoon we kept up our concert.

Later in the day we received a telegram—a telegram, mind you, and we were working in a wireless station! But that was back in 1908, don't forget, when radio was still in its swaddling clothes. The telegram simply stated that the tests might as well be abandoned as the interference in the Upper Bay was too powerful and persistent to permit of favorable reception.

The next boat left at four o'clock, so we wandered about the reservation in search of something interesting. We found it in the shape of the watch-out towers maintained by the two rival telegraph companies for reporting incoming ships at that time. We visited the first of these towers, and found there an old-time operator who had six wires to handle besides reporting the steamships sighted. Now at that time there was great rivalry between the two telegraph companies in this matter of reporting steamers, since it meant much prestige and business to the one which got most of the scoops, to borrow a good newspaper turn. The crafty operator whom we visited had erected a small wireless station in his tower, with the kind aid of local talent and his *carte blanche* to the post junk heap.

The plot thickens! This old-time operator would place the telephone receivers on his head and listen to the different steamers reporting to Fire Island, some forty miles away. Upon the first sign of smoke on the horizon, about an hour and a half later, this crafty individual would immediately telegraph to New York the name of the still invisible steamer. Meanwhile, the rival operator, craning his neck and popping out his eyes at the end of the most powerful marine telescopes available, would watch that thin trail of smoke in anticipation of

some identification marks such as the funnels. Half an hour later he might hazard a guess—but that would be forty minutes or more after friend old-time operator next door. For some time the unfortunate operator was baffled; in fact, the only answer he could get to his inquiry as to how old-time operator got so many scoops, was that the latter could recognize steamers by their smoke!

All good things soon come to an end. One can hardly hope to enjoy a monopoly in any one line for long; and so old-time operator's little stunt soon played itself out. One day a steamer was not so prompt in getting to Sandy Hook as our friend had calculated, and he accepted the smoke of a small coast tramp for an important liner. The story of the wireless leaked out, and this idea was entirely abandoned as far as the watch-towers were concerned. Yet wireless, after all, has come to take the place of these picturesque watch-towers, with their solemn-faced watchers and five-foot telescopes and battery of chattering telegraph sounders.

Twelve short years ago, yet how much has been achieved in radio since then! Arcs of such crude design have been entirely abandoned, and in their place we find the wonderful arc transmitters made in big units for long-distance work. Vacuum tubes have taken the place of arc generators for moderate distances. Modulators make unnecessary the use of extra-heavy microphones which only bake and cake and burn up after a few minutes' use, under the old system. Silicon and electrolytic detectors are relics of the past, and completely overshadowed by the ultra-sensitive vacuum tube detectors of today.

To be sure, the small arc was a mistake. It could not be anything else but impracticable in the long run. But remember, it was the only thing then available that would generate high-frequency alternating current for radio telephony. Perhaps no phase of radio history is more interesting than how all this pioneer work came to be sidetracked when other and more practical ways of generating the necessary high-frequency current were discovered.

All of which augurs well for the future of the art. What may we expect of the next twelve years?

ED. NOTE.: *We expect some real radio development which will be along V.T. lines and which certainly will spell the doom of whatever remains of the talking or singing arc.*

THE DICTIONARY HELPED OUT.

A municipality having to extend the electric supply mains called a meeting to consider estimates. The chief engineer had been called away, but the work was carried on in his absence. One of the items in the estimate was for "potential wires." A councillor asked, "What are potential wires?" No one knew. The clerk thought of consulting a dictionary. "Potential" was found and the meaning, "existing in possibility but not in reality," was decided to be the one applicable. That was the best they could do, so the council passed in the estimates, \$200.00, for "potential wires, or wires existing in possibility but not in reality."

Contributed by E. ALTMAN.

RADIO JOKES

Send us some original jokes or peculiar sayings associated with technical terms familiar to radio men. Here is an opportunity for ye would-be jokesters.—THE EDITORS.



Junior Radio Course

Transmission for the Beginner

THE young man starting out as a real amateur will seldom want to employ the latest word in transmitters, which means the use of quenched gaps, rotary gaps, large power transformers, motor generators, etc. It is more likely that in order to better understand the fundamentals of radio transmission he will want to start out with an ordinary, small size spark coil, let us say, for instance, one capable of discharging a two-inch spark between its secondary terminals when no other instruments are connected to it, and between two sharp needle points.

It is, therefore, a better way to start out on a small scale and gradually work up to the advanced experimenter stage which involves a better and more powerful grade of apparatus. Of these we will speak in a future lesson. For the present we are concerned with the functioning of an elementary transmitter circuit.

THE SPARK COIL.

Let us consult Fig. 1 which illustrates the wiring diagram of a practical yet simple transmitter suitable for the beginner. In the first place we have the spark coil, the function of which is to perform the following: to raise or transform the comparatively low voltage of the sending batteries to a voltage of many thousand volts. In other words where the batteries give a voltage of six or eight volts, it is the purpose of the spark coil to raise it to twenty thousand or more volts so that it will be sufficient to jump an air gap. Don't think, however, that the spark coil gives more energy than it actually receives, in fact, during the process of transformation, a small amount of energy is actually lost. What it does, however, is that while it steps up the voltage, the *amperage is lowered accordingly* so that the resulting secondary current of the spark coil is very small indeed.

In Fig. 1 the batteries furnish current to the primary winding of the induction coil when the power switch is closed and the

sending key pressed. This causes the core of the spark coil to become magnetized, thereby attracting the vibrator hammer. As soon as the hammer is attracted, however, the contact point of the vibrator is opened, thereby stopping the current flow through the coil. The core no longer being magnetized naturally releases the hammer which again closes the circuit. This make-and-break therefore occurs many times per second according to the pitch of the vibrator determined by the set screw. A large capacity condenser is connected directly across the vibrator contacts in order to reduce excessive sparking which would otherwise quickly burn up the contacts.

Owing to the many turns of fine wire in the induction coil secondary, a high voltage is induced into it and this high voltage is made to charge the sending condenser.

THE CONDENSER.

The sending condenser is for the purpose of storing up the high voltage energy until such time as the *potential and volume of the spark* has reached a sufficient value to jump the spark gap.

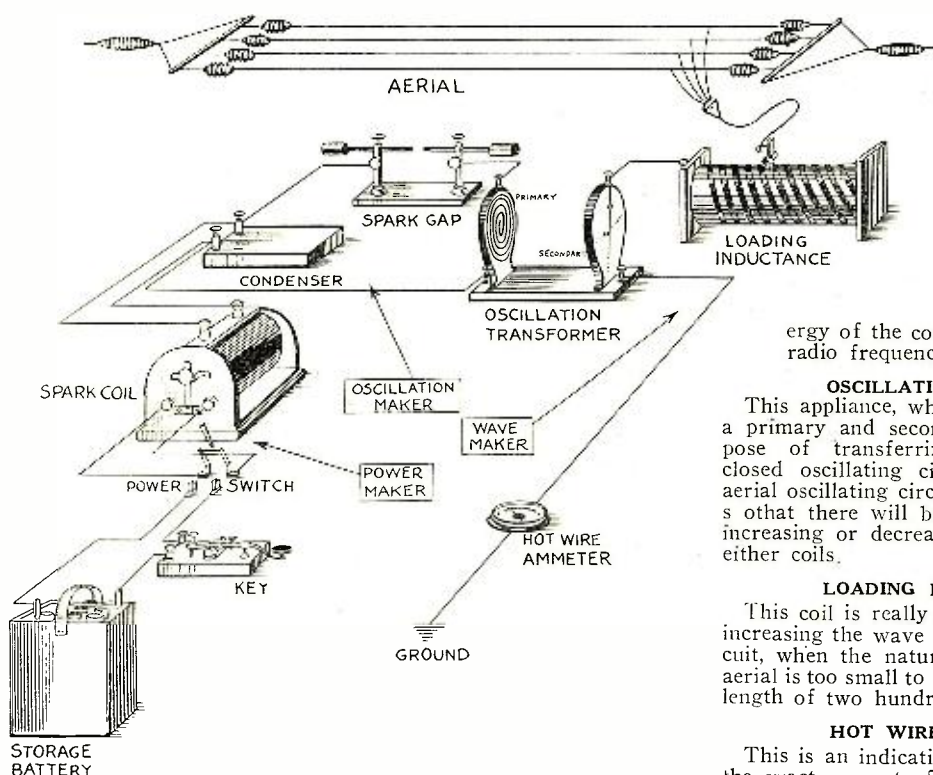

Fig. 3. This Illustration Shows a Perspective of the Transmitting Instruments Actually Hooked Up Ready for Work. The Ground of Course, Should Be Connected to a Water Pipe or Any Other Form of Ground Connection.

THE SPARK GAP.

The spark gap in a radio transmitter is designed to prevent any action taking place in the closed oscillation circuit until such time as the sending condenser is fully charged. When this has been reached its next duty is to discharge the stored-up energy of the condenser in the form of radio frequency oscillations.

OSCILLATION TRANSFORMER.

This appliance, which usually consists of a primary and secondary, is for the purpose of transferring energy from the closed oscillating circuit to the open or aerial oscillating circuit. It is also designed so that there will be a variable means of increasing or decreasing the inductance of either coils.

LOADING INDUCTANCE.

This coil is really an auxiliary means of increasing the wave length of an aerial circuit, when the natural wave length of the aerial is too small to secure the desired wave length of two hundred meters.

HOT WIRE AMMETER.

This is an indicating instrument showing the exact amount of energy being radiated into the aerial circuit when the sending key is pressed. It is also used as a rough means of telling when the degree of coupling between the primary and secondary of the oscillation transformer is proper for the least amount of *decrement*.

SUMMARY.

Referring to the diagram of Fig. 1 again, the dotted line circuit may be said to represent the high potential or *power maker*; the straight line circuit may be said to represent the *oscillation maker*, while the heavy lines may be said to represent the *wave maker*. In other words, the battery, sending key and the spark coil employ a low potential, or low voltage, at high amperage and transform this current to a very high voltage but low amperage energy where it becomes *oscillatory* (alternating back and forth rapidly) in the closed circuit. This oscillating energy is then transferred to the open aerial circuit *which decides at what wave length it shall travel in its propagation* after it has left the aerial. These three steps are always necessary in any radio transmitter, no matter what system is employed. Remember that Fig. 2 is a water analogy of the whole process and is for the purpose of showing you in a simple way, just how a transmitter works. The functioning and exact details of these three circuits as applied to the amateur set will be explained more fully in the next lesson.

Fig. 2, is an illustration intended to show you, by means of air and water analogy, just what takes place in a regular spark transmitter. The power maker may be assumed to be the pump, which in radio would be the battery. This pumps air into the compressed air tank, which in radio would be the spark coil. The oscillation maker may be represented by the rubber bladder within the water tank and which in radio would be the condenser. The blowing of air in and out of the bladder produces waves in the tank of water which is therefore the wave-maker and which in radio would be assumed to be the oscillation transformer. A stream of water is therefore pushed out at each inflation of the bladder. In radio this water stream would be the radiated wave.

Fig. 3 shows a perspective of the transmitter instruments actually connected ready for transmission.

QUESTIONS FOR THIS LESSON.

1. What is the purpose of the induction coil?
2. What is the purpose of the sending condenser?
3. What is the purpose of the spark gap?

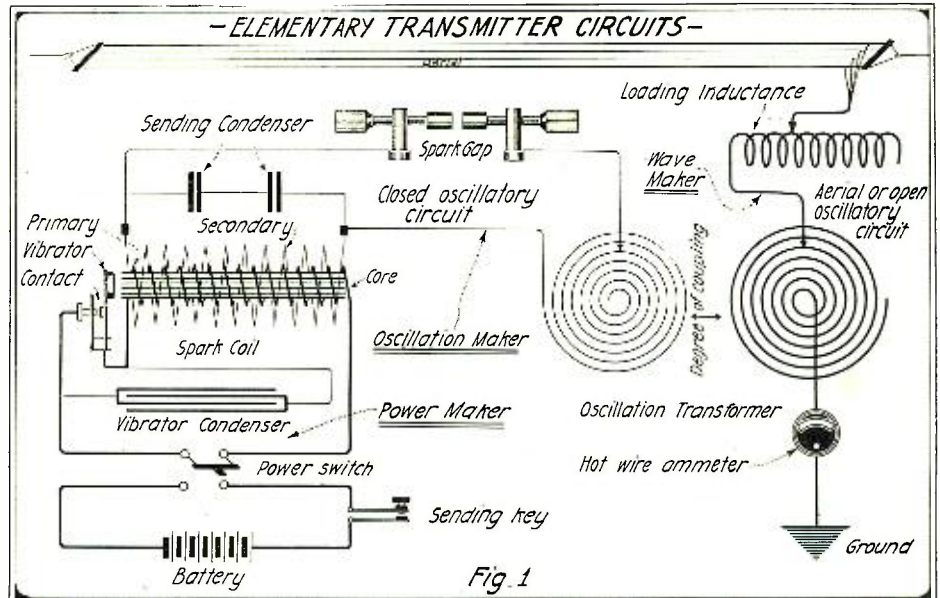

This is the Exact Transmitter Circuit Hook-up Which is to Be Studied Closely in Conjunction with Fig. 2 and Fig. 3.

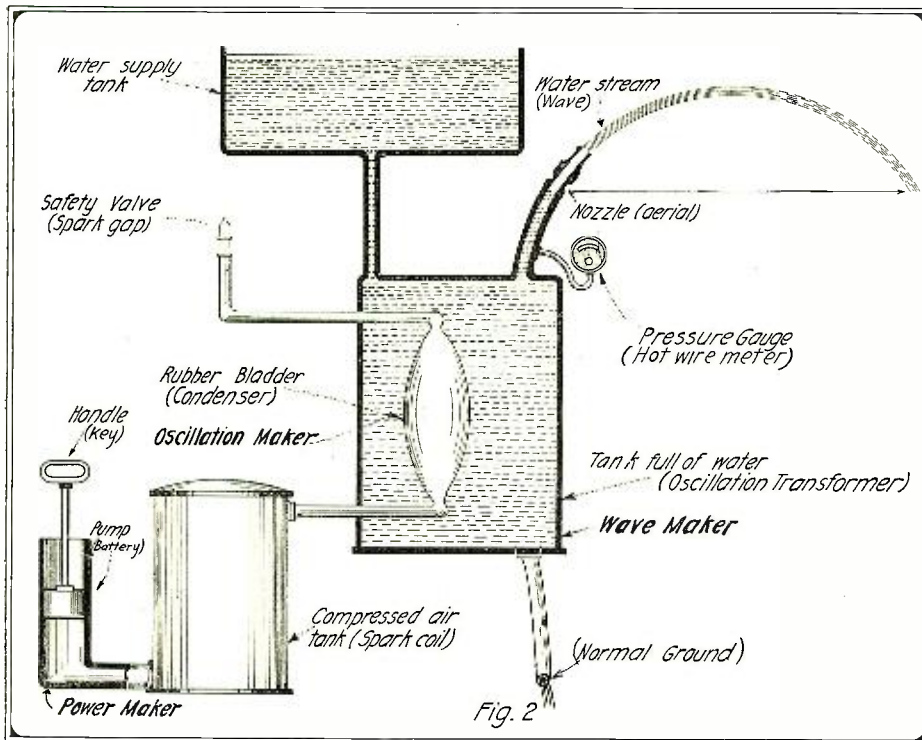

This Analogy Shows What May Be Assumed to Take Place in a Regular Spark Coil Transmitter. Study It Closely in Connection with This Article

4. What is the purpose of the oscillation transformer?
5. Name the three fundamental circuits described in this lesson?

out undue oscillation, and come to a "dead" stop.
 Dead Beat Discharge—Non-oscillatory discharge. One reaching its maximum rapidly and then slowly dying away.
 Declination—See Angle of Declination.
 Decoherer—See Tapper.
 Decrement—Rate of damping Natural log of successive current amplitudes in the same direction. Decaying percentage of an oscillation.
 Decrement, Logarithmic—The logarithm of the ratio of the amplitude of one oscillation to the next oscillation in the same or opposite direction. If the two successive oscillations are in the opposite direction then the decrement is called the decrement per semi-period, and if the two successive oscillations are those in the same direction the decrement is called the decrement per complete period.

Decremeter—An instrument for measuring decrement. See Wavemeter.
 Degree of Coupling—See Percentage Coupling.
 Delta Grouping—A method of connecting up three phase windings. The three lines are joined to three meeting points. Also called Mesh Grouping.

Density—See Specific Gravity.
 Depolarizer—Chemical substance used in a primary cell to prevent local action or polarization.
 Detector—Any apparatus which converts the oscillations received by the aerial into visible or audible signs. See Coherer, Crystal, Electrolytic, Magnetic, Vacuum Tube.

Dia-Magnetic—Meaning non magnetic.
 Diameter—Line passing thru center of a circle and terminated at both ends by the circumference.
 Diaphragm—Thin iron disc in a telephone which sets up the audible sound waves from vibrations caused by the periodic

(Continued on page 650)

Dictionary of Technical Terms Used in Radio Telegraphy and Telephony*

Damping—The dying down of amplitude in a train of waves, due to radiation from and resistance of an oscillating circuit.
Damping Factor—This refers to the numerical or algebraic expression giving the ratio between the amplitude of one oscillation and the one preceding it either in the same or opposite direction.
Daniell Cell—A Double-Fluid Cell, which consists of an amalgamated zinc rod im-

mersed in a dilute solution of sulphuric acid contained in a porous pot, which is in turn immersed in a solution of copper sulphate contained in a copper pot. The $CuSO_4$ is the depolarizer. Gives a constant tho low E.M.F. at 1.1 Volts. The internal resistance is also fairly constant.
D.C.—See Direct Current.
Dead Beat—Instruments whose pointers move to their final position steadily with-

* This Dictionary started in our March issue.

Junior Constructor

INCREASING INTENSITY OF "SIGS."

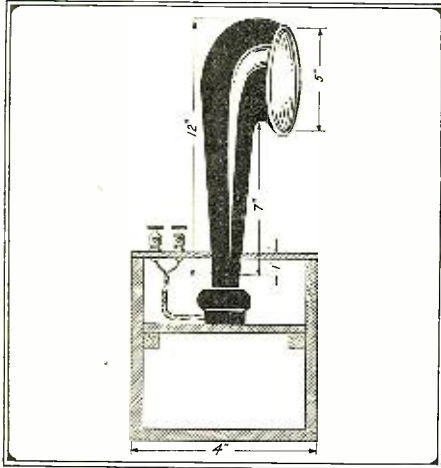

This Improved Sound Amplifier May Be Readily Constructed By Any "Bug."

Not having enough phones to go around when I had the "gang" up to the radio shack, I hit upon what I think an excellent solution. Take a box 4" square thru which drill a hole 1" in diameter. In this hole put a tin horn as shown in drawing. Before fastening on the lid fasten a 1,000 ohms receiver according to drawing. The case and horn can be painted, black for the horn, and oak for the case. This makes an excellent looking piece of apparatus. When in use it allows all present to copy all messages coming in. Make one of these receivers and sing, "Down with the H. C. of R." (high cost of receiving).

Contributed by JACKSON F. HOPE.

EFFECTIVE KEY CONTACTS.

We have devised a new idea for making a heavy key out of a light telegraph key. The first operation is to remove the old contacts and tap the holes to fit 6-32 switch taps, which can be found in any wireless amateur's junk box. Screw taps into holes made to receive same. The key is then completed except for filing the contacts until both surfaces come flatly together. If the contacts spark and burn up too quickly shunt a small capacity fixt condenser across them. You will find you have a neat and inexpensive wireless key.

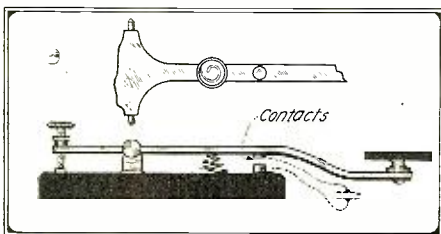

When the Old Contacts Are Worn Off Your Key, Make Use of Two Switch Contact Points in This Fashion.

Contributed by E. and B. BROCKWAY.

AN AUDION FOR THE AMATEUR.

In the article by James DeLaney in the February issue of RADIO AMATEUR NEWS he says "the main difficulty in the making of a vacuum tube is getting a good vacuum." I tried making a vacuum tube from his instructions and I used the following

method of getting a vacuum, which gave good results: After the elements have been sealed in with sealing wax, get a one hole rubber stopper and insert the end of the glass tubing half way into it as shown. Then get a piece of glass tubing 35 inches long and insert it in the rubber stopper until it touches the other glass tubing. Then obtain a cup and put some mercury into it. Pour the glass tubing and the test tube full of mercury. Then, holding your finger over the end of the long glass tubing so the mercury will not run out, put the end under the mercury in the cup and take away your finger. The weight of the mercury will cause it to run partly out of the glass tubing and leave the test tube with a good vacuum. All that remains to be done is to seal off the short glass tubing above the rubber stopper. The long glass tubing below the stopper will be as good as ever and can be used again. The mercury, of course, can be used again, too. These tubes are not expensive and are easily

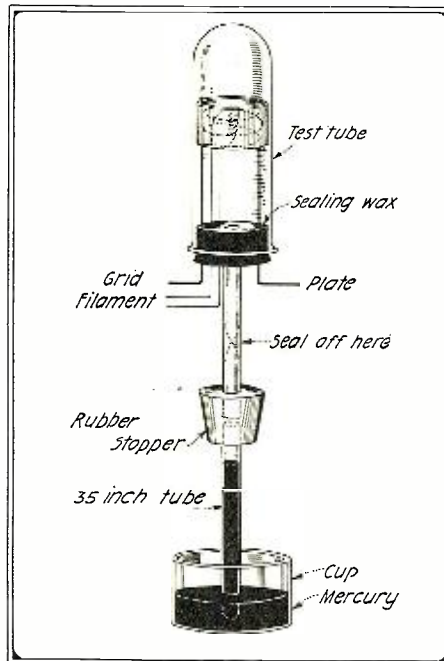

By Following This Method, Any Fourteen Year Old Boy May Construct His Own Vacuum Tubes.

made, so if you are industrious you can have a two step amplifier, or a seventeen step amplifier, for that matter. Also you might try making the filaments out of tungsten obtained from an old electric light bulb, thus making the filament last longer.

Contributed by JERROLD SWANK.

ANTI-CAPACITY SWITCH.

In some hook-ups an anti-capacity switch is a valuable asset because of its lack of condenser effect. The switch described herewith requires very little construction ability and serves the purpose admirably.

The switch is constructed from a receiver hook and the internal apparatus, the kind that usually is used with a watch-case receiver. The receiver hook switch is mounted on the panel in the regular manner, cutting a slot in the panel to allow for the passage of the hook. The hook part is cut off and the end "B" is wrapt with tape which serves as a handle. The middle lead is the main one.

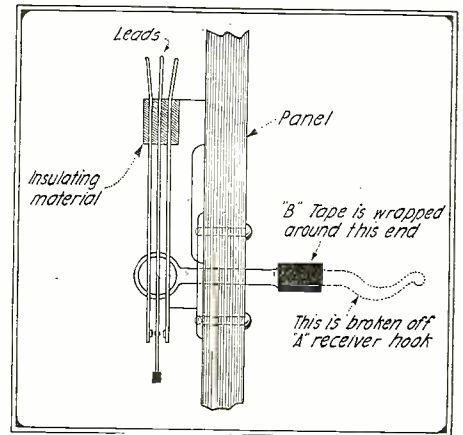

Visit the Local Telephone Exchange and Ask Your Friend for a Few Discarded Receiver Hooks, Then Build Yourself Some Anti-capacity Switches.

As the drawing alone supplies all the necessary information all further explanation is unnecessary.

Contributed by L. T. BEALL.

A NEW IDEA IN ROTARY SPARK GAPS.

This idea is for those who are blessed (?) with a slow motor for their rotary spark gap. As I am one of them, I know what it is like. In the scheme presented here there are eight stationary electrodes, four connected to one terminal and four to the other, mounted on a hard rubber panel, stiff cardboard will do, and a rotor which has six points, each mounted at an angle of 60 degrees to its neighbor, the result of this arrangement is as shown in the small drawings—1, 2, 3. In position (1) the vertical electrodes are in line and a spark gap is formed. As the rotor continued to turn in the direction indicated when the first electrode on the rotor has traversed one-third point on the stator and another spark passes as in (2). When another third of the distance has been traversed by the first point another spark gap is formed, as in (3). The first point, upon traveling the remaining third of the distance again becomes active.

Therefore you can see that for every time a certain point in the rotor passes between two neighboring points on the stator, the spark gap has been in action three times.

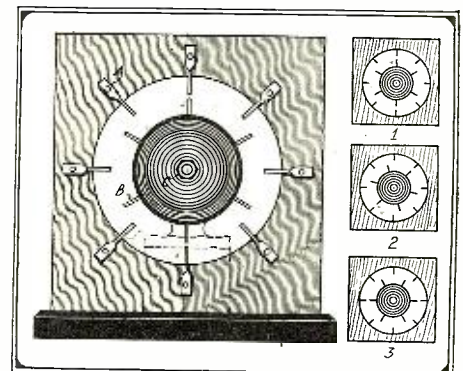

Speed up That Rotary Spark Gap of Yours By Making Use of This Scheme.

This is the same as increasing the speed of your motor three times.

Any number of points can be used, providing the number on the stator and the number on the rotor are kept in proportion.

Contributed by EUGENE M. RIEL.

NOVEL EMERGENCY SWITCH POINTS.

While experimenting one evening with a new radio hook-up the necessity arose for

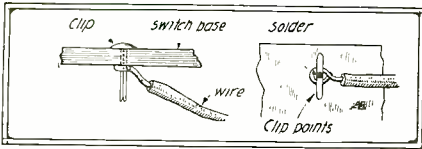

These Emergency Switch Points May Be Had By a Search In Your "Junk Box."

a multi-point switch. A number of paper fasteners, or Clips, were discovered, and since the tops resembled switch points, it was decided to use them. Holes were drilled thru the switch base as for ordinary switch points, and the wire wrapt about the points that protruded from the back. The points were then spread and flattened out with a hammer and a drop of solder placed between the brass points and the wire. These impromptu points gave excellent service.

Contributed by JESSE J. HIPPLE.
C. M. M. U. S. N.

SIMPLE GALENA DETECTOR.

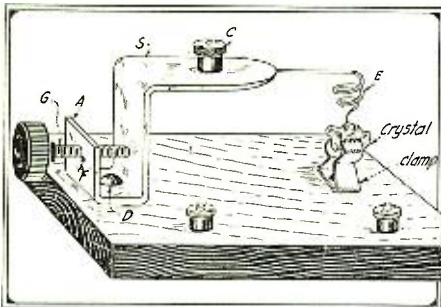

Here You Are Beginners. This Detector Will Cost But a Few Cents.

This detector is easily made and is well suited for galena. S is a strip of metal bent and cut as shown in which a small hole is drilled at F and a small nut A soldered on to admit tension screw G. S may be placed between washers at D so it may be moved sideways. The crystal is held in a light clamp as shown and contact made by the fine wire E which is soldered to S. The adjusting is done by knob C and the tension screw. No dimensions are given as an idea of the size may be obtained from the drawing.

Contributed by JULIAN PARVIN.

A FOOL-PROOF AERIAL SWITCH.

In the construction of an aerial or change-over switch, the importance of opening the primary circuit of the transmitter when in the receiving position should not be forgotten. Otherwise an accidental pressing of the key is likely to damage the apparatus, to say nothing of the operator's nerves!

This switch is made of an ordinary three-pole fused entrance switch. The center switch blade is removed and a blade

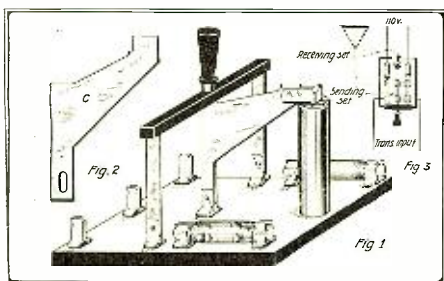

Here is a Fool Proof Aerial Switch and the Method of Connecting it to Your Antenna and Ground.

of the shape shown in Fig. 2 substituted. This blade is cut out from sheet copper or brass. No dimensions are given, since they will vary with different switches. The center fuse clips are removed and an upright of wood or other insulating material is attached. A switch jaw is fastened on the top of the upright so as to engage with the blade C.

This design, while it gives a quick throw switch, widely separates the receiver terminal from all parts of the transmitting circuit. When in the receiving position both sides of the primary circuit are opened. This and the fact that the circuit is fused makes it possible to use the switch as a combination aerial switch and cutout. It is connected as shown in Fig. 3.

Contributed by FRANCIS S. WILLIAMS.

A LOOSE COUPLED LOADING INDUCTANCE.

A good loading inductance is essential in all up to date receiving sets. The inductance described below is readily adaptable to any set, but is especially constructed for use in portable or on panel sets, on account of its compactness and ease of mounting. The overall size of the one used for loading from six hundred meters to twenty-five hundred only three inches in diameter and one inch thick.

The forms, two in number, are turned out of hard rubber, bakelite, or wood three-eighths of an inch thick. They may be made any diameter to conform to the needs of the constructor, the author's being three inches in diameter. A groove, one-eighth of an inch wide and one inch deep is cut in each disk. One hundred and seventy turns of number twenty-eight double silk covered wire is wound in each groove. Holes are bored in one disk to fasten it to the panel with screws or bolts, while the other disk is hinged to the first to enable the coupling to be varied. A small insulated knob fastened to the hinged disk completes the instrument.

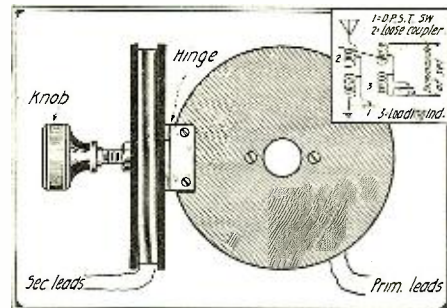

This Loading Inductance May Be Found of Value for Both the Primary and Secondary Circuits of the Loose Coupler.

In use, one coil is connected in series with the primary, and the other in series with the secondary. A small double pole double throw switch 1 (Fig. 2) is employed to short circuit the loader when short waves are being intercepted. The instrument was designed especially for use with the six hundred meter Signal Corps coupler, in conjunction with which signals from Arlington being very readily copied as far away as Boston.

Contributed by ROBT. W. DENNIS.

IMPROVED LIGHTNING SWITCH.

Here is a sketch of a switch useful for grounding the aerial. 1, 2 and 3 are old telephone receiver shells. The large ends are mounted on a base of wood, equal distances apart. The switch jaws, which were taken from an old entrance switch, are fastened to the small ends of the receiver cases. The switch blade 4 is made from a large strip of copper and has a large insulated handle 5. This instrument is easily constructed and is very effective as a lightning switch.

Contributed by EARL H. FURMAN.

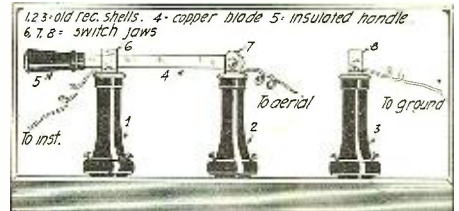

Be Sure to Fasten the Old Receiver Shells to the Base in a Secure Manner.

Contributed by EARL H. FURMAN.

A PERMANENT ANTENNA CONNECTION.

Take a porcelain tube and run the lead-in wire through it until it reaches the place where the antenna is connected to the lead-in wire. Now stand the tube upright and pour melted solder in it. When the solder cools the tube can be broken with a few strokes of a hammer, leaving only the lead

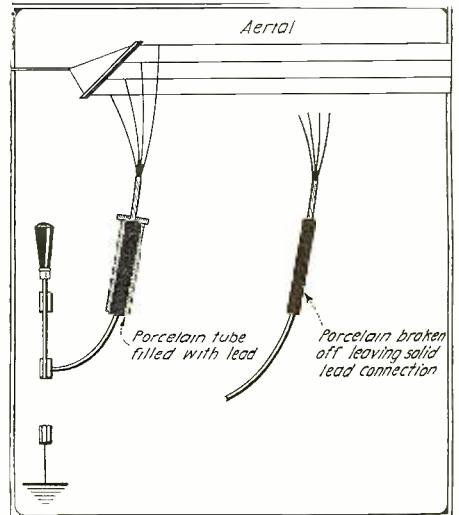

If This Idea is Followed Out You Will Experience no Future Trouble With Loose or Grinding Lead-in Contacts.

with the wires connected inside. This is a very desirable method of permanent connection, as the wires are not likely to be disconnected.

Contributed by ALBERT McGUIRK.

A MICROPHONIC AMPLIFIER.

A 1500 ohm receiver is fastened to the bottom of a small cigar box, which acts as a resonator. The box is slightly elevated from the table by four tacks such as are used under telegraph sounder bases. Visit your doctor and secure an old stethoscope which is attached to the top of the cigar box in a hole cut in the lid directly over the receiver. This arrangement greatly increases the audibility of even the weakest radio signals.

Contributed by ALBERT B. FULLER.

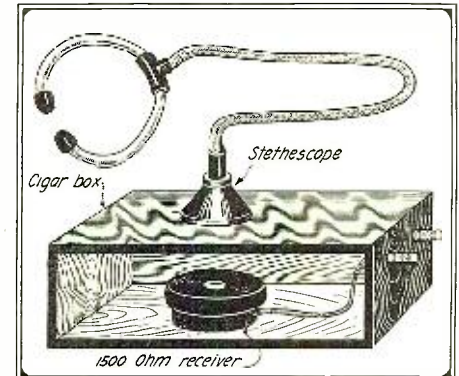

If Your Father is a Doctor Don't Appropriate His Best Stethoscope—Ask for an Old One.

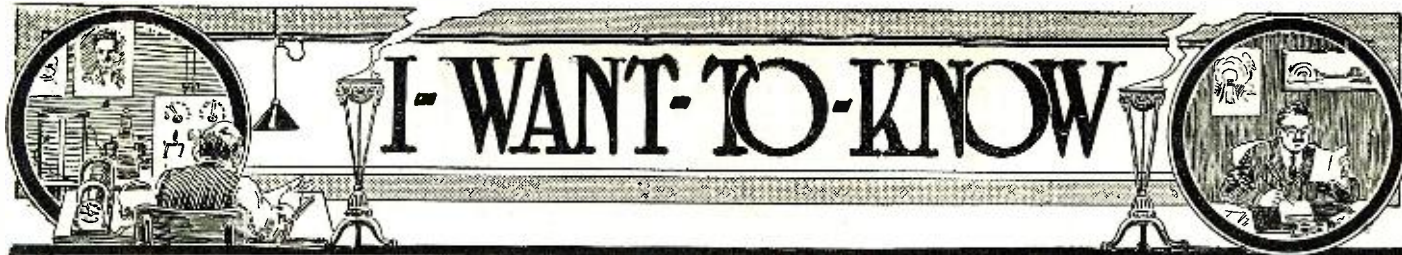

THIS Department is conducted for the benefit of our Radio Experimenter. We shall be glad to answer here questions for the benefit of all, but we can only publish such matter of sufficient interest to all.

1. This Department cannot answer more than three questions for each correspondent.
2. Only one side of the sheet should be written upon; all matter should be typewritten or else written in ink. No attention paid to penciled matter.
3. Sketches, diagrams, etc., must be on separate sheets. This Department does not answer questions by mail free of charge.
4. Our Editors will be glad to answer any letter at the rate of 25c for each question. If, however, questions entail considerable research work, intricate calculations, patent research, etc., a special charge will be made. Before we answer such questions, correspondents will be informed as to the price charge.

You will do the Editor a personal favor if you make your letter as brief as possible.

A RECTIFYING BULB CIRCUIT.

(162) Louis Smith, New York City, wishes the following:

Q. 1. Please publish an elementary circuit

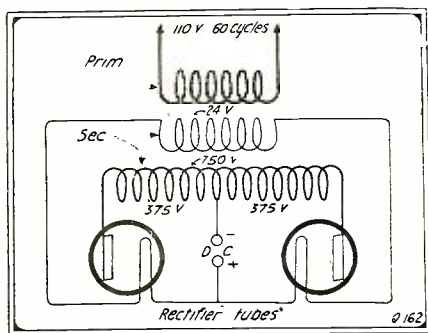

Elementary Circuit Diagram of Two Rectifying Bulbs Suitable For VT Work.

diagram of two rectifying bulbs converting A.C. to D.C. for operating vacuum tubes.

A. 1. A suitable diagram making this possible is shown in the accompanying illustration.

Q. 2. What is a Tungar rectifier?

A. 2. This is a trade name applied to a certain class of rectifying bulbs having an incandescent cathode as well as a plate. This instrument is used for the rectification of alternating currents and is suitable for the charging of small storage batteries, etc.

Q. 3. Can a rectifying bulb be used to secure the high plate potentials necessary in vacuum tube work?

A. 3. Yes, this may be done, in fact there are several types of rectifying bulbs on the market to-day suitable for this work. By using a step-down transformer having two secondaries, current is not only applied to the plate, but additional secondary furnishes the filament heating current as well. The circuit diagram of question one shows how this is done.

RECEIVING AND TRANSMITTING DISTANCES.

(163) H. J. Becker, St. Louis, Mo., writes:

Q. 1. How far can I receive with a crystal detector, 3,000 ohm phones, a Mignon "R. C. 1", damp wave receptor with an aerial 75 feet long, 40 feet high, with 4 wires?

A. 1. Beginners should understand that there is no definite way in which anyone can tell them how far they can receive with a given set of apparatus. At best, it is all guess work. The reason for this is that there are many conditions to be taken into account which differ with each individual and locality. In your case, we would say roughly 500 miles under favorable conditions.

Q. 2. How far can I send with a 1/2

K.W. Meteor transformer, rotary spark gap of 2,000 R.P.M's., a Meteor glass plate condenser using the same aerial mentioned above?

A. 2. In this instance also, no one can tell you definitely what distances you will be able to cover. It depends entirely upon the general efficiency of your set, in other words, location of your aerial, adjustment and tuning of your oscillating circuit as well as the individual effectiveness of the distant receiver. In your case, the approximate average sending distance should be about 25 miles, though, of course, you may do better than this under favorable conditions.

ALWAYS USE A LIGHTNING SWITCH.

(164) Walter Schmitt, Covington, Ky., wants to know:

Q. 1. Is it always necessary to employ a lightning switch in connection with an outdoor aerial?

A. 1. Yes, it is considered a good and safe practise to make use of a lightning switch with any type of aerial no matter where located. Be on the safe side and protect your instruments, as well as yourself and your house.

USE OF SAME DETECTOR AND AMPLIFIER BATTERIES.

(165) Bill Dohoney, Amarillo, Texas, asks:

Q. 1. What are the connections and capacities for a two step amplifier?

A. 1. A suitable hook-up for a two step amplifier appeared in the April issue of RADIO AMATEUR NEWS on page 565. The only condenser used in this amplifier circuit proper is of a very small capacity, such as .0001 or smaller and can easily be made by yourself with several sheets of wax paper and tin foil. (See Amplifier Notice, page 650.)

Q. 2. Can the above amplifier be used with the same A and B batteries that are used for the detector?

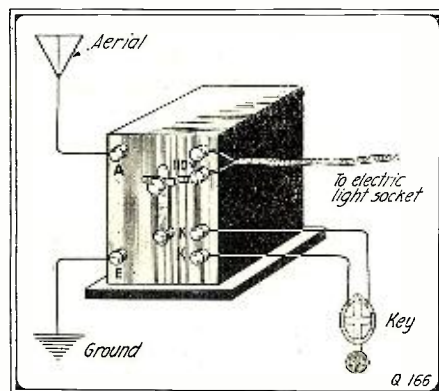

This Small A.C. or D.C. Transmitter Is The Real Thing for Beginners.

A. 2. Yes, but it is not good practise, in fact for some circuits it is not possible.

Q. 3. Can a 45 volt battery be used with a Marconi VT as a radiophone transmitter and how far will it transmit?

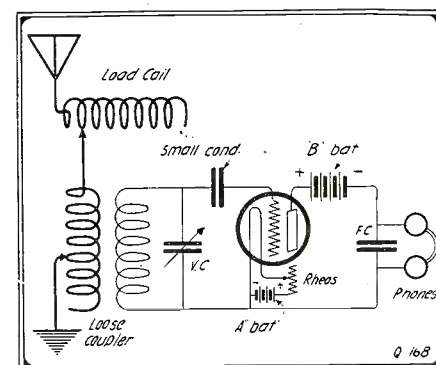

This Is A Typical Amateur Receiving Hook-up Using One Vacuum Tube As Detector.

A. 3. A 45 volt plate battery is not sufficient for radiophone transmission in order to secure good results. You should have at least 200 volts or more. You can, of course, experiment with lower voltage batteries and for very short distances.

SMALL EFFICIENT TRANSMITTERS.

(166) John Paulson, San Diego, Cal., wishes to know:

Q. 1. Are very good results secured with buzzer transmitters?

A. 1. Yes, considering the small amount of power they require, they are excellent for short distance work.

Q. 2. Does the Vibratone transmitter emit a sharp enough wave so as not to cause interference, and what is the circuit diagram of same?

A. 2. The Vibratone transmitter is well adapted for short distance work and, as far as we know, emits a fairly sharp wave. A diagram of this transmitter is shown in the accompanying illustrations.

UNDERGROUND RADIO.

(167) C. M. Davidson, Montclair, New Jersey, writes:

Q. 1. What is the wavelength of an aerial 160 feet long, 45 feet high, and a lead-in of 100 feet?

A. 1. The natural wavelength of your aerial is approximately 600 meters, and is altogether too long for amateur work, if you intend to use it as such.

Q. 2. Would an underground antenna be better for receiving and transmitting if it was 100 feet long, buried 3 feet deep and had a lead-in of 25 feet?

MURDOCK No. 55

IN APPEARANCE
THESE 'PHONES
SATISFY THE RE-
QUIREMENTS OF
THE MOST CRIT-
ICAL.

IN OPERATION
THESE 'PHONES
SURPASS IN SENSI-
TIVENESS THE EX-
PECTATIONS OF
THE MOST OPTI-
MISTIC.

2000
OHM
COMPLETE
DOUBLE SET
\$4.50



3000
OHM
COMPLETE
DOUBLE SET
\$5.50

IN DURABILITY,
THESE 'PHONES
WILL SERVE AS
LONG OR LONGER
THAN ANY.

IN RELIABILITY,
THESE 'PHONES
YIELD TO NONE,
THEIR CONSTRUC-
TION INSURING
"ALL-THE-TIME"
SERVICE.

RIGHT IN PRICE AND IN PERFORMANCE

The substantial success earned by these receivers can be attributed to the instant recognition and acknowledgment of their remarkable value, by thousands of users. If, by chance, **you** are not acquainted with their merits, or are dubious regarding the possibility of securing really good 'phones at such prices, we suggest a trial, with the customary assurance of "satisfaction or money back."

Our Bulletin No. 19B Illustrates and describes the Complete Line of Reasonably Priced MURDOCK APPARATUS. A Copy Will Be Sent at Your Request.

WM. J. MURDOCK CO.

50 CARTER ST.

CHELSEA (BOSTON 50) MASS.

509 MISSION STREET,

SAN FRANCISCO, CAL.

A Wireless Message from Detroit

Licensed Radio Operators are in constant demand by the Commercial Land Radio Service, Telegraph Companies, Merchant Marine, Lake and Ocean Steamship Lines, etc.

Minimum Salary of \$125 per Month, Plus Board and Room

is now being paid. Many operators are receiving much more than that.

Our course in Radio Telegraphy, under the direction of S. W. Edwards, U. S. Radio Inspector, offers the highest class instruction available. New, complete equipment. Day or evening classes. Opportunity to earn expenses while here.

Our day class prepares for First-Class Radio Operator's examination in three months, night class in 18 weeks.

Before deciding where to get your Radio training, write for our Free Illustrated Booklet.

Detroit Institute of Technology
303 Y. M. C. A. Bldg., Detroit

Old Town Canoes

Form a canoe club. We will furnish constitutions and by-laws. You can pick a fleet of "Old Town Canoes" from the new 1920 catalog. Thirteen graceful models pictured in natural colors. Complete list of accessories. All prices given. First cost is the last—there is no upkeep to an "Old Town". Write for free, postpaid catalog today.

OLD TOWN CANOE COMPANY
935 Fourth Street
Old Town, Maine, U. S. A.

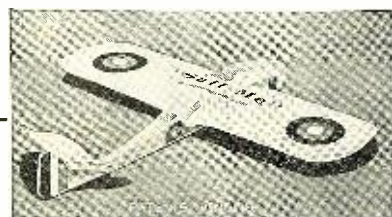

"Sail-Me" The Wonderful Miniature Airplane

Pronounced by Aviators as scientifically correct. Sample will be mailed on receipt of ten cents. Quantity prices on request. "Sail-Me" will duplicate the stunts of the most daring aviator.

C. J. VAN HOUTEN & ZOON (Sole Distributors)
R-732 Marquette Bldg., Chicago

A. 2. We cannot say that you will be able to secure the same results with an aerial of this type.

Q. 3. Where can I secure information on underground aeralis?

A. 3. An article appeared in RADIO AMATEUR NEWS on page 274 of the December issue entitled "Underground Radio Made Possible for the Radio Amateur," by

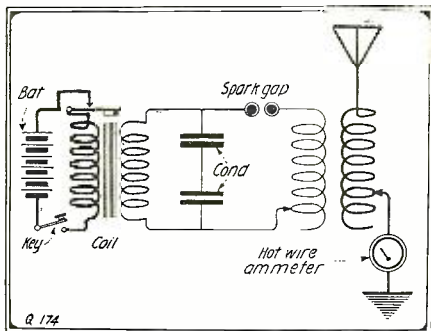

We Suggest That Beginners Copy This Typical Spark Coil Transmitter.

E. T. Jones. You may be able to secure some good information by referring to this copy. A complete book on underground radio will shortly be published. Watch for it; it will prove interesting to you.

TYPICAL AMATEUR HOOK-UP—COPY IT.

(168) G. W. Halberg, Chicago, Ill., writes:

Q. 1. Will you kindly give me a complete hook-up of the following apparatus: One 3,000 Meter loading inductance, one small mica condenser, one audiotron bulb, one loose coupler, one small Murdock fixt condenser, one pair of 2,000 ohm Headphones, one "A" Battery Rheostat, and one "B" Battery Rheostat, as well as complete "A" and "B" Batteries?

A. 1. A hook-up suitable for this apparatus appears on this page. In connection with this hook-up the average beginner should copy this and keep it in his scrap book, as it is one suitable for the general amateur who wishes to use a vacuum tube.

USING DAMPT OR UNDAMPT WAVES.

(169) H. W. Holmes, Sandersville, Ga., asks:

Q. 1. I wish to know which is the best wave to use in radio for the amateur, damp, or undamp?

A. 1. Altho the undamp wave is decidedly the best and will no doubt be the one used in the future, just at present, the most practical wave is the damp or spark signal method, and it is the one mostly employed by the general amateur. Undamp wave is also used to some extent by advanced amateurs.

LOOSE-COUPLER DIMENSIONS.

(170) G. S. Dozier, Stanford, Ky., writes:

Q. 1. I am about to construct a loose coupler and I wish to know the size of the magnet wire I should use for the primary and the secondary and what diameter each form should be?

A. 1. General dimensions for the average loose coupler are as follows, primary 6 inches long and 4 inches in diameter wound with No. 24 B. & S. single silk covered (green preferable), and the secondary should be 6 inches long and 3½ inches in diameter wound with No. 28 single silk covered wire.

THE ALMOST OBSOLETE FLEMING VALVE.

(171) Bernard G. Firth, Newark, New Jersey, writes:

Q. 1. Why have Fleming valves apparently gone out of use?

A. 1. The Fleming valve which consists of filament and plate only, does not permit

of fine regulation and control possible with the three element valve of the present day, in other words it is not very effective for radio work.

Q. 2. Can Fleming valves be bought and if so, where? Please show a detector circuit employing this valve.

A. 2. We suggest that you write to the Radio Corporation of America, 233 Broadway, New York City. They may be able to supply you. You may use any vacuum tube as a Fleming valve by connecting your instruments solely to the filament and plate, and overlooking the grid or third element. A simple Fleming valve detector circuit appears on this page.

TYPES OF HONEY-COMB COILS.

(172) F. W. Jones, Clatonia, Nebraska, asks:

Q. 1. What is the difference between the honeycomb coils and the Universal wound coils?

A. 1. There is no difference. The word "Universal" is merely a trade name.

Q. 2. What is the difference between the plain honeycomb coils and those that are tapt?

A. 2. The tapt ones merely give you a greater range of variable inductance, and it is therefore necessary to have a great number of additional coils of various sizes on hand.

LEAD-IN CONNECTOR.

(173) W. Hall, Newton Center, Iowa, wishes to know the following:

Q. 1. What is the best method of connecting the aerial wires to the lead-in without having to solder them? If possible show sketch of same.

A. 1. The best way to connect the aerial wires when it is not desired to solder them and therefore make the arrangement variable, and suitable for various experiments, etc., is by using an antenna wire connector. A typical one is shown herewith, and may be purchased at any reliable radio supply house. You may be able to construct this yourself with a small piece of brass providing you have drills and taps available.

TRANSMITTER HOOK-UP—COPY THIS ONE TOO.

(174) Theodore Taylor, Tarton, Mass., writes:

Q. 1. How much should a hot wire ammeter be graduated for a one inch spark coil?

A. 1. Up to about 2 amperes will answer quite well.

Q. 2. Where is N. A. H. 1? Sometimes I hear it signed without the "1."

A. 2. "NAH1" was formerly the station at Montauk, Long Island, but controlled at 44 Whitehall Street, New York City. In fact all NAH calls are controlled there.

Q. 3. Please publish a suitable hook-up for the following: Spark coil, key, spark gap, condenser, oscillation transformer, hot wire ammeter.

A. 3. A suitable hook-up is herewith published. It is suggested that beginners copy it in their notebook for future reference.

(Continued on page 650)

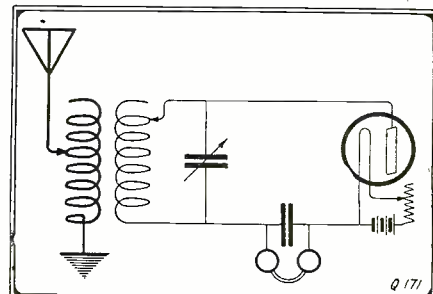

A Simple Two Element or Fleming Valve Detector Circuit.

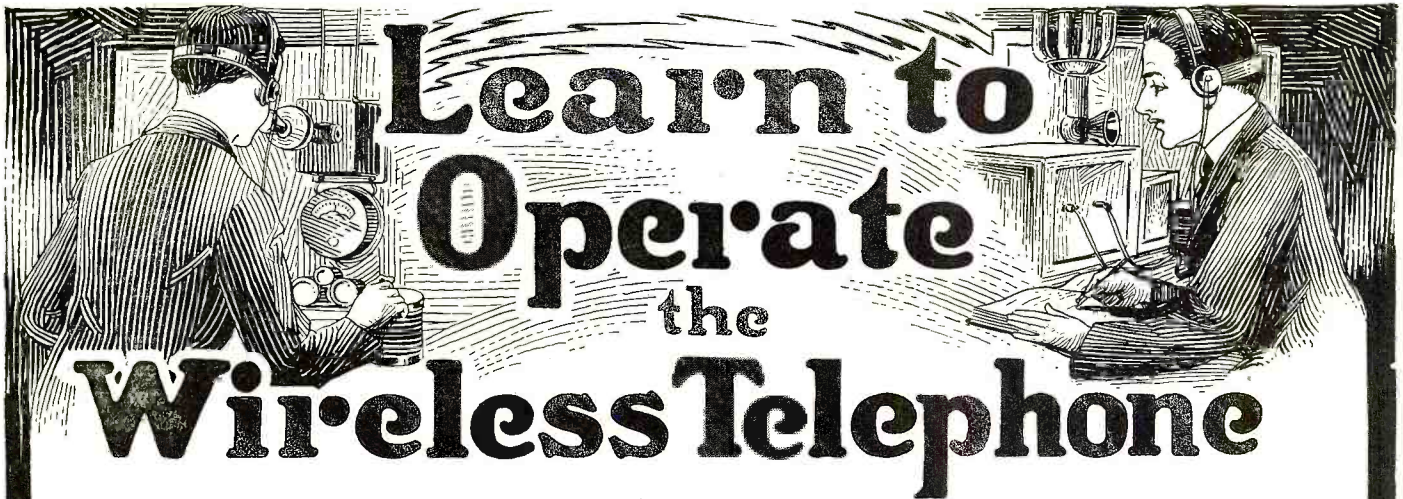

We Can Teach You Wireless Telephony At Your Home In a Few Weeks Through Our Special Home Study Course Which We Have Just Perfected.

FOR years the National Radio Institute, located in the Nation's Capital, the center of all official wireless activities, has held first place as America's foremost institute to successfully teach the various branches of the wireless profession. Our famous Home Study Course in wireless telegraphy has already helped men and women all over the world to master commercial wireless, secure their first grade license and hold big paying positions. Owing to the growing demand for experts in wireless telephony we now offer the first and original complete and thorough Home Study Course in Wireless Telephony. The successful completion of this course will enable you to hold a responsible position in the field of **commercial wireless telephony**.

Read These Facts About the Wonderful Development and Present Use of Wireless Telephony

Authorities state that wireless telephony will entirely supplant the present expensive system of telephone communication.

Wireless telephony makes possible telephonic communication with every section of the globe —on land, on water and in the air, thus practically annihilating space.

The steady and tremendous increase in the practical everyday use of wireless telephony by large industrial concerns, steamships and railroad companies, merchant marine, air mail service, army and navy, telephone and telegraph companies, governmental and diplomatic service, together with the recent organization of gigantic companies to manufacture and sell wireless telephone and telegraph apparatus, has opened up a tremendous field to ambitious men and women.

By taking up the study of wireless telephony now, as taught by the National Radio Institute, you will advance rapidly as its universal use increases and you will be carried along on the crest of the wave to success in what is fast becoming one of the foremost industries in the world.

Text Book and Advance Lesson On Approval

The National Radio Institute's home study course in modern wireless telephony consists of a complete text book containing 300 modern illustrations, a complete index and ten individual lessons, personal instruction and aid, each treating a practical phase of the subject, but depending on each other for a firm foundation and thorough knowledge of the entire subject. The real value of the course lies in the personal instruction, correction of lesson papers and individual help to suit each case. In order to quickly introduce the course we offer it complete for only \$15 cash or \$17.50 in payments of \$7.50 down and \$10 in thirty days. This enables you to examine the course before paying the full tuition. We will send the complete text book and first lesson on receipt of the attached coupon, properly filled out with \$7.50 on account. You may examine the text book and lesson for three days and may then remit an additional \$7.50 and we will send the remainder of the course in full; or you may remit an additional \$10 in thirty days; or return the text book and lesson in good condition within three days and your \$7.50 will be refunded to you.

The National Radio Institute
 Division of Radio Telephony, Dept. 204,
 Washington, D. C.

Send This Free Trial Coupon Today



THE NATIONAL RADIO INSTITUTE,
 Division of Radio Telephony,
 Dept. 204, 14th and U Sts., N. W., Washington, D. C.

Inclosed find deposit of \$7.50 on account for which send me prepaid your complete text book and lesson No. 1 of your Home Study Course in Modern Wireless Telephony for three days' examination on approval. At the end of three days I agree to either remit an additional \$7.50 in full payment of the entire course or to remit an additional \$10 in thirty days or return the text book and lesson to you in good condition within 3 days on receipt of which you will refund the inclosed \$7.50.

Name

Address

City..... State.....

LEARN WIRING!

EARN \$75. A WEEK

THIS YEAR'S EDITION WILL MAKE YOU AN EXPERT WIREMAN.

SEND FOR IT TO-DAY

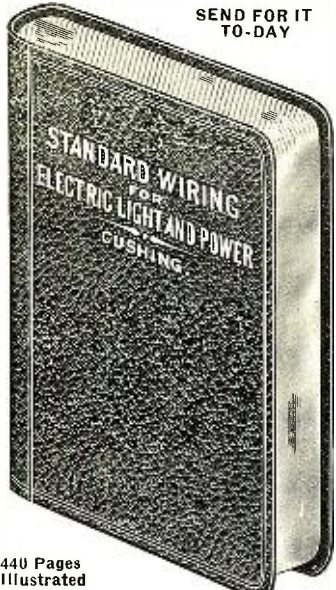

440 Pages Illustrated

The National Authority for 26 Years

All the latest underwriters' rules. 52 of the latest and simplest tables which show, at a glance, just what size of wire is needed for any kind and size of lighting or motor installation, for any voltage, current and drop desired for any system, Direct Current, Alternating Current, single, two or three-phase. How to install and operate generators, motors and every kind of wiring device with diagrams of connections.

Leather Cover. Pocket Size. Gift Edges. Sent Postpaid on Receipt of \$3.00.

H. C. CUSHING, JR.
14 W. 40th Street New York

CANADIAN AMATEURS:

This is our popular \$7.50 Loose Coupler. Made of the best material, mahogany finish. Wave length approx. 1,200 meters. Postage extra.



Send .05c for our code card and price list

By buying from a Canadian Firm Specializing in supplying Wireless Amateurs, you obtain the BEST SERVICE at the LOWEST COST.

LET US SERVE YOU

THE VIMY SUPPLY CO.

585 College Street TORONTO, ONT.

Compressed Air Motors

The New way of propelling your model aeroplane. Built of the finest materials. Guaranteed to be as represented or your money refunded. Engines and Model Aeroplanes built for you from your drawings at reasonable prices. Give us a trial and be convinced. Write for a circular of these wonderful motors. IT'S FREE.

HEC AEROPLANE CO.

345 E. 49th Street New York City

ARE YOU SELF-CONSCIOUS?

Embarrassed in company, lacking in self-control? Let us tell you how you can overcome these troubles.

THE VERITAS SCIENCE INSTITUTE

1400 Broadway DESK 24 New York

Found Via Radio

(Continued from page 611)

'phone conversation and replying with the key. I have had similar conversations with Toledo amateurs doing the sending vocally, while others replied to me by the key. My sending set is, however, not powerful enough to permit radiophone speech to be heard long distances.

I am now making arrangements to take an advanced course in radio engineering in a radio institute, as I intend to go forward with experimenting as my life work and will use the course as a stepping stone.

THE RESONANT CONVERTER TRANSMITTER.

A Correction.

Referring to Mr. Walter S. Lemmon's new transmitter described in April RADIO AMATEUR NEWS on pages 544 and 545, an error was made in the circuit diagram of Fig. 4, which is a complete hook-up of the Resonant Converter Transmitter. By consulting this figure it will be seen that there should have been a jumper between the first section of the transformer primary and the second section of the transformer primary, otherwise when the key is prest there would be no completed primary circuit and naturally nothing would happen when the 110 volt D. C. line was closed by the key. Please observe this diagram and make a mental or graphic correction when tracing connections.

ONE CENT A WORD FOR YOU

If you have a good true story to tell us about yourself and your station or any unusual radio occurrence or matter connected with radio, we want that story. We will pay one cent a word upon publication for all accepted stories. We desire you to feel that this new magazine is your magazine, and we will do all in our power to make it so. We want to make it as human as it is possible. Will you help?

RADIO TELEPHONE AT DAYTON, OHIO.

The amateurs of central Ohio have recently taken great pleasure in listening to the wireless telephone at McCook Field. This is a government flying field that is making tests on all kinds of aeroplanes and their equipment. We often hear them talking from the ground to an aeroplane in the air. They have a powerful set that is plainly audible here in the city on a galena detector. The sending range of their set is about one hundred miles taking in Cincinnati, Columbus and Indianapolis. On Friday nights they talk to the amateurs with the purpose of finding the range of their set. Upon hearing them any amateurs having transmitting sets are supposed to answer them by wireless telegraph and those that have not are requested to send in a post card to Radio Laboratories, McCook Field, Dayton, Ohio. They send on Friday nights between eight and ten o'clock on about two hundred to three hundred meters. Their call is M. C. F. Music is sent out with a Victrola and also by having people sing. The talking is not continuous as they frequently are obliged to stop and allow the apparatus to cool off. The present station is a temporary one but it is understood that in a few weeks a much more powerful station will be installed to operate permanently.

Contributed by WM. T. PRATHER.

Memorize Continental Code Almost Instantly

My Method is the Short Cut to Success

What They Say About It

Your chart just the thing for the beginner. I memorized the Code in two hours.

VERNON CORLISS,
Madison, Minn.

Your chart has filled the need of many an inexperienced wireless amateur. With its help I memorized the Code completely in one hour without any extra effort. Let me compliment you.

J. H. EISENBERG,
Brooklyn, N. Y.

Local addresses on request.

Complete chart and full instructions, TWO DIMES

C. K. DODGE

Mamaroneck, N. Y.



ELECTRIC Talking Machine

Never Wind It

stops itself when through playing. Fits any cabinet.

Electro Mechanical Parts Co.
160 N. Wells St., Chicago, Ill.

How to Become a WIRELESS OPERATOR

A practical book—boiled down to the real facts and giving all the information you need to become a Wireless Operator. No tiresome mathematics or useless data to wade through. 298 pages of interesting instruction and 186 pictures and diagrams that make difficult things as simple as A. B. C.

Money Back If You Want It

Send \$2.00 and 10c extra for mailing (stamps or money order) with your name and address. The book will come at once postpaid. Use it 5 days and send it back if you want to. Your money returned if you don't keep it.

AMERICAN TECHNICAL SOCIETY
Dept. W.S.-325 CHICAGO, ILL.

5 Days Trial

POPULARITY FOLLOWS THE UKULELE

If you play quaint, dreamy Hawaiian music or latest songs on the Ukulele you will be wanted everywhere. We teach by mail 20 simple lessons; give you free a genuine Hawaiian Ukulele, music, everything—no extras. Ask us to send the story of Hawaiian music. You will love it. No obligation—absolutely free.

The Hawaiian Institute of Music
1400 Broadway, Dept. 13E, New York

Learn Navigation by Mail

Hundreds of officers needed by big shipping companies and merchant marine. Captain Warren Sheppard, formerly instructor for U.S. Shipping Board, will tell you how to qualify.

SALARIES UP TO \$412 PER MO. AND EXPENSES

Write immediately for valuable free booklet, "Your Future is on the Seven Seas."

WORLD TECHNICAL INSTITUTE
Dept. 25, Fuller Bldg. Jersey City, N. J.

Amrad Radio Products

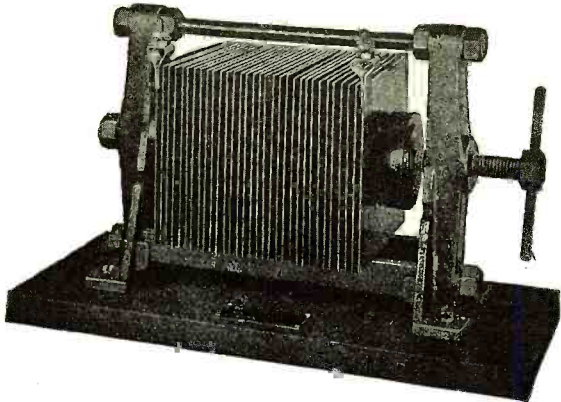

Amrad Quenched Gaps

"They report me painfully QSA" writes one user. "I am surprised at the radiation obtained on extreme low power consumption" says another. "Your sigs so loud it seemed almost unbelievable" said one postal from a station 500 miles distant. Instances like these, many times repeated, prove our claims for greater radiated energy, low decrement, reliability and economy—all on 60 cycles.

- Type G-1** 20,000 volts up, 1 K.W. \$26.50
- Type G-2** 10,000 volts up, ½ K.W. \$17.50
(Illustrated above)
- Type G-3** 5,000 volts up, ¼ K.W. \$12.50

Adjustable Resistances, necessary for obtaining highest efficiency and double frequency note, now available. Gaps and Resistances described in Bulletin Q.

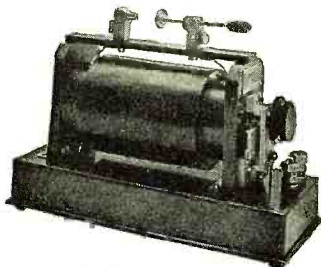

Amrad Induction Coil

The one and only coil on the market especially designed for radio work. Rating 100 watts. Output 100% greater than the average 2" coil. Puts the "punch" into the antenna.

- Type C** 6 volt primary \$28.50
- Type C-1** 32 volt primary \$29.50
- Either coil in combination with TYPE G-3 Gap, special short-time price \$33.50

Bulletin P gives complete information.

Catalog and bulletins for insertion therein sent on request. All licensed radio operators stating station call letters and giving name of nearest radio dealer will be placed on our regular mailing list to receive new bulletins as fast as issued.



Range
130-230
Meters

Price
\$6.50

Amrad Wavemeter, Type D

Shows your wavelength directly in meters. No calculations. Accurate. Set plumb on 200 meter mark when calibrated. All other readings within 2% accuracy. A great aid when tuning up Quenched Gap sets. Useful also for determining antenna wavelength and calibrating receiving sets. Ask for Bulletin W.

Type
C



Price
\$4.50

Amrad Detector Stand

Improved construction. Moulded Electro-se base. Compact, rugged, neat. Sensitive adjustment, remarkably proof against shock. Tested and approved by Navy Department. Single model, Type C-1, \$2.50. Bulletin T describes.

Type
B



Price
\$9.85

Amrad Lighting Switch

A standard 100 ampere switch mounted on three 40,000 volt insulators. Leakage common to ordinary slate base switches totally eliminated. Insure the safety of your home and station and increase your transmitting efficiency by installing this switch. Meets Fire Underwriters' specifications.

AMERICAN RADIO AND RESEARCH CORPORATION

15 Park Row
New York

Address all Communications to New York
Prices subject to change without notice.

Factory and Laboratory,
Medford Hillside, Mass.

UTTMARK'S NAUTICAL ACADEMY and RADIO INSTITUTE

Capt. F. E. Uttmark, Principal

ESTABLISHED 1804

We offer you a complete course in Radio Telegraphy, tutored by experienced and competent instructors. Here you learn to become a practical wireless operator, and a position for you is guaranteed as soon as

you qualify. There are day and evening classes, and you may start any day or evening convenient to yourself. We have installed in our school the latest transmitters and receivers as used commercially today.

SEND FOR PROSPECTUS—OPEN ALL YEAR

UTTMARK'S RADIO INSTITUTE

8 State Street, New York City

Phone: Bowling Green 8079

Another



Achievement

The Grebe Special Type CR-3 Relay Receiver



Unparalleled performance on Relay wavelengths.

Constructed according to the highest engineering and manufacturing standards.

This Instrument was fully described in Q S T for March, 1920, and may be found on display by the following concerns:

- DOUBLEDAY-HILL ELECTRIC CO., Pittsburgh, Pa.
- HOLT ELECTRIC UTILITIES CO., Jacksonville, Fla.
- MANHATTAN ELECTRICAL SUPPLY CO., New York, Chicago, St. Louis.
- PACENT ELECTRIC CO., Inc., New York City.
- GEO. W. PAREZO & CO., Washington, D. C.
- F. D. PITTS CO., Inc., Boston, Mass.

A. H. GREBE & CO., Inc., 72 Van Wyck Blvd., Richmond Hill, N. Y.

A REAL TELEPHONE

Guaranteed to work on two batteries a distance of 200 feet — price per set as shown, **\$ 1.50** including diagrams

Postpaid

TRANSMITTERS or RECEIVERS **\$ 1.00** ONLY 30 Cents each, or four for

Postpaid

Catalogue for Stamp

INLAND SPECIALTY CO.

1562A N. ROBEY ST.

CHICAGO, ILL.

The Audio Oscillator

(Continued from page 614)

Each transformer core has a small air gap to prevent distortion of the wave form. Since, however, the magnetic circuits are all nearly closed iron paths there is very little outside field. This feature is particularly important where the oscillator is being used in close proximity to the bridge. The tuning fork insures that the frequency be kept constant and at 1000 cycles. The resonance circuit is carefully adjusted to this value. Since the oscillator is self-starting it may be located at a point distant from the bridge and operated by a switch placed at the bridge.

By the use of the field magnetizing coil on one tine of the vibrating fork, instead of relying on its permanent magnetism, the polarity and intensity of the magnetization of the fork with respect to the armature are permanently maintained.

Success or failure in the operation of a hummer, or audio oscillator, lies very largely in the microphone button. If the button heats so that the oscillator cannot be run indefinitely, if the adjustment of the button is not permanent, or if slight mechanical shocks change its operating characteristics the oscillator has little commercial value. A distortion of as small an amount as one five-hundredth of an inch from normal mica will destroy the perfect operation of the button. In order that the button may be insensitive to mechanical shocks and yet operate properly at 1000 cycles, use is made of its high inertia effect at the latter frequency. One side of the button is attached to the tuning fork by means of a short, flat spring. The other side, which has a projecting mounting post, is held in position by a specially designed self centering spring. This combination of springs enables the button to withstand severe shocks, yet it has sufficient inertia so that perfect operation is obtained. The adjustment of the button is permanent and needs no further attention after leaving our laboratory. This type of mounting, together with the fact that the electrical constants of the circuits have been adjusted to their optimum values, insures the continuous operation of the oscillator without heating.

The oscillator is mounted in a polished oak box and has an engraved bakelite panel. The exposed metal parts are finish in polished nickel. The control switch is easily accessible and is of the convenient lock button design.

AN ARLINGTON TUNER FOR \$1.50!

I bought three rolls of annunciator wire, each roll containing a pound of wire. I wound some tape around two of them to prevent loosening of the turns. One of these two I used as a primary and the other as secondary. From the third roll I unwound about 1/3 of the wire and around the remainder I wound tape as I did on the other two. This coil I used as a tickler. Using these coils in the same manner as honeycombs, with an .001 condenser across the primary and secondary, Arlington is heard about twenty feet from the phones. Due to the heavy insulation between turns, and layers, the distributed capacity is reduced to a minimum. I used the ordinary tickler feed-back circuit.

Contributed by EDWARD MAGED.

PHOTOGRAPH CORRECTION.

Credit should have been given to Mr. S. Cohen, who kindly furnished the photographs which appeared in the article entitled "New Radio Apparatus" in the March RADIO AMATEUR NEWS, on page 467.

RADIO APPARATUS

Distributors of Reliable Radio Apparatus for Experimenters in every branch of the Radio Field

“PITTS CO” THE SIGN OF SERVICE AND IMMEDIATE DELIVERIES! ALL WE ASK IS A TRIAL!



REMEMBER WE CARRY AN IMMENSE STOCK AND CAN MAKE IMMEDIATE DELIVERY ON EVERY ITEM LISTED.

LOADING INDUCTANCES
 No. 510 Murdock, 3000 meters.....\$4.00
 No. Y-901 Clapp Eastham, 1500 meters. \$4.00
 F. D. PITTS CO., BOSTON, MASS.

INDUCTION COILS
 No. 7758 Mascot 3/4 inch.....\$ 3.60
 No. 7759 Mascot 1/2 inch.....\$ 4.50
 No. 7761 Mascot 1 inch.....\$ 6.95
 No. 7763 Mascot 2 inches.....\$13.55
 F. D. PITTS CO., BOSTON, MASS.

INSULATORS (Lead-in)
 No. 8685 Electrosc, 4 9/16 x 2 inch lead-in insulator with 1/4 in. wire hole. \$1.60
 No. 8686 Similar to 8685, but 9/16 x 2 inch, with 3/4 inch rod.....\$2.10
 No. 8687 Electrosc 5 7/8 inch lead-in insulator, with 3/8 inch wire hole.....\$2.75
 No. 8688 Similar to 8687, but 6 1/4 inches with 3/8 inch rod.....\$3.25
 F. D. PITTS CO., BOSTON, MASS.

INSULATORS (Antenna)
 No. 0-2 4 inch antenna insulator.....\$0.50
 No. 0-3 10 inch antenna insulator.....\$1.00
 No. 0-4 16 inch antenna insulator.....\$1.50
 No. 0-5 22 inch antenna insulator.....\$2.45
 No. 0-6 3 inch porcelain strain insulator. \$0.15
 No. 0-7 5 inch hard rubber antenna insulator.....\$0.28
 No. 0-8 10 inch hard rubber antenna insulator.....\$0.57
 F. D. PITTS CO., BOSTON, MASS.

KEYS
 No. 285 Murdock (strap key).....\$0.70
 No. 7913 Beeko practice key.....\$1.50
 No. 8650 Mascot, up to 1/2 K. W.....\$2.95
 No. 7939 Standard, up to 1 K. W.....\$3.75
 No. B-100 Bowman, up to 2 K. W.....\$5.95
 No. Y-643 Clapp Eastham, up to 10 amperes.....\$7.50
 F. D. PITTS CO., BOSTON, MASS.

LOOSE COUPLERS
 No. R-1 Radio Apparatus Co., 3500 meters.....\$27.50
 No. 5 Arnold, 3500 meters.....\$20.00
 No. Y-673 Clapp Eastham Radion, 3000 meters.....\$14.00
 No. 344 Murdock, 1500 meters.....\$ 9.00
 No. RKAB Grebe variometer coupler.....\$21.00
 F. D. PITTS CO., BOSTON, MASS.

OMNIGRAPHS
 No. 2 Omnigraph, complete with 15 dials.....\$28.00
 No. 2-A Omnigraph Jr., complete with 5 dials.....\$20.00
 No. 5 Omnigraph, complete with one dial.....\$12.00
 Extra dials for No. 2 and 2-A.....each \$.20
 Extra dials for No. 5.....each \$.10
 F. D. PITTS CO., BOSTON, MASS.

REGENERATIVE RECEIVERS
 No. CR-1 Grebe, 170 to 600 meters with tube control.....\$100.00
 No. CR-2 Grebe, 170 to 600 meters..\$ 46.00
 No. CR-3 Grebe, 170 to 600 meters (new type just out).....\$ 60.00
 No. CR-4 Grebe, 170 to 600 meters (with series condenser).....\$ 65.00
 No. CR-6 Grebe, 170 to 600 meters with detector and 2 step amplifier self contained.....\$180.00
 No. CR-7 Grebe, 500 to 20000 meters long wave receiver.....\$210.00
 Note:—Each receiver is a creation in workmanship and performance.
 F. D. PITTS CO., BOSTON, MASS.

SPARK GAPS
 No. 7750 Beeko, zinc points.....\$1.10
 No. 7751 Mascot, zinc points large, up to 1 K. W.....\$2.50
 No. 440 Murdock, zinc points.....\$.90
 No. Y-656 Clapp Eastham, large, up to 1 K. W.....\$4.50
 F. D. PITTS CO., BOSTON, MASS.

SPARK GAPS (Rotary)
 No. 443 Murdock, R. P. M. 4000.....\$15.00
 No. K-1 Klitzner, R. P. M.....\$22.00
 F. D. PITTS CO., BOSTON, MASS.

TELEPHONES (Pair)
 No. 1 Type C Baldwins, standard Navy type.....\$16.50
 No. 2 Type E Baldwins, new type, smaller.....\$18.50
 Brandes, “Superior” 2000 ohms.....\$ 7.00
 Brandes, “Transatlantic” 2800 ohms...\$10.00
 Brandes, “Navy type” 3200 ohms.....\$14.00
 No. 55 Murdock, 2000 ohms.....\$ 4.50
 No. 55 Murdock, 3000 ohms.....\$ 5.50
 No. CW-834 Western Electric, 2200 ohms.....\$12.50
 F. D. PITTS CO., BOSTON, MASS.

TRANSFORMERS (Sending)
 No. D-1 Acme 1/4 K. W. sec. volt. 6000.....\$19.00
 No. F-1 Acme 1/2 K. W. sec. volt. 9000.....\$25.00
 No. H-1 Acme 1 K. W. sec. volt. 12000.....\$38.00
 No. T-1 Thordarson, 1/4 K. W.....\$17.00
 No. T-2 Thordarson, 1/2 K. W.....\$27.00
 No. T-3 Thordarson, 1 K. W.....\$45.00
 F. D. PITTS CO., BOSTON, MASS.

TRANSFORMERS (Oscillation)
 No. 424 Murdock.....\$ 5.00
 No. Y-100 Clapp Eastham.....\$14.00
 No. Y-200 Clapp Eastham, large, for 1 K. W.....\$20.00
 F. D. PITTS CO., BOSTON, MASS.

TUNING COILS
 No. 8995 Mascot receiving set, complete, consisting of Mascot tuner, Jove detector fixed condenser, receiver, cord and crystal.....\$10.50
 No. 8996 Same as 8995, less receiver and cord.....\$ 8.95
 No. B-1 Bowman 2 slide tuner, 1500 meters.....\$ 3.75
 No. 240 Murdock 2 slide tuner.....\$ 4.00
 F. D. PITTS CO., BOSTON, MASS.

VACUUM TUBES
 No. VT Marconi, class 1 detector.....\$7.00
 No. VT Marconi, class 2 Amplifier.....\$7.00
 F. D. PITTS CO., BOSTON, MASS.

WAVEMETERS
 No. A-6 Amrad, Special for amateurs..\$ 6.50
 No. Z-7042 Clapp Eastham, 150-2000 meters.....\$27.50
 No. 132-A General Radio, Portable, 150-2600 meters.....\$29.00
 F. D. PITTS CO., BOSTON, MASS.

BOOKS
 Practical Wireless Telegraphy, by Bucher.....\$2.25
 Vacuum Tubes in Wireless Communication, by Bucher.....\$2.25
 Wireless Experimenters Manual, by Bucher.....\$2.25
 Radio Telephony, by Goldsmith.....\$2.25
 Consolidated Radio call book.....\$1.00
 F. D. PITTS CO., BOSTON, MASS.

Important! Every article listed sent to any part of the United States postage prepaid or express prepaid. We want your business!

Series No. 2 (Keep this page and watch for next month's)
SEND 6 CENTS IN STAMPS FOR NEW CATALOG!

F. D. PITTS CO., Inc.

12 Park Square

Dept. C.

Boston, 11, Mass., U.S.A.

A UNIQUE INSTRUMENT



THE ROLLER-SMITH "V-A-W"

Radio Frequency Ammeter simplifies your measuring instrument problem because it can be used equally on

Radio Frequency Current Audio Frequency Current Direct Current

It's furnished in either flush or surface mounting, with ranges as high as 0-5 amperes, at attractive prices.

Write for Booklet "V-TAW"



Main Office: 15 Barclay Street,
New York, N. Y.

Works: Bethlehem, Pennsylvania

CHICAGO—Monadnock Block
CLEVELAND—Williamson Bldg.
DETROIT—Vickers Bldg.
Other Offices in Principal Cities

Here is the very

high-tension circuit standard for whose advent the better class of amateurs have long waited.

It is made of a 7" "Electrose" standard—with polished brass base and copper clip for holding 1/4 or 5/16" O. D. tubing (other size clips 10c extra).

No. 6500. Standard—plain base, \$2.60.

Exceptional quality. Order one today, money and transportation charges refunded if not satisfied.

Toledo Radio Specialties Company
P. O. Box 343, Central Station, Toledo, O.

You can be quickly cured, if you STAMMER

Send 10 cents coin or stamps for 70-page book on Stammering and Stuttering, "Its Cause and Cure." It tells how I cured myself after stammering for 20 years.
Benjamin N. Bogue, 858 Bogue Bldg., Indianapolis

Fading Signals

(Continued from page 621)

may say that there are no potential nodes, that the waves travel out similar to ocean waves, but this is only a theory and has no experimental proof.

We can clearly see now that if a receiving station happens to be located at any of these potential nodes as at B-D-F, etc., it cannot respond to the sending station. A receiving station located between the potential nodes can respond to the sending station, the maximum response being obtained at the current nodes, as at C-E-G. It is obvious then that a station at D cannot hear station A, whereas a station at G can hear station A, altho station G is farther away from station A than station D is.

The fading away of signals is due to slight variations in the wave length of the incoming wave. A very slight change in the wave length will shift all the potential nodes either to the right or to the left. Station D will then be able to hear station A. A further change in wave length may shift the potential nodes back to their original position. Then station D will not be able to hear station A. This is actually what happens with a 200 meter wave. The gradual change of an undamped 200 meter wave is very noticeable when using the heterodyne or beat method of reception.

A more frequent occurrence of fading signals among the amateur stations than among the commercial stations is to be expected. The amateur wave length of 200 meters has a potential node every 100 meters, whereas the commercial wave lengths have nodes spaced from 300 to 10,000 meters. The chances are therefore very remote that a receiving station will be located on one of these nodes.

In order to control this fading phenomenon it will be necessary to make gradual changes in the wave length and hold the wave constant at any value. In this way we could shift the current and potential nodes so as to obtain maximum efficiency between two given stations. Perhaps a small variometer inserted in the antenna circuit of the sending station will do the trick. The variometer can be small, say two turns of wire, as a small change in the wave length will shift the nodes a considerable distance. The experiment may prove of great value, and should be tried on all the amateur stations.

WASHINGTON RADIO AMATEURS HEAR RADIO CONCERT.

Recent development of radio telephony at a Washington, D. C., experiment station here has reached the stage where thirty amateurs on the receiving ends of wireless apparatus throughout the city reported that they hear musical records being played at the Bureau of Standards Radio Research Laboratory. F. W. Fennimore of the Bureau of Standards has been aiding in the development of the radio telephone for several weeks, but experiments did not reach the stage of perfection which allowed a general reception of a musical program until several nights ago. Mr. Fennimore called up his wife by radiophone at about 9 p. m. She replied that she was entertaining company, and requested that a musical number be put on by radio. According to reports the music was heard well enough to dance with at the Fennimore home. Shortly after the record was sent out, thirty calls from amateurs throughout the city announced that they were listening in and "getting it."

Special While they last, regular \$10.00 General Radio radiation meters; range 0-2 and 0-2 1/2 amps **\$5.00**



The ORIGINAL AUDIOTRON ADAPTOR

Consists of a standard 4 prong base with appropriately placed brass pillars to accommodate five leads. Practical and convenient.

\$1.75 EACH Postpaid Pat. Applied For

New "VT" Socket, \$1.00

One look convinces you our Paragon Filament Rheostat is the best. The 6 ohm non-oxidizing resistance, permits fine adjustment on 4 or 6 volts. Cast in heat-proof Condensite 2 1/2" dia. for back or front mounting.

\$1.75 Each, Postpaid

RADIO EQUIPMENT CO.
630 WASHINGTON ST. BOSTON, MASS.



LEARNERS KEY AND BUZZER SET \$1.50

Key made of solid brass, with screw adjustments.

Buzzer has pure silver contacts. Brass terminals.

Key unmounted, 75 cts. Buzzers, 35 cts.

Send to

AJAX ELECTRIC CO.

Newberne St. Somerville, 44, Mass.

FREE **POCKET HANDBOOK and CATALOGUE**

Radio Handbook & Catalogue

Contains much valuable radio information, tables and data. Describes a remarkable line of wireless instruments including "Red Head" Phones, Arlington Tested Minerals, DeForest, Murdock and Signal Apparatus. Write for this book today.

The Newman-Stern Co.
Dept. R. N. Cleveland, O.

Red Head Radio Phone

The accepted standard in wireless receivers. If they are not BETTER than anything you've ever seen return them for full cash refund. Our Radio Handy Book and Catalogue, free on request, describes them, and many other instruments.

The Newman-Stern Co.
Dept. R. N. Cleveland, O.

\$7.00

ARLINGTON TESTED CRYSTALS

Why buy minerals on a gamble? Be SURE when you put a crystal in your detector or that it is EXQUISITELY SENSITIVE. Buy Arlington individually tested Minerals. Galena or Silicon, post paid on receipt of price.

35c

THE NEWMAN-STERM CO.
Dept. R. N. Cleveland, O.

The "SHIMMIE DANCER"

"See Minnie shimmy boys, its great fun." A picture of lady in bathing costume. By pressing back, the figure "Shimmies." Picture is oval, 2 1/2" long, with beautiful silver frame.

Price Only 25c

Beehive Sales Co., 4103 N. Crawford, Chicago

30 DAY SPECIAL OFFER

The **WIRELESS EXPERIMENTERS MANUAL** Price \$2.25 (E. E. Bucher's New Book) and one year's subscription to **THE WIRELESS AGE \$2.00**

Both for only \$3.75

Wireless Press
326R Broadway
New York City

Postage outside U. S. 50c ext. a. Send for catalog.

LEARN WIRELESS AT HOME

The Demand for Wireless Operators Far Exceeds the Supply

The New York Wireless Institute will make you an operator—AT HOME—in your spare time—quickly, easily and thoroughly. No previous training or experience required. Our Home Study Course has been prepared by Radio Experts. Experts able to impart their practical and technical knowledge to YOU in an *easy to understand* way. The graded lessons mailed you will prove so fascinating that you will be eager for the next one. The instruments furnished *free*, will make it as easy to learn the Code as it was to learn to talk. *All you will have to do*, is to listen.

Big Salaries

Wireless operators receive excellent salaries ranging from \$125 to \$200 a month and it is only a stepping stone to better positions. There is practically no limit to your earning power. Men who but yesterday were Wireless Operators are now holding positions as Radio Engineers, Radio Inspectors, Radio Salesmen at salaries up to \$5000 a year.

Travel the World Over

A Wireless Operator can visit all parts of the world and receive fine pay and maintenance at the same time. Do you prefer a steady position without travel? There are many opportunities at the numerous land stations or with the Commercial Wireless or with the Steamship Companies.

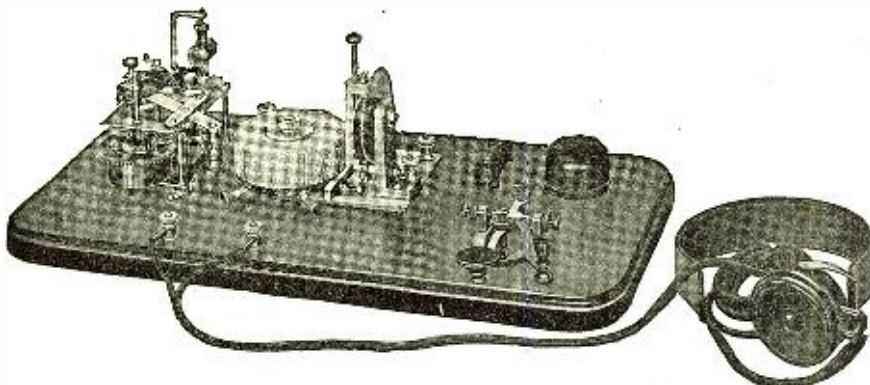

This wonderful Set for learning the Code furnished free with our Course

FREE Instruments and Text Books

We furnish free to all students, during the course, the wonderful receiving and sending set exactly as produced in the illustration. This set is not loaned, but given to all students completing the Course.

The Transmitter shown is the celebrated *Omnigraph* used by several Departments of the U. S. Government and by the leading Universities, Colleges, Technical and Telegraph Schools throughout the U. S. and Canada. Start the *Omnigraph*, place the phone to your ear and this remarkable invention will send you Wireless Messages, the same as though you were receiving them, through the air, from a Wireless Station hundreds of miles away. When you apply for your license, the U. S. Government will test you with the *Omnigraph*—the same model *Omnigraph* as we furnish to our students. Ask any U. S. Radio Inspector to verify this.

Easy Payments

A small payment down will enroll you. We will make the payments so easy that anyone ambitious to enter the fastest growing profession—Wireless—may do so.

Send for FREE Booklet

Without obligating you in any way, send for our booklet "How to Become an Expert Wireless Operator"—it is free. Mail the coupon below, or postal or letter—but do it today.

NEW YORK WIRELESS INSTITUTE

Dept. 22, 258 Broadway, New York City

New York Wireless Institute
Dept. 22, 258 B'way, N. Y. City

Send me free of charge, your booklet "How to Become an Expert Wireless Operator," containing full particulars of your Course, including your *Free Instrument Offer*.

Name

Address

City or Town.....State.....

FREE Post-Graduate Course

A one month's Post-Graduate Course, if you so desire, at one of the largest Wireless Schools in N. Y. City. New York—the Wonder City—the largest port in the World and the Headquarters of every leading Wireless and Steamship Company.

Make Your Own WIRELESS APPARATUS



SAVE 1/2

It's easy to make your own at home with the aid of these 4 up-to-date books that you can understand. Each has over 72 pages and over 60 illustrations. 3 color cover, size 5x7 inches.

LESSONS IN WIRELESS TELEGRAPHY is a course in the elementary principles which you must understand to obtain good results.

WIRELESS CONSTRUCTION AND INSTALLATION FOR BEGINNERS gives complete details with working drawings for making simple but good sending and receiving apparatus and erecting aeriels, etc.

THE OPERATION OF WIRELESS TELEGRAPH APPARATUS shows how to obtain best results and greatest ranges with all kinds of apparatus, how to tune the station to 200 meters, use a wave meter, apply for license, etc.

EXPERIMENTAL WIRELESS CONSTRUCTION gives details, with working drawings for making more elaborate and efficient sending and receiving apparatus, complete sets, etc.

35c Each Any Postpaid THREE \$1.00

GET THEM NOW
PRICE MAY ADVANCE ANY DAY

COLE & MORGAN, Inc., Publishers
Dept. 132, 19 Park Place, New York

Do You Know

that you can get large discounts on all instruments made by joining

THE CO-OPERATIVE RADIO ASSOCIATION?

Every member gets the discount in the form of credit memos, which are sent to him together with the merchandise ordered. This amounts to a large saving which you should not overlook.

The nominal fee for becoming a privileged member is ten cents. Send your dime today and get the benefits of the large purchasing power of the association.

Write to

THE CO-OPERATIVE RADIO ASSOCIATION

349 Freeman St. New York City

Send Us a Stamped Self-Addressed Envelope for Important Information on

Radiophones and Wave-Meters

AND DATA AND PRICES ON HONEYCOMB COIL ADAPTORS—Which Fit the DeForest Plus Inductances to Variable Condensers. Back-Mounted Bakelite "VT" Sockets, \$1.

Somerville Radio Laboratory
102 Heath Street, Somerville—45, Mass.

ADVERTISING PAYS

It pays the man who advertises and it pays the man who answers ads. For advertising rates in the E. E. address Advertising Dept., 233 Fulton St., N. Y.

Mars Refuses To Answer

A Wave Length of 300,000 Meters
Tried to no Avail

Nary a sound from neighbor Mars came over what was probably one of the most sensitive and long range receiving sets ever constructed to reward an all night listening-in vigil by two enthusiastic experimenters of Omaha, Nebraska.

With an instrument so sensitive that without any antenna whatever it copied a message from Arlington, and with thirty miles of wire hooked up to it and a wave length of 50,000 meters, Dr. Frederick H. Millener of Omaha and Harvey Gaimer, electrical expert, listened for hours for anything that might be construed as a signal from the planet, but heard nothing. April 22 was chosen for the experiment, because Mars was closer to the earth than it will approach again in several years. The listening will be continued for some time however.

"The wave length carried us entirely outside of any sound on the earth," said Dr. Millener, "and if there had been anything going on out there we certainly should have heard it. We heard absolutely nothing."

The experiment was dramatic, nevertheless. The operators began listening about 8 o'clock. At first they used wave lengths of 15,000 to 18,000 meters.

"For several hours it seemed as if we heard everything that was going on in the world," said Dr. Millener. "We got Berlin, Mexico and all the large stations. The static was very bad. We got in on a thunderstorm somewhere, and the crackling of the lightning was like hailstones on a tin roof all around us.

"About 2 o'clock it cleared up and everything was quiet. We got the time from California. Then we hitched up the long wave length. That took us out into space beyond anything that might be taking place on earth.

"There was the most deathly silence.

"We concentrated our faculties to catch the faintest sound, but there was nothing; nor was the silence broken, even by static, during the entire time that we had the long wave length hooked on."

For hours Dr. Millener varied the inductance from a wave of 1,000-meter length to one of 300,000, but in all that distance no sound was heard. Below the 18,000-meter mark all sorts of messages were picked up.

Concerning the extraordinary wave length of 300,000 meters a very interesting editorial appeared in the February issue of *R.A.N.* by the Editor, where he suggested to our contemporary radio engineers, investigation similar to the present one, and where he predicted that if there were any "extra-terrestrial messages" floating around trying to find an ear or two willing to listen this little ball of ours would soon confirm the fact *beaucoup* too sweet.

REAL MONEY WAITING FOR YOU.

The editors of RADIO AMATEUR NEWS are holding checks for the following named contributors owing to the fact that they failed to send us a proper address with their manuscripts. Let us hear from you, young men, and "come across" with a proper local address. Here are the names:

Ray T. Foster
James Miller
Chas. H. Kressler
D. K. Vanneman, Baltimore, Md.
William H. Davis, Baltimore, Md.
John H. Peth
Elmore Spicer
H. E. Parsons
Chas. Sear, St. Louis, Mo.

Remember—full name, street and number, and name of city or town.



INDICATING DIALS

Of polished hard rubber, accurately engraved, filled with brilliant white, furnished complete with knob, shaft, tension spring and nuts ready for panel mounting.

"The Best"

3" DIAM. { 180° scale 0-100 } \$1.50
 { 90° scale 0-50 } POSTPAID

2" DIAM. { 180° scale 0-100 } \$1.25
 { 90° scale 0-50 } POSTPAID
 "Increase"

Five cents brings you our loose leaf catalog and puts your name on our mailing list. Write now.

THE WILCOX LABORATORIES
LANSING DEPT. C MICHIGAN

MERACO

Perfect "B" Batteries

Standard BA-2 TYPE, the same as used by U. S. Army & Navy Signal Corps.

Fully guaranteed on a money back basis. Order by Catalog Number.

Cat. No.	Volts.	Price.
BA-2-xpr-1K	22.5	\$1.20 postpaid
BA-2-xpr-2	22.5	\$2.20 postpaid
BA-2-xpr-3	45.	\$4.75 postpaid

Watch this Magazine for future advertisements.

Mercury Radio Appliance Co.
Dept. B-1, 672 Broadway, Brooklyn, N. Y.

Amateurs Please Read the Following!

We are distributors of all prominent HIGH GRADE Radio Apparatus, throughout the middle states. It is our desire to satisfy our customers, we therefore solicit your patronage. A trial will convince you. Write us your needs. Are you interested in solderless terminals?

Send 5 cents in stamps for latest Bulletins

CHICAGO ELECTRICAL ENGINEERING CO.

1000 Diversey Parkway
Radio Dept. Chicago, Illinois



VACUUM TUBE CONTROL PANEL

Most efficient and neatest panel manufactured.

Bakelite panel, graduated dials, mounted in oak cabinet. Variable grid condenser, rheostat, and tube receptacle mounted back of panel.

May be used in any circuit.

PRICE-less Bulb (with V.T. Base or Audiotron mounting)—\$15.00

For Full information write

DAYNOR RADIO ELECTRIC COMPANY
Box 105 Wilkingsburg, Pa.

20,000 METER TUNER! \$15
Tuners, Cabinets, Condensers, Rheostats, Binding Posts, etc. All first-grade stock. Get all the data, boys, Free. Just write.

"ARK" RADIO SUPPLY
97 Hill Street, Shelton, Conn.

WINN HI-QUALITY Wireless Apparatus

**WINN Portable Wireless Set
No. 149
\$50.00**



WINN PORTABLE WIRELESS SET

This SET represents the very highest type of construction throughout, made complete in our own factory, of excellent materials, by expert workmen, under the direct supervision of R. E. Winn. Each part carefully tested to insure absolute reliability and dependability under all conditions of service in home station or field. Size of box 8x9x11, handsome mahogany finish, all metal parts heavily nickel plated, weight 16 lbs., handy carrying strap of heavy ribbed duck.

Sending Range 10 to 12 Miles

Receiving range 200 to 300 miles under favorable conditions. Lightest portable set made of equal high quality. Offers amateurs and professionals a well made, beautifully finished, compact, and efficient Wireless Set, which anyone would be proud to own and use. Particularly well adapted to Boy Scout organizations. Scouts in camp, on the hike or at home, could keep in touch with other camps as well as the outside world. No special aerials required. Complete instructions with binding guarantee enclosed in each box, the guarantee an insurance of satisfaction. Price complete with phones, \$50.

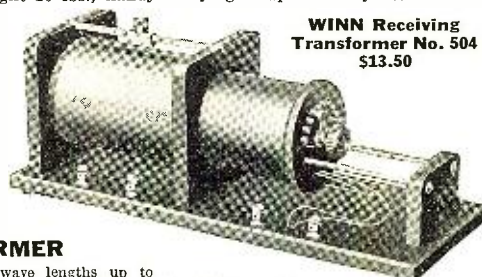

**WINN Receiving Transformer No. 504
\$13.50**

WINN RECEIVING TRANSFORMER

This instrument gives good results receiving wave lengths up to twenty-five hundred meters. To simplify the use of transformer for beginners, this one is to be used in place of tuning coil and tuning inductances, where distances and sharper tuning is required. The aerials in ground are connected with the two binding posts below the primary. The secondary terminals connect with the two remaining binding posts. Contact is made by means of a slider mounted conveniently on top of the primary. All metal parts heavily nicked. Base and end pieces of birch highly polished. Price \$13.50.

WINN TRANSMITTER COIL

This coil is especially designed for wireless and high frequency work. Produces heavy, energetic spark. Capable of transmitting up to 25 miles under favorable conditions. Contact points on Interrupter extra large, of heavy platinum iridium. Interrupter is our own Winn design, and the most sensitive vibrator made. Transmitter complete with exception of Spark Gap and Key. Normal voltage required 10 to 12 volts, although higher voltage may be used. Mounted in mahogany finished cabinet, with nickel plated mountings. Price \$7.50.



WINN Detector No. 400, \$5

WINN DETECTOR No. 400, \$5

Our Detector is in a class by itself and is the outcome of long and careful experiments to produce an article which does away with all the objections of the ordinary Detector. Enclosed in glass, dust-proof cylinder, which keeps the mineral clean and free from vibrations. This feature alone bears out our claim for general excellence of any and all WINN apparatus.



**WINN Transmitter Coil No. 201
\$7.50**

Your dealer will supply you with any WINN HI-QUALITY Wireless Apparatus. If not, send his name and we will see you are supplied promptly. Write for our "Supplement A" advance catalog, which contains complete information about the entire WINN HI-QUALITY Radio goods, a valuable book for amateur or professional Wireless workers. FREE to you.

WINN RADIO & ELECTRIC MFG. CO. 537 SOUTH DEARBORN ST., Dept. 11, Chicago, Ill.

LICENSED BY DE FOREST AUDIOTRON

The Original Tubular Vacuum Amplifier

The AudioTron Vacuum Tube is now manufactured and sold as a genuine audion licensed under DeForest Patents Nos. 841387 and 879532 to be used only for amplification in radio communication and only for experimental and amateur purposes and only in audio frequency circuits.

The AudioTron has a double filament of special thorium tungsten and the operating life is over 2,000 hours. No special socket is required. The electrical and mechanical dimensions result in a heavy plate current and corresponding signal strength. Plate voltage under 40. Our guarantee insures satisfaction.

PRICE \$6.00 EACH

If your local dealer cannot supply you we will ship postpaid when cash accompanies order.

The AudioTron Exclusive Guaranty: Each and every AudioTron is guaranteed to arrive in good condition and to prove fully satisfactory. Replacement of unsatisfactory tubes will be made free of charge.

AudioTron Audio-Frequency Transformer \$7.00
Laminated closed core, two coil type.

DEALERS:—Write for our attractive trade Proposition.

AUDIOTRON SALES CO.

Lick Bldg.

SAN FRANCISCO, CALIF.

NEW WAY to LEARN WIRELESS

Learn to transmit and receive messages by new direct method. No instrument or key needed—no instructor or assistant required. Learn in half the time with less effort. More accurate than any other system. None other like it—entirely revolutionizing.

COMPLETE INSTRUCTIONS

for Continental Code ONE DOLLAR post-paid. C. K. DODGE, Mamaroneck, N. Y.

Radio Parts Supplies

Bakelite-Dilecto sheet, rod, tubes. Hard fiber sheet, rod, tubes. Copper and brass sheets, rods and tubes, brass and iron machine screws, brass wood screws, molded knobs, switch points, and levers. Binding post, sheet aluminum. Hard rubber sheet, tuning coil cylinders, etc., etc.

Complete price list sent for 5 cents in stamps.

KEYSTONE RADIO COMPANY

Drawer 307 Greenville, Pa.
Formerly O. L. Bortz Machine Co.

I Want to Know

(Continued from page 640)

RADIO CONTROLLED CAR.

(175) J. C. Meyers, Buffalo, New York, asks:

Q. 1. Is it possible to construct a small car to be controlled by radio from a distant

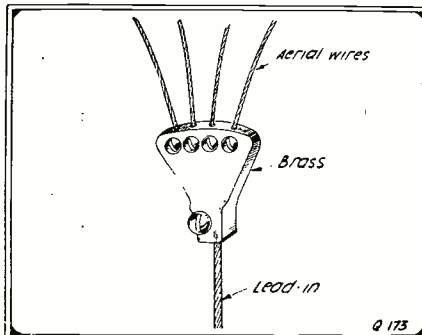

This Four Wire Aerial Lead-In Connector May Be Easily Made at Short Notice

point so that it can be made to start, turn either left or right, go backwards and stop?

A. 1. Yes, it is quite possible, but entails considerable complicated apparatus. We suggest that you consult the June issue of RADIO AMATEUR NEWS, which will describe

a so-called radio-controlled bus invented by Mr. Glavin.

Q. 2. Can a small loop aerial be used indoors to receive radio signals up to a distance of 500 miles or more?

A. 2. Yes, but you must employ at least a two step amplifier and other efficient receiving instruments. For amateur purposes, it is much better and certainly cheaper to erect a regular outdoor aerial of sufficient length to intercept long distance signals.

LAST ISSUE'S AMPLIFIER CIRCUIT.

In the April issue of RADIO AMATEUR NEWS, I-Want-To-Know section, page 565, two draftsman's errors were made which should be noted by experimenters intending to use this hook-up. The letters P and S (Primaries and Secondaries) should be reversed and a jumper connection should be placed at a point between the "A" and "B" batteries, i.e., the positive side of the "A" cells, and led to the positive wire, common to both the filaments. A suitable and simpler two-stage amplifier hook-up will appear in the June issue.

Dictionary of Radio Terms

(Continued from page 635)

attractions of the telephone magnets.

Dielectric—The insulator between the plates of a condenser. Every insulator used as such is a dielectric, even the rubber covering of a wire.

Dielectric Constant—The dielectric constant of a medium or substance is the ratio of a condenser capacity having this medium as a dielectric to the capacity of the same condenser having air as its dielectric. For instance air has a constant of 1; mica 5 to 8; glass 3 to 9, etc.

Dielectric Strength—The strain which a dielectric can stand without breaking down and permitting a spark to pass.

Direct Close Coupling—See Direct Tight Coupling.

Direct Coupling—A coupling in which the inductance coils of both circuits are metallically or directly connected. One in which all or part of turns are common to both circuits. See Direct Loose and Direct Tight Couplings.

Direct Current—D.C.—Current flowing continuously in one direction. Continuous Current.

Diffraction—The bending of waves around an obstacle. In the case of the earth the electromagnetic waves sent out from a radio transmitter follow round the earth's curvature to a large extent.

Direction Finder—Two Bellini-Tosi aerials at right angles, each of which has in the middle of the lower side a coil which acts inductively upon another coil in detector circuit, and which is capable of being swung until parallel with either aerial coil. Loudest signals are heard when swinging detector coil is parallel to coil of aerial whose plane is in direction of oncoming waves. In practise calibration is arranged to give readings so that weakest signals indicate direction, since zero position is much more sharply defined than maximum. Also known as Radio Compass.

Directive Aerial—A bent aerial gives greatest radiation in plane of aerial, but in opposite direction to which open or free end points. If an enclosed aerial, radiation is equal in both directions of the plane, and zero is at right angles to the plane. See Bellini-Tosi Aerial.

Directly Excited Aerial—Plain Aerial, P.A. One having the spark discharge taking place in the aerial circuit.

(Continued on page 662)

Variable Condensers of the Better Type

Note the square end piece on the cut of our condensers, facing the operator, also these condensers are enclosed in clear glass cases. Scales on these instruments are calibrated to 2 1/2 degrees.

Prices: R-35 21 plate \$4.75
R-34 43 " 5.50

ALL Instruments absolutely Guaranteed

THE TEWNO COMPANY

150 Chambers Street New York City

Vacuum Tubes Repaired

We repair the filaments and other elements in all types of vacuum tubes and guarantee them to operate equally as well as a new tube. In most cases they operate better. We produce wonderful oscillators, detectors, and amplifiers.

MARCONI VT DE FOREST VT
MOORHEAD TUBES WESTERN ELECTRIC

Repaired at Four Dollars and Fifty Cents each

ELECTRON RELAYS
OSCILLAUDIONS

Repaired at Four Dollars each

All Foreign-made receiving tubes repaired at Six Fifty and power tubes depending upon size.

We have purchased a large quantity of burned out Marconi Vts. and electron relays which we offer for sale at five dollars.

Remember these tubes are guaranteed good as new. Dealers write us.

VACUUM TUBE REPAIR CO.

511 Perry Building

Oakland, Cal.

A Closed Core Magnetic Rectifier

(Continued from page 624)

and have a maximum of 90 turns each. Wind them on a form $\frac{7}{8}$ " wide and take out a tap from the 45th turn of each. They are both to be wound in the same direction. Tape them separately as shown.

The cover or panel is made of "Formica" and is rather large so that the instrument may be mounted in an oil tank and run with heavier loads if desired. Another way of mounting it is to hang it in a wooden frame by coil springs to the corners. This method eliminates most of the noise of operation.

The armature should be made exactly according to the dimensions given in Fig. 4 or the writer will not vouch for its successful operation. Incidentally it took a great deal of experimenting to arrive at this construction. The copper contacts are riveted on with flat-headed copper rivets and also sweat-soldered to the springs. *Copper must be used for these contacts.*

The stationary contact holders are cut out of brass bar and fitted with some sort of fine screw feed. A flat spring should be screwed on the tops of them to hold the carbon contacts in place. These contacts are of $\frac{3}{8}$ " x $\frac{1}{2}$ " cross-section and should be of carbon, not graphite.

The proper location of the contacts is not shown in the picture but may be seen in Fig. 5.

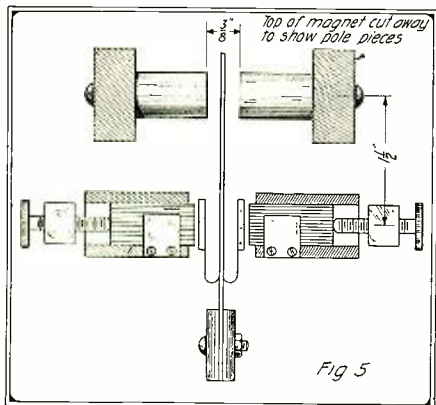

This Sketch Shows the Proper Location of the Contacts After Adjustment on the Vibrating Member of the Rectifier.

Mount the magnet to the panel with a pair of brackets and hold the iron pole pieces in place with the bracket screws. The distance between the pole pieces may have to be varied a bit for different strength of magnets but will be between $\frac{1}{4}$ " and $\frac{1}{2}$ ". Set the armature so squarely in the middle of the space that it is attracted to one pole no more than the other.

The switch is a double blade affair and is laminated. Its function is to change the charging voltage to 9 or 18 volts, as may be seen from the wiring diagram. When thrown to either side the battery circuit is broken.

All wiring should be of No. 12 solid copper in "Empire Cloth" tubing. Resin-core solder is the most suitable for electrical connections.

After the instrument is ready for operation it will be necessary to find the polarity of secondary circuit by test.

Charging current regulation may be had by means of a small rheostat, but it will be found that very good regulation is obtainable by adjustment of the contacts.

When starting the charge of an empty

(Continued on page 655)

Thousands of Electrical experts are needed now. Come to the great shops of Coyne and let us train you quickly by our sure practical way backed by 20 years of success.

Earn \$125 to \$300 a Month

Come to Coyne where experts train you on the actual apparatus. You work on everything from the simple bell to the mighty Generators, Electrical Locomotives and Power Plants. Everything to make you a Master Electrician. Look at the picture taken from life in our shops.

Become an Expert in 3 1/2 Months

No need of taking 1 to 4 years to become an expert. We have proved this in thousands of cases. We are the only school teaching by the original Coyne methods, which means no books, no classes—all practical training.

Earn Your Way. Our employment department will help every ambitious man to earn a part or all his expenses—without charge.

Bennett W. Cooke, Director
COYNE TRADE AND ENGINEERING SCHOOLS
 Dept. 114, 39-51 E. Illinois Street
 CHICAGO, ILL.

LEARN DRAFTING

The country needs hundreds of skilled Draftsmen in all lines at big salaries.

Coyne is the only school in the country that gives you the advantages of big shops full of construction and machinery. This makes our drafting courses practical, just like the job you'll have when you graduate. You can't get this in any other school.

WE TEACH ELECTRICITY, DRAFTING, MOTION PICTURE OPERATING AND PLUMBING

We teach all these professions in such a thorough, practical way that when you finish you can step right into a position of responsibility and big pay. Fill out the coupon now and send it for our big free book of information. It tells what others are doing and have done, what you can do.

Be sure and check the trade that interests you. Do it now!

COYNE SCHOOLS
 Dept. 114, 39-51 E. Illinois St.
 CHICAGO, ILL.

Please send me that big free book I'm interested in:

- Electricity Drafting Plumbing
- Motion Picture Operating.

Name

Address

$$\frac{1}{2} C V^2 N$$

Get a transformer whose voltage V remains high under load with a capacity C small enough for 200 meter work, and a rotary gap giving a higher number of sparks per second N.

High spark frequencies require lower voltages, which results in higher efficiency, both receiving and sending. High spark frequencies are more sensitive to both telephone and ear, and lower voltages mean less condenser and insulation losses.

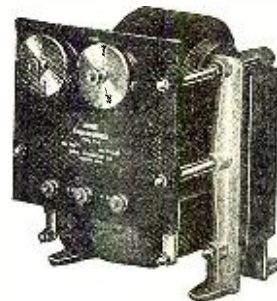

ACME TRANSFORMERS
 ALONE FULFILL THESE SPECIFICATIONS

Acme Apparatus Company
 Transformer and Radio Engineers and Manufacturers
 25 Windsor Street, Cambridge 39, Mass.

Use Your Judgment!

Remember that, if in your equipment buying, you go straight to the fair comparison between cheaply made apparatus and apparatus guaranteed to be dependable and efficient

Your choice will be

"ATLANTIC RADIO EQUIPMENT"

Why?

BECAUSE, all goods listed by us have been carefully selected, taking into consideration quality, appearance, dependability and service.

ATLANTIC RADIO CO.

88 Broad St.

Boston, Mass



RADIO INTERNATIONAL RADIO

SQUARE and LINEAR LAW VARIABLE CONDENSERS

The Square-Law Variable Condensers provide a most convenient element in all circuits for adjustment to wavelength. The Linear-Law Variable Condensers are used where capacities are to be measured and as energy storing units. The International Condensers are all housed in *standard* interchangeable cases, and may be incorporated in a complete receiving outfit of any type by adding to other International Sectional Radio Units such as Amplifiers, Detectors, etc.—at any time.

Write to Dept. 22 for International Experimental Bulletins completely describing these condensers, and our other products.

INTERNATIONAL RADIO TELEGRAPH COMPANY
326 BROADWAY, NEW YORK CITY

AMATEURS GET WEATHER REPORTS.

An amateur radio operator in North Dakota has written the Weather Bureau, United States Department of Agriculture, that he is daily receiving the weather forecast sent out by the powerful wireless station at Arlington, Va. In Kansas, according to reports, the State Agricultural College is now sending out weather reports by radio every morning except Sunday, for the benefit of a considerable number of amateurs, many of whom live in the rural districts of that state and so are able to be of service to the farmers in their neighborhoods. No doubt in other parts of the country there are many who are also "listening in" on the dispatches sent out by the high powered radio station.

The sending of the Weather Bureau's forecasts by radio is in charge of the Navy, hence at many points far inland it is not always possible for amateurs to pick up the messages. The Weather Bureau has carefully considered the possibilities of further use of the wireless in inland districts, but owing to an arrangement made some years ago whereby the bureau relinquished radio activity in favor of the army for inland communication and the Navy for coastal work, it has not been feasible to extend the forecast service in this manner. However, what the amateur in North Dakota and those in Kansas have been able to do suggests that others might "pick up" the weather reports thereby securing them considerably in advance of the published reports. To do this it will be necessary to ascertain the exact time that the forecast is sent out and the wave length used. The Weather Bureau will be glad to inform inquirers as to the points at which the Federal Government sends out weather reports by radio, but it will not have information of such activities by other agencies.

SIMPLE METHOD TO PROCURE A VACUUM.

Many amateurs who are constructing their own experimental vacuum valves find much trouble in obtaining a good vacuum. Here is a simple way to exhaust your valve.

Have a small glass tube projecting beyond the end through which to draw the air.

Get a rubber bulb, or ball, large enough to hold all the air contained in the valve and more and which should fit on the glass tube.

Squeeze all the air out of the bulb or ball, and holding it so squeezed, fit it on the glass tube.

Now let go and the air will be drawn out of the valve.

Leaving the bulb on, seal up the glass tube by holding it over a bunsen burner.

Contributed by CARL MASSON.

SPECIAL SALE!

We have on hand 2,000 Carbon Grain Transmitters as per photograph. They are first-class instruments and may be used for all kind of experiments, especially for wireless telephone sets, where a heavy current is to be passed through. Slightly used, but in perfect working order. Money refunded if not satisfied. A real bargain. Order one or more today.



Reduced Photograph of Transmitter showing nickel plated case and Hard Rubber Mouthpiece

\$1.00 ONLY

Postage extra.
Ship. Weight, 2 lbs.
Diameter, 3 1/4 ins.

THE ELECTRO IMPORTING CO., 231 Fulton St., NEW YORK

HERE'S A NEW ONE—WAKE UP BY RADIO!

This new form of "reveille" may interest some of our ex-Army and Navy readers. Chi Phi fraternity men at Ohio State University have no longer any excuse for missing classes. Uncle Sam, from the Arlington towers in Virginia, calls them by radio every day at 8 o'clock A. M.

By using springs of four double-decker beds as aerial, David H. Gerhard, a freshman, has rigged up a radio receiving set in the fraternity dormitory. Each morning when the Government sends out the time signals at 8 o'clock, a coherer arrangement sets off an alarm clock, giving the rising signal. What's next, ye radio insects?

Construction of a Mounting for Home-made Honeycomb Coils

(Continued from page 617)

from Fig. 5. (For the sake of clearness, the block in this figure is represented as being square-sided; in reality it is rounded as suggested by Fig. 4). Small brass blocks are used to hold down the band; they are shown in the figure as flat strips; a neater appearance may be had perhaps by using "half-round" brass rod. In fact, this was used on the writer's instrument. These strips should be just long enough to reach across the width of the block. Two small holes are drilled through them for passing small round-head screws. It is suggested that screws not over one-half inch in length be used, and that they be of small wire, so as to run as little chance as possible of splitting the block. First of all, fasten down the end of the band on the top of the block, using the brass blocks, as shown in Fig. 5; be certain that the edge of the wooden block and the edge of the band are in a straight line.

Next cut off the wire leads from the coil so that not more than an inch of wire extends beyond the outside circumference. Secure some telephone receiver cord for making the remainder of the leads. If triple-conductor cord can be obtained, not more than two feet will be needed, providing, of course, that the dimensions of the cabinet and panel are the same as those given herein. While the conductor of this receiver cord is more difficult to work with than stranded wire (it being composed of several strands of very fine copper ribbon), nevertheless its great flexibility certainly warrants its use. Draw the cord thru the hole bored thru the block for the purpose, from back to front, push back the silk covering and solder to the coil lead. The simplest way to remove the silk threads with which the conductor is interwoven is to apply a lighted match to the end, allowing it to burn far enough to make the proper joint. After soldering, wash the joint with water, wrap with thread and apply a little shellac. After soldering both leads in this manner, cut the cord at the proper length, being sure to leave enough to pass through the panel, down the back of same and thru the top of the cabinet to the binding post screws.

Next, lay the block and coil on their sides, making certain that sides are flush. Make a cushion, as shown at "A", Fig. 5, of two strips (double thickness) of rubber insulating tape, and place against the bumper blocks, so that the latter will not crush the wire when the band is tightened. With this cushion securely in place, push the coil up against it, at the same time drawing the cords through the block. The supporting band around the coil may best be tightened by grasping it about two inches beyond the point at which the brass block is to rest, and stretching it tight. While holding it tightly, and a little distance away from the lock, punch the holes for the screws and put the block in position. By holding the band away from the block and driving home the screws, it will be seen that the band is drawn still tighter, thus securely fastening the coil to the block. When both screws have been driven in, cut off the band behind the block with a sharp knife, and the mounting of the coil will be completed.

A little study of Fig. 5 will perhaps explain matters a trifle more fully. A drop of shellac or wax around the receiver cord where it comes from the block will tend to make it secure. All coils, of



Learn Telegraphy

(Wireless or Morse)

The **EASIEST, QUICKEST, CHEAPEST WAY**

AT HOME

In Half the Usual Time

WITH THE OMNIGRAPH

"Just Listen—The Omnigraph will do the teaching"

The Omnigraph is an *Automatic Transmitter* that teaches you both the Wireless and Morse Codes, at home, without any expense except the cost of the machine itself. Merely connect to battery and your Buzzer, or Buzzer and Head Phones, and the Omnigraph will send unlimited messages by the hour, at any speed you desire.

USED BY THE U. S. GOVERNMENT

The Omnigraph is used by the Government in testing all applicants applying for a Radio License. It is also used extensively by the large Universities, Colleges and Telegraph Schools throughout the Country for teaching Wireless and Morse. Hundreds of the Army's skilled operators who served during the war learned with the Omnigraph.

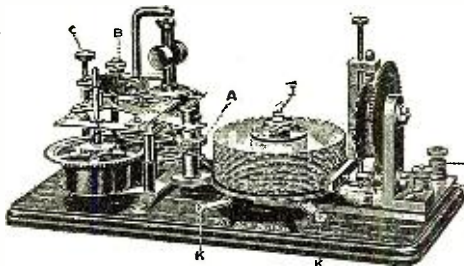

Let The OMNIGRAPH Teach You Wireless

For a few dollars you can have a complete outfit that will make you an experienced operator in the shortest possible time. No hard, laborious work—just learn by listening. The Omnigraph is adjustable so you can start receiving messages slowly, gradually increasing the speed as you become proficient.

You'll be surprised how quickly you will attain speed. Even if you are already an operator the Omnigraph will help you. It will make you more proficient, more accurate and more confident. Thousands of Omnigraphs are in use to-day and thousands of operators owe their success to them.

Write for Free Catalog

Send for a catalog to-day, showing the 3 different models, \$12.00 to \$28.00. Every Omnigraph is sold with the absolute guarantee that you must be satisfied or your money back for the asking. Mail the coupon to-day—the catalog will come to you by return mail.

The Omnigraph Mfg. Co.

39 F Cortlandt Street, New York City

The Omnigraph Mfg. Co.,
39 F Cortlandt St.,
New York City.

Gentlemen:—

As per your ad in Radio Amateur News please mail me your free catalog of Omnigraphs.

Name

Address

City..... State.....

REAL RADIO APPARATUS

Distributors—De Forest, Murdock,
Clapp Eastham Apparatus.
Perfection Tuners and Condensers.
Benwood Rotary Quenched, Honey
Comb Coils, Better "B" Batteries.
Phila. "Radisco Agency"

The First Wireless School in America.
Established 1911.

Day and Evening Classes.
Correspondence Course.

PHILADELPHIA SCHOOL OF WIRELESS TELEGRAPHY

Parkway Bldg., Broad and Cherry Sts.

"P. W." Audion Panel, \$11.00
without Bulb.

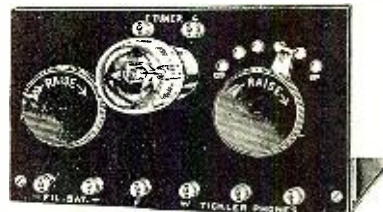

Best Polished XX Bakelite, lettered in white, a beauty. Use any American made bulb. Parts, ready to assemble, \$8.50.

How and Why of Radio Apparatus, by H. W. Secor. A book every Radio Operator should have (full description on page 664)—\$1.75. Experimenter Publishing Co., 233 Fulton Street, New York City.

A Bird in the Hand

ACE

—is worth two in the bush. Yes, Boy, and one readable signal is worth two unreadable signals.

Why not have readable signals? Using an antenna 2 wires 100' long, 30' high one end and 25' other end amateur signals *readable every night* are received in Cincinnati from Connecticut to Texas. No amplifiers used.

The Ace Regenerative Tuner does the trick. Range 150 to 2750 meters. Price \$55 f. o. b. Cincinnati.

You may pay more, but you can't buy better

The Precision Equipment Co.

2437 Gilbert Ave.

Dept. A

Cincinnati, O.

We Can Supply Anything Radio Advertised in This Magazine

LIST PRICE		MEMBERSHIP CREDIT PRICE
\$7.00	Marconi VT Tubes.....	\$6.50
6.00	Audiotron Tubes.....	5.50
15.00	Marko Storage Batteries.....	7.00
5.00	.001 Mfd. Condensers Variable...	3.50
1.25	Audiotron Adaptors.....	1.00
	Honeycomb Coils.....	10% off
7.00	Brandes Receivers.....	6.25
1.35	Signal Corps B Batteries.....	1.00
1.50	Marconi VT Base.....	1.35

WE LIST THE ABOVE TO ACQUAINT YOU WITH THE SAVINGS OUR MEMBERS ARE MAKING. WE CAN SAVE MONEY FOR YOU ON ACME, ADAMS MORGAN, AMRAD, BRANDES, CLAPP EASTHAM, DE FOREST, FEDERAL, GREBE, INTERNATIONAL, KLITZEN, MURDOCK, MESCO, MIGNON, OMNIGRAPH, RAWSON, RADISCO, SIEGERT, SKINDERVIKEN, STROMBERG CARLSON, SHOTTON, TRESKO, THORDARSON, VIBROPLEX, WIRELESS IMPROVEMENT, WIRELESS PRESS, AND ALL OTHER MANUFACTURERS GOODS.

MEMBERS ORDER AS USUAL—OTHERS WRITE FOR DETAILS.

MUTUAL PURCHASERS ASSOCIATION

2 and 4 Stone St.

Dept. RA.5

New York

WIRELESS MANUAL-M12

Our 180 Page Combined Manual and Catalog Illustrates and Accurately Describes the Uses of Standard Radio Instruments.

We Make a Charge of 25c for it, Issuing a Coupon Receipt Redeemable on a Purchase of \$5.00 or More.

You cannot get satisfaction from wireless instruments unless they are absolutely perfect. The slightest imperfection in construction destroys their efficiency. We catalog and offer for sale wireless apparatus of the highest quality, guaranteed to be mechanically and electrically perfect.

Get a copy of our complete wireless catalog and order all of your radio material from one source of supply and save trouble. Ready about May 25. Send in your request now.

MANHATTAN ELECTRICAL SUPPLY CO., Inc.

New York—17 Park Place
Chicago—114 S. Wells St.

San Francisco—604 Mission St.
St. Louis—1106 Pine St.

MONEY for YOU Add to your Salary—Make extra Pin Money Start a lucrative business of your own. Spend an hour each day taking subscriptions for the "Radio Amateur News." We'll pay you well and you'll enjoy the work. Write for full particulars. Circulation Dept., RADIO AMATEUR NEWS, 236 Fulton St., N. Y. City.

course, are mounted in this same manner. The dimensions and design of the panel and cabinet may be left to the reader, altho it is suggested that they be somewhat similar to those given here. The panel was constructed of seven-eighths-inch soft pine, six and one-half inches high by fifteen inches long. The sides of the cabinet were two and one-half inches high by eleven by fifteen inches. The panel was mounted two inches in front of the rear of the cabinet top, thus leaving sufficient space for mounting six binding posts behind the panel.

Mount the panel on the cabinet first, and then screw the coil-mounting brackets to the panel. Next drill two three-sixteenths inch holes thru the top of the cabinet, and exactly beneath the sockets in the two outside bracket arms.

Next cut two pieces of the brass rod so that they will pass thru the holes in the cabinet top, and, resting in the sockets in the brackets, will extend below the top of the cabinet about an inch. All these dimensions must be left to the individual builder, as they must necessarily depend upon the size of the gear wheels used, etc. Thread one end of each of these rods for a distance of a little over one and one-half inches. Put on one nut, pass the threaded end of the rod thru the coil-mounting block and fasten securely with a second nut, as in Fig. 5. The rod must extend a short distance above the top nut, so that it may fit into the socket in the bracket arm, as shown. If the socket has been smoothed out as previously suggested, the thread of the rod will in no way catch when the rod is turned in the socket.

Make a bracket of brass or copper, as shown in Fig. 6, at "A". Drill a three-sixteenths inch hole through its center and mount it on the under side of the cabinet top, as shown. This bracket must support the weight of the coil and block, so care should be taken to mount it securely.

It will perhaps be found more convenient to pass the threaded end of the rod up thru the bracket and top of the cabinet before the coil is mounted on the rod; in this case, pass the collar with its accompanying set-screw ("B", Fig. 6) over the rod as it passes thru the bracket. When the coil has been mounted on the rod, see that the end of the latter fits snugly in its bracket socket; then tighten the collar set-screw. Inasmuch as this collar carries the entire weight of the coil, it should be fastened securely to the rod; a little vaseline between the bracket and collar will insure its smooth operation.

"C" and "D", Fig. 6, are small brass plates with holes through their centers, which form bearings for the brass rod. The end of the rod is sunk into a hole bored part way thru the rear of the cabinet, as shown. This hole should be slightly reamed so that the rod will turn freely in the brass bearing. A collar is fastened to the rod against the front bearing to keep rod in place. The knob may be glued to the front end of the rod.

The gear wheels used on the writer's instrument were taken from a popular make of boys' building set; they were of brass, and suited the purpose very well. Bevel gears may be used just as well, however.

The holes thru the panel, thru which the coil leads pass are bored between the brackets; in this way the wire is almost entirely hidden from view, and gives a neater appearance. It goes without saying, of course, that the brackets should be mounted close enough together on the panel so that when the axes of the three coils form a straight line, the coils will touch each other.

It might be noted that all three of these coils hooked in series gave excellent results; the operator may use any hook-up desired, of course, and while the binding posts are hidden from view for the sake

of appearance they are easily reached behind the panel.

In building a coil-mounting of this kind it of course requires more or less patience; but the modern enthusiastic amateur generally does not think of the extra time put into the work when his job is done and he has the satisfaction of admiring his handiwork.

A Closed Core Magnetic Rectifier

(Continued from page 651)

battery the instrument will buzz very loudly. When the charge is nearly complete the noise will have dropped to a mere hum, due to low current value of the charging circuit and the resulting decrease of the flux.

Fellows, this is the remedy for that constantly rundown storage battery and it works. Get busy and make one yourself!

MORE STRANGE SIGNALS.

Mr. F. G. Roebuck, chief radio operator of the *S. S. Hugoton*, reports a very strange spark happening on his recent trip from San Francisco to New York via Panama Canal. This unusual spark occurred between March 3 and March 21 on the rather rare wavelength of 375 meters and consisted of a series of steady musical drones having a perfect eight note scale. This did not seem to be a local condition as Mr. Roebuck had occasion to hear the *S. S. Acme* comment on the strange spark and at that time the latter vessel was nearly 1,000 miles west of Honolulu. The naval operators at the Canal Zone stations as well as many American amateurs also complained of the interference which this spark caused. A strange fact connected with this incident was that the spark seemed to get stronger as the ship neared the equator.

Incidentally these strange signals bring to our mind much conjecture as to their origin. So much has been said on the momentous subject of inter-planetary communication that it occurs to us music such as described here would not be far from a logical means for other planets to communicate with this earth. We assume of course that if a race of people exist on other planets such as Mars, they would be familiar with acoustics and music, such as we know them. Therefore, if attempts are made to communicate with the earth, why should music not be a logical means for an initial message? In other words, a perfect eight note scale is understandable to us, and while not disclosing the eternal mystery of the planets to us, it would nevertheless be an intelligent means of approach.

Of course, some of our radio experts will tell us that the short wave of 375 meters is infinitesimally small as compared with the wavelength necessary to travel so many million miles—that is, judging from our present radio standards and knowledge, but who can say that another intelligent planet race have not devised a system of radio communication with possible means of propagation on extremely small wavelengths? Think it over, boys.

EXTRA—ALL CATS LOSE THEIR JOBS.

Mother: "What makes the cats so tame now?"

Father: "Lee De Forest must be responsible for that."

Mother: "Why?"

Father: "Billy now uses an audion instead of a 'cat whisker' detector."

JAMES N. WHITAKER.

Santa Rosa, Calif.

**Stromberg-Carlson
Radio
Head Sets**

Equipped with Non-conducting spool heads and slotted pole tips which eliminate eddy current losses.

All operating parts of the Stromberg-Carlson Radio Head sets are housed in dust-proof and moisture proof aluminum cases. Diaphragm is mounted metal-to-metal. Temperature variation will not disturb the airgap adjustments. Each set is wound to a resistance of 2,000 ohms with pure copper wire and furnished complete with 6-foot moisture-proof cord attached. This set, while it is constructed strong and durable, is very sensitive. For use ashore or aboard ship.



A sample set will be sent upon receipt of \$12. Try it in your own station for private and commercial Radio Service. Money refunded if not satisfied.

Bulletin 1206 Gives Full Particulars. Write.

STROMBERG-CARLSON TELEPHONE MFG. CO.
Rochester, N. Y., U. S. A.

ATTENTION AMATEURS

The only practical adapter

Price \$1.50

RADISCO AGENCY

We make up sets to specifications



Made by the

AMATEUR WIRELESS EQUIPMENT CO.
1390 Prospect Ave., Bronx, N. Y.

SOLD BY THE
INTERNATIONAL ELECTRIC CO., 224 Fulton St., N. Y. C.

Catalogue sent on receipt of 10c, which may be deducted from first order.



Dealers write for proposition

Build Your Own Wireless Receiving Set



Think of the pleasure and practical experience you will gain in making your own set. You can save at least \$25.00 by buying the parts and assembling it yourself. This is not a toy, but a regular, large sized set (16"x 8"x6") capable of receiving messages ranging in wave length from 170 to 2,500 meters. We will furnish you with large, full sized blue-print and full information concerning winding of coils, mounting of instruments on panel, "hook up"—in fact complete detailed instructions written in plain, easy to understand language.

Our Offer is This:

Send \$1.00 and we will send you the blue-print and instruction sheets—also prices of all parts. When you order at one time \$5.00 or more worth of parts, you may deduct this \$1.00 from the total. Since the blue-print and instructions alone are worth \$1.00, and since we can save you money on wireless material, you cannot possibly lose. So send \$1.00 to-day before this slips your mind and start making your set as soon as possible.

K. & G. Wireless Supply Co.

Dept. 16B—152 Chambers Street

New York City

Announcement

Messrs. JOSEPH STANTLEY and JOHN DI BLASI

take great pleasure in announcing to their many friends that on May 1st they will engage in business for themselves as the

CONTINENTAL RADIO AND ELECTRIC CORPORATION

at 6 WARREN STREET, NEW YORK CITY

These gentlemen have been affiliated with the electrical field, commercially and experimentally, for many years.

Mr. Joseph Stantley has been connected with the Manhattan Elec. Supply Co. for the past eleven years and during that time acted as manager of their Radio Department.

Mr. John DiBlasi has also been identified with the Manhattan Elec. Supply Co. for the past four years, and lately acting as general manager of their Radio Departments.

It is the earnest aim of this enterprise to furnish all manner and kind of Radio and Electrical apparatus and supplies necessary to the highly technical experimenter as well as to the novice. A special endeavor will be made to please all customers, both in the vicinity of New York and distant points throughout the country. If you live nearby, drop in and see us; if far away, drop us a line and try us out.

A combination of fair prices with quick and satisfactory service will be the first consideration offered to all our customers.

Our word of honor to you is our guarantee. Let us prove it.

Continental Radio and Electric Corporation

Variometers

(Continued from page 619)

It might be thought at first that when the coils are arranged in this way the resultant field would be zero because of the fact that the two fields are equal and opposite, and should neutralize each other. Such is not the case, and a glance at Fig. 3 will explain it. The field set up by each coil may be considered as being composed of two parts, the part inside of the coil, and the part outside of the coil. These two parts are of course equal and opposite for the same reason that the current in the return lead of a direct current circuit is equal and opposite in direction to the current in the outgoing lead. Then since the coils are so arranged that their fields are in opposite directions, the field inside of the large coil must be going in a direction opposite to the field on the inside of the small coil, and the field on the outside of the large coil is going in a direction opposite to the field on the outside of the small coil. Then, in the space between the two coils the resultant field is made up of some of the outside field of the small coil and some of the inside field of the large coil. These two are in the same direction. Therefore, in this particular vicinity the fields will not neutralize, and for this reason, the inductance of the two coils when coupled in this manner will not be zero. This may be termed the leakage field of the two coils, and bears the same relation to the coils that the leakage field between any 2 turns bears to one coil.

Now, in place of the coil 3 inches in diameter of 152 turns substitute one 5 3/4 inches in diameter having 70 turns of the same wire. This will have the same inductance as the other, and the shape of its field will be nearly the same as that of the 6 inch coil. The leakage field will only be an eighth of an inch on each side of the coil instead of an inch and a half as before, and the drop in the resultant field as the two coils are coupled will be much greater than in the first case. In fact, it is doubtful if there would actually be any noticeable change in the total field, as the coils in the first example were coupled, because it could easily happen that the tendency of the leakage field to increase the total would be as great as the tendency to neutralize, and there would then be no resulting change.

If now the inside coil is taken out, turned around, and put in the other way, another effect is produced. This time the fields of the two coils are aiding each other everywhere except in the very small leakage space where they oppose. The resulting field will now be much greater than the sum of the two fields when they are not coupled. It is important to note that the strength of this field can be varied continuously by simply changing the coupling between the two coils. Remembering that when the tap switch on a loading coil is varied all that really happens is that a change is made in the strength of the electro-magnetic field of the coil, it can easily be seen that a variometer of the correct dimensions should be substituted for the loading coil and that the resulting adjustment would be much finer than is the case with the tap switch.

The following points are of greatest importance in the above discussion, and should be emphasized before the question of designing a variometer is taken up in detail:

1. The winding on the variometer coils should be as close as the insulation of the wire will permit.
2. The winding should consist of a single

AT LAST!! RIGHT PRICES!!

"B" Batteries IMMEDIATE SHIPMENT

22 1/2 volts, Life 1500 Hours. Sizes: 2 3/4 x 3 1/2 x 4 1/2". Postpaid \$2.00
45 volts, Life 1500 Hours. Sizes: 3 1/2 x 4 3/4 x 5 3/4". Postpaid \$4.20

UNIVERSAL
RADIO
VARIOMETER

Price Lists on Request

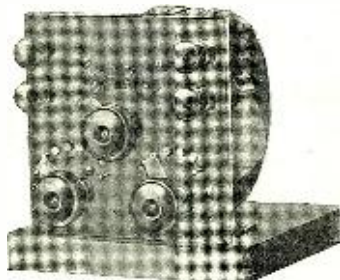

Type "S-1" 1000
Meters — \$12.50

Type "S-2" 2500
Meters — \$12.50

In ordering please
specify winding. Size
6 x 6 x 6 inches.



Radio Call 3 E K

Phone Main 2833

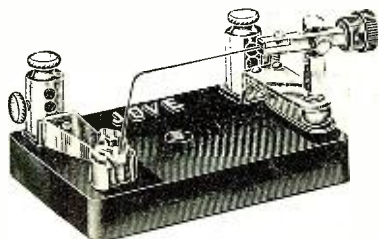

(GHEGAN PATENT)

Bunnell INSTRUMENTS Always Reliable

JOVE DETECTOR

Handiest, Handsomest, Best
Sample by Mail, \$2.00
Tested Galena Crystal, 25c

We are distributors of the Standard Electric Novelty Co.'s Type B "Cyclone" Audion Batteries. Also of De Forest and all the leading manufacturers of High Class Wireless Apparatus. Send stamp for new edition 42RN Catalog.

J. H. BUNNELL & CO., 32 Park Place, New York

READ THE CLASSIFIED ADVERTISEMENTS ON PAGES 668-670, YOU'LL FIND MANY GOOD THINGS THERE.

layer only. Both of the above points tend to reduce the leakage field within the coil itself.

3. The coils should be as large in diameter as is practicable. When the diameter is large, the ratio of the space between the inside and outside coil to the total space inside the big coil is made smaller. Thus the leakage between the two coils is a smaller proportion of the whole field.

4. The windings on the inside and outside coils should be as close together as possible, just enough space being left between them to permit of adjusting the coupling.

5. The inductance of the outside coil should be exactly equal to that of the inside coil. This may either be computed or measured with a wave meter and condenser.

6. Means should be provided for reversing the direction of the field of one of the coils. This makes it possible to take advantage of both the opposing and aiding actions of the two fields, and greatly increases the range of the variometer.

From the above it is obvious that the design of a good variometer is going to be a problem that requires considerable study, both from an electrical and a mechanical point of view. The latter point practically eliminates sliding one coil in and out of another as a means of adjusting coupling, because with the sliding coils the fields could not be reversed without a switch, and one of the advantages of a variometer is that it does away with switches.

The only type of variometer so far designed that successfully fulfills all of these

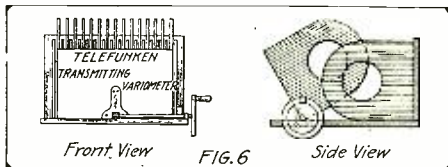

This Shows the Construction of a Transmitting Type of Variometer. Note the Coupling Arrangement.

requirements is the familiar ball or apple type. Here, the movable coils are wound on a spherical form that rotates inside of the fixed windings. Rotation is thru an angle of 180 degrees, and when the rotor (the movable winding) is in the 90 degree position the two fields are at right angles to each other. In this position the fields neither aid nor oppose, and the result is the same as if the two coils were in different parts of the circuit, the coupling between them being nearly zero. From zero to 90 degrees the two fields oppose each other, and from 90 to 180 degrees they aid.

(Continued on page 658)

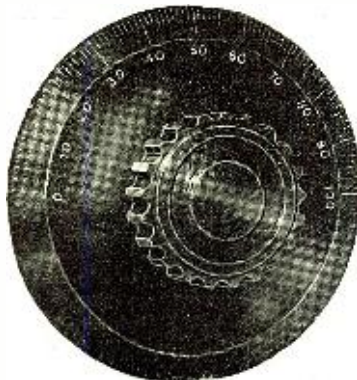

Indicating Dials

Make your radio apparatus up to date. Indicating dials now available at a reasonable price.

Made of fine black polished composition with radial lines and figures accurately engraved and filled with brilliant white. Diameter of dial is 3 inches and they are 3/16 inch thick. Have bevelled edge. We can furnish dial alone or with fine Bakelite Knob mounted. This knob has a set screw to clamp shaft of instrument to which dial is to be applied.

3 inch Dial only.....75 cents
Postpaid
3 inch Dial with Knob mounted..\$1.30
Postpaid

If your dealer cannot supply you send us his name with your order. Immediate deliveries.

OUR NEW CATALOG now ready for distribution, contains 24 pages of real, live, up to the minute illustrations, news and descriptions of all standard Radio parts, including the above Indicating Dial.

Sent anywhere upon receipt of 10c.

For sale at all Radisco Agencies and by

A. H. Corwin & Co.

4 West Park Street

Newark, N. J.

AT LAST A RELIABLE AUDION CONTROL UNIT

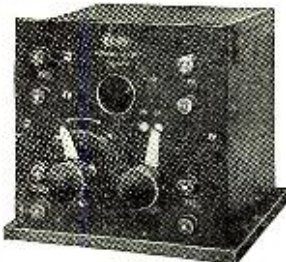

Type RORH Grebe Audion Control Unit complete with two standard "VT" batteries, but less tube. Price \$17.00. Same as above, less batteries and tube. Price \$15.00. The Grebe latest Audion Control Cabinet type RORH contains the grid condenser, grid leak filament rheostat and two Standard V.T. plate batteries. The socket accommodates the usual 4 prong tube. Suitable binding posts for secondary, tickler, phones and filament battery are supplied which enables the user to use every type of circuit known without difficulty.

Bulletin R-117 describes this unit. It's yours for the asking.

New Grebe catalogue showing the complete line of Grebe's correct designed apparatus will be sent to you for 10 cents.

Dealers, Jobbers and Distributors write for our proposition.

Exclusive Agents for A. H. Grebe & Co., Inc., Dubilier Condenser Company, Rawson Electrical Instrument Co., Richter and Byrne, Electrical Products Mfg. Co., and others.

PACENT ELECTRIC COMPANY, Inc.

Builders and Specialists of Radio, Electrical and Laboratory Equipment

150 NASSAU ST.

Telephone
Beekman 5810

NEW YORK CITY

THE NEW YORK ELECTRICAL SCHOOL

THE N. Y. ELECTRICAL SCHOOL is the pioneer and premier school of the "Learn by Doing" method. When you have completed this Course you shall be fully qualified to handle ALL branches of Electrical industry. The equipment of this School is unequalled and up-to-the-minute. No preparation needed to become a "learner" in this school. You can start to learn on any day of any week throughout the whole year. Send for catalogue.

OPEN ALL SUMMER

NEW YORK ELECTRICAL SCHOOL
29-31 West 17th St. New York City

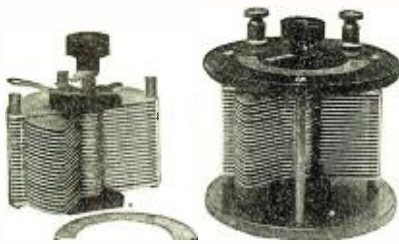

The "ILLINOIS" VARIABLE CONDENSER

Hard Rolled Aluminum Plates

Three Styles, No. 1. Panel, No. 2. Open Type as shown, No. 3. Fully Encased. Anti Profiteer. Less than pre-war prices. Fully assembled and tested.

Sent Prepaid on Receipt of Price

Style No. 1	No. 2	No. 3	Money back if not satisfied. Just return condenser within 10 days by insured P. P.
\$3.00	\$4.00	\$4.25	
2.50	3.50	3.75	
1.35	2.25	3.25	

In Canada 25c additional
These condensers are made by a watch mechanic schooled in accurate workmanship. Personally we will need no introduction to Amateurs who have "listened in" for "time" and "weather" from 9. ZS.

Postscript.

The above "Ad" certainly put "ILLINOIS" "on the map" in the Condenser Industry. Not only on the map, but scattered it all over the map, from Alaska to the Gulf, and from the Penobscot to the Golden Gate. The "money back" proposition seems to have been superfluous. Instead of having any instruments returned for credit, they ask for more. And, most satisfactory of all to us, our customers write to express their appreciation. All these, we take this occasion to thank heartily.

You will note a slight increase in our price list, on the "mounted" styles only. This will be effective from May first. The fact is we could not quite "get by" with our first prices.

The "Star Spring" feature of our design meets with great favor. We shall make this the subject of application for Patent, as we think it marks a step forward in the construction of Variables. It has two important functions. It keeps the plates accurately and permanently centered; without "endshake"; and provides sufficient friction to hold the "rotor" at any setting without liability of its dropping from its position by the unbalanced weight. It makes the Condenser, in this respect as reliable as the much more expensive "balanced" type.

Kindly note: We issue no Catalog, and make no "trade discounts." We set our price at the lowest limit, and leave the "middle man" out for the sole benefit of the "consumer."

G. F. Johnson, 625 Black Ave., Springfield, Ill.

BURGESS "B" BATTERIES

SEVERAL SIZES FOR SPECIAL WORK



SEND FOR CATALOGUE BURGESS BATTERY COMPANY

HARRIS TRUST BLDG. - CHICAGO, ILL.

Arnold

Loose Couplers
Combination Loose Coupler Parts and accessories.

Send 3c stamp for literature which is sure to interest you.

J. F. ARNOLD

2082 Lexington Av. N.Y. Established 1910

Another type of variometer that has appeared on the market recently is the "figure 8" type. These variometers as a rule are less efficient than the ball type because of the fact that the fields of "figure 8" coils are very concentrated and the leakage field of the variometer is thus much greater than in the other type. The field of a "figure 8" coil is shown in Fig. 4. Note that the direction of the lines of force in the lower half of the winding is opposite to that in the upper half, because the winding reverses itself as it passes thru the center of the "8." Thus a complete magnetic circuit is formed by the two fields of one "figure 8" coil, and as a result, the lines of force tend to take the shortest path, and are nearly all drawn down next to the coil itself. The variometer is made by placing two of these "figure 8" coils face to face and rotating one of them. When they are in the position indicated in Fig. 5 the fields are aiding each other. If one of the coils is now revolved thru 180 degrees the fields will be opposing and this will be the minimum position. In order to obtain much variation between minimum and maximum position it is necessary to place the coils closer together than is mechanically convenient, and for this reason they do not as a rule compare favorably with the ball type. However, they have a great advantage in that they are compact, and if the experimenter has sufficient patience and follows closely the six rules outlined above he can construct a fairly good one.

The range of variometers is measured in terms of the inductance ratio, this ratio being the inductance of the variometer in maximum position divided by the inductance in minimum position. There is no such thing as the wave length range of a variometer, altho advertisements are frequently seen stating that a variometer will tune from 200 to 500 meters, or from 900 to 2,500 meters, etc. The wave length of the circuit is not determined by the variometer alone, but depends on the amount of capacity in the circuit, and also on the size of coil that is in series with the variometer. Variometers on sale at present show inductance ratios of around 5, which is not very good. Laboratory variometers have been built with ranges much better than this, ratios of 50 being obtained in some cases. It is by no means impossible to secure a ratio of 25 by carefully designing a ball type variometer. The problem of obtaining a high ratio becomes more difficult as the maximum inductance value required is increased.

A variometer, like any other piece of apparatus, has its uses and misuses, and its value in different parts of the circuit depends on the fineness with which the inductance in that part has to be adjusted. It is not needed at any time in the antenna circuit, and is of no appreciable value in any part of a crystal detector circuit. On the other hand, in vacuum tube transmitting and receiving sets using tuned grid and plate circuits it is indispensable, because the tuning of both plate and grid circuits must be done by means of inductance.

In ordinary vacuum tube receiving circuits a variometer is sometimes connected in series with the secondary of the loose coupler to take the place of a fine adjustment tap switch. This is bad practice, as a variometer connected in this way frequently adds considerable resistance to the circuit and decrease of the received signal results. The tuning in this case is best done with a shunt variable condenser.

Generally speaking, a variometer in a spark transmitter circuit is a bad thing, especially on 200 meters. Unless the greatest care is taken with the design, the resulting instrument will add enough resistance to the circuit to seriously reduce radiation. They are not used at all in the U.S. commercial or government sets.

Transmitting variometers are a practical thing, however, if sufficient care is taken in

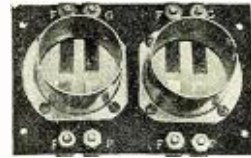

TYPE S3

When you buy a **RADIO SERVICE V.T. RECEPTACLE**

you obtain the same material and workmanship as specified by the U. S. Navy for this class of apparatus.

A grade XX Bakelite Dilecto base, the best insulating material known, flat phosphor bronze contact springs and an aluminum socket, not cast, but spun from hard sheet aluminum. The complete unit so assembled as to always make perfect contact with your bulb.

These Receptacles were not designed to meet price competition, but constructed to give you the best obtainable no matter what price you pay.

- Type S1—Single Tube (for inside mounting).....\$1.20
- Type S2—Single Tube (for bench and experimental use).....1.75
- Type S3—Double Tube (for amplifier use).....2.75
- Type S4—Triple Tube (for detector and two-stage amplifier or three-stage amplifier use)....3.75

The above receptacles are all made in two styles, for either receiving or transmitting tubes. This should be specified when ordering.

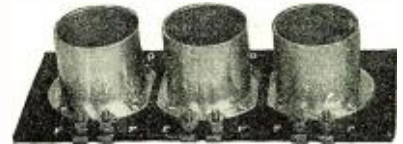

TYPE S4

RADIO SERVICE & MFG. CO.
LYNBROOK, L. I. NEW YORK

Everything You Want To Know About A. C. Motors

is found instantly in the **ELECTRICAL WORKER'S FRIEND**. The only complete book of its kind for the man on the job or the student. Will make you an expert motor repairman. Contains 66 electric motor drawings with complete instructions for rewinding and reconnecting. Tells how to put each coil in the slots, how to get speed, alternations, cycles, poles, how to find the coil throw, number of coils per group and number of groups, etc.

Covers all practical reconnecting changes from one phase to another, from one voltage to another, or changing both the phase and voltage at the same time.

Written so you will understand it. You need this book—send for a copy today.

\$4.00 or we will ship C. O. D. if you prefer

Free Circular on Request

Henry F. Bosshart

P. O. Box 68, Homewood Sta., Pittsburg, Pa.

The Radio Engineering Company
MANUFACTURERS OF



"RADIO APPARATUS"

Beg to announce their reorganization and the opening of a show room and distribution center FOR THE SOUTH, of all standard radio apparatus.

The famous "RECO" KEY

reduced for a short time to \$6.50. Six cents in stamps will bring our new and revised catalog now on the press.

Note New Address:

616 N. Calvert St., Baltimore, Md.

CAT. 2 EM



HERE IT IS
A sign for your den. Exceedingly attractive. Printed in bright red on white cardboard. No electrical bug should be without it. 7 1/4" x 11 1/4". 10c each in coin ONLY. Send stamp for postage. LEONARD BECK, 1298 Carroll St., Brooklyn, N. Y.

their construction, and they were used successfully in the sets supplied to the German and Austrian navies by the Telefunken Co. One Telefunken variometer with which the author had considerable experience was a part of the 10 K.W. transmitting set aboard the ex-Austrian battleship Radetzky. This variometer was of unique design, and consisted of two sections, each composed of about 12 pancake coils. The coils were wound with 3 or 4 turns each of the best Litzendraht braid, and all of the pancakes in each section were in series. They were so spaced, however, that the coils of one section could be moved in and out between the coils of the second section, in somewhat the same way as two pieces of wood having a dovetail joint along one edge could be joined or pulled apart. Thus when they were together the whole had the appearance of a single coil, and when they were fully separated they appeared to be two coils. The two sections were connected in parallel instead of in series, probably because of the fact that they had to carry 30 amperes, and the field of one section opposed that of the other. Thus, when they were jammed together the inductance was a minimum, while when they were pulled apart a magnetic circuit was formed, in thru one coil and back thru the other, increasing the total inductance considerably. This particular variometer had a ratio of nearly 15, its minimum value being 6 microhenries and its maximum 88.

As a matter of interest, the writer removed the variometer from the circuit and substituted a loading coil of the ordinary cylindrical type, believing that it would be more efficient. It turned out the other way, however, and the variometer was so well designed that better radiation was obtained when it was put back. Fig. 6 is a diagram shown in the construction of this variometer.

Radio Digest

(Continued from page 628)

ation to-day over the longest ranges ever attempted on a commercial scale—it is also being installed for long-distance communication in high-power stations in England and abroad, as well as in numerous stations and ships for shorter ranges.

It will be remembered that at the Parliamentary inquiry regarding the contract for the Imperial Wireless Chain in 1913, the Poulsen system was put forward as a practicable alternative to the Marconi system, largely on the strength of the establishment of communication between San Francisco and Honolulu, but the evidence available regarding the results obtained was meager and unconvincing. That was, at the time, the longest range in commercial operation (2,100 miles), and the installation was carried out by the Federal Telegraph Co., U. S. A.

At the present time 20,000 kilowatts of arc generators are in use thruout the world. A few of these stations, no doubt familiar to many amateurs, are located at Honolulu and San Francisco: Horsea Island; Portsmouth with a range to the Dardanelles; Rome with Washington; Lyons and Nantes communicating with the United States; the Eiffel Tower communicating with Bucharest; Salonica and Paris, etc.

Improvements are constantly being introduced, and the speed of transmission has been raised to 100 words per minute by automatic operation. Amongst the stations at work or building with Poulsen arc generators of 100 K.W. and upward, some 24 in number, in addition to those mentioned above, are those at Bordeaux, Cairo, Cordova, Leafield, and Newcastle, and about eight in the United States.—Abstracted from *The Electrical Review* for April.



VIEW IN RADIO LABORATORY

Positions constantly open on vessels plying to South America, the Orient, Alaska, Hawaii and Atlantic Coast. Salaries, \$125 and expenses. Best equipped Radio School on Pacific Coast. For further information address

**Y. M. C. A. School of Radio
Telegraphy
Seattle, Washington**



**Become a
Commercial
Operator
on the
Pacific
Coast**



Prices subject to change without notice.

PANEL TYPE RHEOSTAT

This rheostat is a new departure in rheostat designing, combining, as it does, the low cost of a front designed rheostat with the advantages and neatness of a back-connected instrument.

The resistance element is mounted on the back of the Bakelite knob in a groove provided for that purpose. Resistance is 5 ohms. The rotation of 360 degrees allows extremely close adjustment. Taken all in all we do not believe that this piece of apparatus can be surpassed by any other on the market today at anywhere near the price.

Panel type rheostat, \$1.00. Shipping weight, 1 lb.

Electrical Specialty Company
48-50 South Front St. Columbus, Ohio

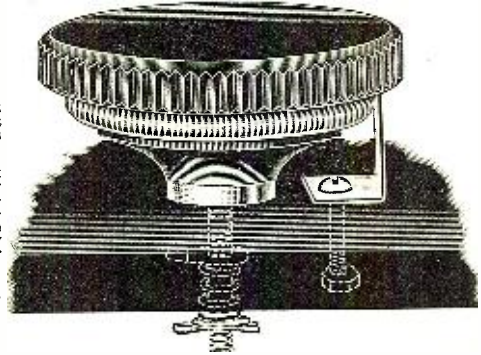

**OH BOY! OH JOY!
COPPER AERIAL WIRE, 2 FEET FOR 1 CENT**

This phenomenal sale will not continue much longer as our stock is getting low. The above wire is made of the best grade of Lake Superior copper. The gauge is No. 14. We also handle this wire at 80c per 100 feet in the No. 12 gauge. The No. 14 wire runs 80 feet to the pound and the No. 12 runs 50 feet. When ordering include postage and insurance, otherwise the wire will be shipped by express collect. No C. O. D. shipments of this wire will be made. Check, money-order or cash in registered letter must accompany all orders.

Look, Fellows, Something New!

“WIRELESS TELEPHONE COURSE”

Covering theory and practice of Electricity, Radio and Wireless Telephony, course complete in every respect. A wonderful future is awaiting men who enter this young and entirely new field. MEN will be in great demand, as Wireless Telephones are now being universally used, and becoming more and more popular every day.

A small payment will start you in on this very interesting and practical correspondence course. FREE—Vacuum tube and miscellaneous apparatus given free to each student. Immediate action will assure you of a good future. Write for further details.

CHICAGO ELECTRICAL ENGINEERING CO.

Dept. J.

1000 Diversey Parkway

Chicago, Ill.

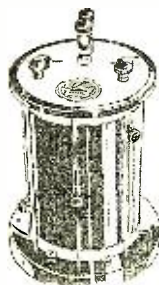

Price \$15.00
Made in Canada

FOR CANADIAN AMATEURS

**Complete
CRYSTAL RECEIVER
Range: 50 to 3000 Meters**

This Crystal Receiver is specially designed for amateurs. It combines wide range of reception with simplicity of operation. Wavelength 50 to 3000 meters. We also supply a complete amateur Transmitting Set and carry a large stock of condensers, transformers, telephones, keys, detectors and all other articles of amateur equipment. Send five cents for latest catalogue.

SCIENTIFIC EXPERIMENTER, Limited
11 St. Sacramento St. Montreal

"SERVICE"

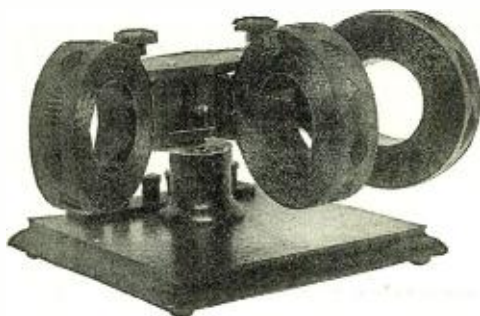

"QUALITY"

Use Only Dependable Radio Apparatus

COMPLETE STOCK

De Forest, Grebe, Thordarson, Bunnell,
Acme, Murdock and Other Standard
Apparatus for Immediate Delivery

Catalog upon Request

DOUBLEDAY-HILL ELECTRIC CO.

Radio Dept., Desk B

715 12th St. N. W.
Washington, D. C.

719-21 Liberty Ave.
Pittsburgh, Pa.

Announcement

Summer session opens May 1st.
Complete course preparing you for
license and best paying positions.
Rapid progress, individual atten-
tion, classes of limited size. Write
for descriptive literature.

Y. M. C. A. RADIO SCHOOL

Marcy Ave. near Broadway
Brooklyn, N. Y.

Telephone Williamsburg 3800

**New Foreign Radio
Apparatus**

(Continued from page 615)

shown in Fig. 5, which has microfonic con-
tracts, may be adapted for receiving sta-
tions of all types. It will respond to signals
which would otherwise be impossible to in-
tercept, it amplifies as well to a large ex-
tent signals which are within hearing. It
will function properly by the use of one
dry cell in the telephone circuit and may be
placed in any position, a fact which makes
it very useful on shipboard. Its operation is
controlled solely by the use of one set screw.
It may be said that its use has rendered
great service in many ways, particularly in
the French Navy during the recent
hostilities.

EDITOR'S NOTE—In the June issue we
will present a description of a few British
Radio instruments.

Club Gossip

(Continued from page 629)

The Electric City Radio Club Meets.

The regular weekly meeting of the Electric City
Radio Club was held in the apprentice school of
the Erie shops at Dunmore, Scranton, Pa., re-
cently. Roy Erhardt presided and a fine repre-
sentation of radio men was present. Lieutenant
Dawson, of the Scranton Electric Company, gave
an interesting talk on radio telegraphy and tel-
ephony on airplanes in the U. S. army of which
he had charge in France during the late war.

The subject of "Crystal Detectors" was the sub-
ject for discussion for the meeting and a number
of members told of their experience with them.
Prof. Neary, of Old Forge, presented a navy type
detector to the meeting.

The subject for the next regular meeting is
"Condensers and Receiving."

Persons in Scranton or vicinity interested in
"Radio" are eligible as members of the club. The
meetings are held in the apprentice school at Dun-
more shops every Tuesday evening, starting at
8:30 o'clock and visitors are welcome.

Several of the members of the club are ex-
service men and can give some excellent talks on
government equipment and service. Mr. Erhardt,
the chairman, had charge of the government sta-
tion at Cape May, N. J., during the war. The
majority of the members have installed receiving
sets and a number have sets for both sending and
receiving. The government restrictions which were
on for the period of the war have been removed
and this makes a fascinating recreation for persons
at all interested.

Mr. Blackburn, of the apprentice schools, or any
member of the club, will give any desired infor-
mation on this subject to interested parties.

Albany Radio Club.

All amateur radio operators in Albany are invited
to attend the code practise class which will be con-
ducted under the auspices of the Albany Radio Club
at the Central Y. M. C. A. The class has recently
been formed and all amateurs who have not reached
a speed of sending ten words a minute, which bars
them from obtaining a government license, will be
given proper instruction.

A number of booths have been erected and
installed with buzzers which those desiring in-
struction may use. The outlay is one of the most
complete in the city and members have been fitting
up a complete sending outfit which is expected to
be finished within a short time.

Geo. W. Bogar Radio Club.

Troop 26, of Harrisburg, Pa., is again setting the
pace by the installation of a complete modern radio
station for the use of the members of the troop.
They have organized the George W. Bogar Radio
Club, membership being restricted to Scouts of the
troop who have passed the second class, and which
will be in charge of a first class radio operator.

Courses of study in wireless telegraphy including
operation and construction of wireless stations will
be given to the members of the club, and the
apparatus, which is modern in every detail, will be
added to as the classes advance and will eventually
include a complete wireless telephone outfit.

The erection of the large aerial is going forward
rapidly and it is expected that the station will be
in operation within a very short time.

The George W. Bogar Radio Club will take a
prominent place in wireless circles.



**EASTERN
RADIO
INSTITUTE
RADIO**

899 Boylston St.
Boston, Mass.

Our prospectus for the asking

LEARN WIRELESS

TEL.
BACK BAY
5 9 6 4

Splendid opportunities now in
the Merchant Marine. Big sal-
aries. All graduates GUARAN-
TEED good positions by one of
the largest Wireless Telegraph
Companies operating hundreds of
ships to all parts of the world.
REMEMBER: We are the OLD-
EST, LARGEST and BEST
EQUIPPED school of its kind in
New England, and have THOU-
SANDS of satisfied graduates to
our credit. THIS SPEAKS FOR
ITSELF. Day and Evening
classes. Advanced classes in Ra-
dio Theory and code. Start any
Monday.

The Radio Club of America.

A meeting of the club was held on Friday evening, April 30, in room 402, Engineering Bldg., Columbia University, New York City.

A page entitled "Bulb Oscillators for Radio Transmission" was read by Professor Lewis A. Hazeltine, head of the Electrical Engineering Department of Stevens Institute of Technology, Hoboken, N. J. The paper dealt on the theory and design of oscillating circuits for radio transmission. Stress was laid on the difficulties experienced by the average experimenter. Professor Hazeltine also gave some new and special arrangements for power oscillators, among which was a three transmitter-bulb circuit having the property of oscillating in complete synchronism. This circuit which is a decidedly new one promises to become extremely valuable in future bulb transmission.

Major E. H. Armstrong predicted that in a few years the New York amateur will be in a position to readily converse with the San Francisco amateur with the same ease and facility that it is now being done by amateurs within the same state.

Some prominent radio folks were present, such as George H. Clark, Professor J. H. Morecroft, head of the Engineering Dept. at Columbia University Mr. Ryan of the General Electric Co. Mr. L. M. Clement, Mr. George Eltz, Mr. Walter S. Lemmon, Mr. L. S. Brown, Miss Marianne Brown, Mr. E. V. Amy, Mr. John Grinan, O. Roos, and last but not least Mr. Louis Gerard Pacent.

COMING EVENTS CAST A SHADOW BEFORE THEM.



The disappearance of a large bottle of "Castor Oil" remained quite a mystery until Ma gave Willie's Radio Set the O. O.

—DONALD BELL.

Ed. Note:—What do you think of the above cartoon? Can you think one up as good or better? At any rate try your hand at it. Send a radio joke in to R. A. N. with or without sketch. If good we will publish it; if bad we will feed it to our trained editorial goat.

The Radio Constructor

(Continued from page 623)

hole, bakelite or some other insulating material may be used. A thinner panel at the back must be fastened on the front panel on which to mount the springs. The springs in Fig. 4 (full size) can be made from some good spring brass or bronze strips and bent as in Fig. 4. Size to cut them Fig. 6. The wiring of coils is shown in Fig. 3. Aerial wire going on at B.P. and cord and plug connected to coupler. By plugging into various jacks the different wavelengths may be obtained.

Contributed by GEORGE MITCHELL.

SELLING BY RADIO.

A New York Radio concern has recently organized quite a unique manner of selling by wireless.

The company has been granted an operating license and has been allocated 2-ALF, which permits the firm to operate a complete transmitting and receiving set.

A full fledged and licensed operator is on duty from 9 A. M. to 10 A. M. and from 4 to 5 P. M. daily, standard time. Any amateurs desiring to communicate with them during these hours, will find ready response.

RADIO TELEPHONE AND TELEGRAPH APPARATUS OF MERIT

Send Four Cents for Our 50-page Catalogue

Immediate Delivery
May Specials
GOOD UNTIL MAY 20th, 1920

PERFECTION VACUUM VALVE PANEL

Complete assembled and connected vacuum valve panel with hardwood base. Panel of formica. Variable grid condenser, 10 point contact switch, panel rheostat, VT socket, 6 binding posts— Regular Price \$16.00
OUR PRICE—\$13.95

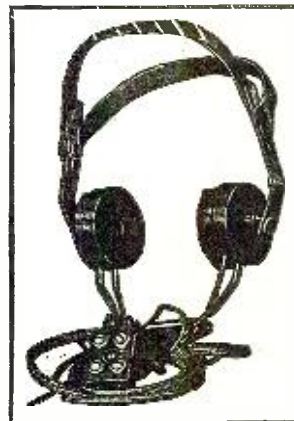

Perfection couplers, 20,000m., 2500 m. and 600 m. sizes. Regular price \$15, Now—\$8.95

- \$3.00 Graphite Potentiometers.....\$2.85
- 1.50 Detector and Crystal..... .95
- 5.85 Blitzen 43 Plate Variables..... 4.85
- No. 14 Copper Aerial Wire—per lb.... .50
- 50c Moulded Ball Insulators..... .35
- \$50 Navy Type Tuner and Condensers.35.00
- \$35 Coupler and Crystal Receiver.....24.00

Immediate deliveries on Brandes, Murdock, 55 and 30 Head Sets.

We Carry the Largest Stock of Wireless Goods in the Middle West

Distributors for

DeFOREST RADIO TEL. & TEL. COMPANY.

Amrad Products

William J. Murdock

Clapp-Eastham



WIRELESS AMATEUR

Send a 2c stamp for full description of the most efficient detector in the wireless field today.
Tested by Marconi Wireless Telegraph Co. and U. S. Government. Instantly adjustable at a constant pressure.

L. STEWART BARR, Inventor, Vice-President of The Service Radio School
THE BARR MERCURY-CUP DETECTOR Dept. B. The Wyoming, Washington, D. C.

A THOUSAND AND ONE FORMULAS

A Laboratory handbook for the Experimenter—by S. Gernsback (fully described on page 664). \$1.75. Experimenter Publishing Company, 233 Fulton Street, New York City.

Radio Diagrams and Formulae in Loose Leaf Form

The publishers of the CONSOLIDATED RADIO CALL BOOK have completed the preparation of diagrams and instructions on—

- Measurement of Capacity of a Condenser. (Substitution Method.) Calibration of a Variable Condenser. Two Diagrams and Curve...No. 1
- Measurement of Inductance of a Coil or Circuit. Two Methods—Two Diagrams.....No. 2
- Measurement of Distributed Capacity of an Inductance. Diagram and Curve.....No. 3
- Measurement of Fundamental Wavelength of an Antenna. Three Methods. Three Diagrams.....No. 4
- Measurement of Wavelength of Distant Transmitting Station. Two Methods. Calibration of a Receiving Set. Two Diagrams.....No. 5
- Measurement of Effective Antenna Capacity. Two Methods. Two Diagrams.....No. 6
- Measurement of Inductance of Antenna and a Third Method of Measuring Effective Capacity of Antenna. One Diagram.....No. 7
- Measurement of Antenna Resistance. Substitution Method.....No. 8
- Schematic Wiring Diagram of Regenerative Audion Receiving Set Suitable for Receiving High Power Undamped Wave Stations. Connections shown are those used in most Navy and Commercial Receivers.....No. 50
- Table giving the value of LC (Product of Inductance and Capacity) for wavelengths from 300 to 20,000 meters. Inductance in Microhenrys.....No. 100
- Table same as above but with Inductance in centimeters.....No. 101
- Schematic Wiring Diagram of Signal Corps Type SCR-68 Radio Telephone Transmitting and Receiving Set.....No. 51
- Schematic Wiring Diagram of Type CW-936 (Navy Submarine Chaser) Radio Telephone and Telegraph Transmitter and Receiver. No. 52
- Schematic Diagram of Type S.E. 1100 (Navy Flying Boat) Radio Telephone and Telegraph Transmitter.....No. 53

These diagrams and instructions are the most CLEAR, CONCISE, COMPREHENSIVE and CONVENIENT form of instruction that has ever been presented. They are printed on pages size 8 1/2 x 11.

Complete Set of 14 Sheets **75c** as described, sent postpaid

CONSOLIDATED RADIO CALL BOOK CO., Inc.
41 Park Row, New York, N. Y.

NEW VIBRATONE Jr. RADIO TRANSMITTING SET

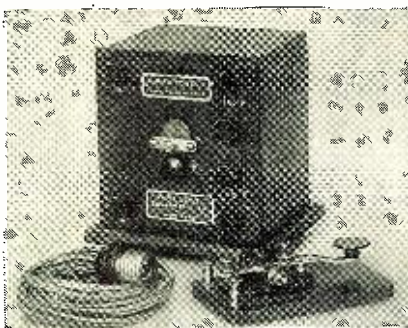

This Set Illustrated Above Operates on 110 VOLTS, D.C. or A.C. It is absolutely complete as shown. Needs no helix, spark gap, condensers, etc., etc. Simply connect to aerial, ground and electric circuit, and send.

NO BATTERY EXPENSE
Runs all day for 2 cents.
Sends three to five miles.

PRICE \$18.00 COMPLETE
With Key, Plug and 8-foot Cord

Send for descriptive circular 146D—To-day
WIRELESS EQUIPMENT CO., Inc.
19 Park Place New York, N. Y.

Dictionary of Radio Terms

(Continued from page 650)

Direct Loose Coupling—One in which the two inductance coils, thru metallicly connected, are at a distance from each other, or in which only a few turns are common to both circuits.

Direct Tight Coupling—Exists where one circuit has its inductance formed by tapping off a number of turns from the coil actually employed as inductance in the other circuit. Or when ratio between common turns is large. Also called Direct Close Coupling.

Disc Condenser—A variable condenser having its two sets of plates composed of semi-circular interleafing metal vanes, separated by insulating discs or air, the whole being mounted in a circular case. One set of vanes is fixed, whilst the other, mounted on an insulating spindle, is capable of being turned thru an angle of 180 degrees, thereby permitting of any desired amount of interleafing of vanes, and thus any required amount of capacity.

Discharge—To dissipate electric energy from a cell, condenser or any other charged body.

Discharger—That piece of apparatus in the primary oscillatory circuit in which the spark or arc takes place.

Disc Discharger—A disc having a number of metal studs on its periphery capable of adjustment, the whole being rapidly rotated between two electrodes, which may be either fixed or formed of rotating discs with or without studs.

Disruptive Discharge—Discharge in form of a spark. Due to sudden breaking down of resistance between dischargers.

Double-Fluid Cell—One in which the plates are each immersed in different liquids. See Bichromate, Bunsen, Daniell, and Grove.

Double Pole Switch—One which simultaneously makes or breaks both positive and negative wires of a circuit.

Downlead—Wire connecting elevated portion of aerial to the instruments. Portion passing into cabin is called Leading-in Wire.

Drum Armature—One having the windings round the core laid parallel to the shaft. See also Wave-wound and Lap-wound.

Dry Cell—Consists of a zinc retainer, having a lining of plaster of paris and flour, moistened with a saturated solution of Salammoniac, in the center of which is a carbon rod surrounded by manganese dioxide and crushed carbon. The whole is sealed up with pitch, with two small vent holes left for the gases to escape by. It is fitted with the necessary terminals and an outer cardboard sheath. Polarizes rather rapidly. Compare Leclanche Cell.

Dynamic Equator—An irregular curve encircling the earth drawn thru the point of each magnetic meridian where magnetic intensity is least.

Dynamo—Any machine capable of converting mechanical energy into electrical energy. Usually consists of rotating coils of wire (Armature) which cut lines of force produced by electromagnets (Field Magnets). A motor is a dynamo reversed, i. e., current is supplied to armature which causes it to rotate.

Dyne—C.G.S. Unit of Force. Is that force which when acting on a mass of one gramme for one second gives it a velocity of one centimeter per second. 3,835 Dynes equal one Poundal, the F.P. Unit.

Duplex Radiotelegraphy—A system of sending and receiving in which the two operations can go on simultaneously without interference.

W. SIEGERT WOOD PAT-TERNS

1250 West 97th Pl.
CHICAGO, ILL.

Special Radio and Electrical apparatus built to order

Electrical Experimental Work

Write for Estimates—I Will Save You Money

GET a good reasonable Grid or Stopping Condenser. Just the article you have been looking for. Each Condenser thoroughly tested by meter and guaranteed. All mounted with screws and nuts to assemble on panel. Price 35c each. Postage 4c.
Excellent mounted galena crystal, formerly purchased for U. S. Army Corps. Triple tested, each crystal guaranteed for satisfaction and efficiency. 75c each. Postpaid. Don't lose this opportunity to obtain these crystals. Only a limited supply.
Switch Mounting includes 1 Moulded composition Knob, polished nickel brush, etc., will fit any size panel. 50c.
Nickel Contact Studs, per doz..... 20c
Buzzers..... 75c
Push Buttons (for 5/8" hole)..... 25c
Stamps accepted. 5c Postage for above.
Send 2c for list of other apparatus. Dealers write for proposition on Condensers.



Esbro Radio Apparatus
P. O. Box 344, Brooklyn, N. Y.

NOTICE TO AMATEURS:



We carry in stock practically every known piece of radio apparatus on the market today that is worthy of consideration, and in most cases can make immediate shipment from our stock. Due to circumstances over which we have no control, our catalog will not be ready May 1st, as advertised in QST. We will begin mailing out catalogs about the 15th of May. Send in your orders and they will be executed promptly. Catalog requests will be filled as soon as off the press. Catalogs positively will not be sent, unless 15 cents in stamps is remitted.

Agent, Grebe Mfg. Co., Distributor for the South
NATIONAL RADIO SUPPLY COMPANY
808 9th Street, N. W. Dept. 140 Washington, D. C.

RADIO MEN WIRELESS AMATEURS

We carry a complete line of Grebe, De Forest, Marconi, Murdock, Clapp-Eastham, and all other leading makes of Radio Apparatus from Contact points to complete sets.

RADISCO APPARATUS

including Coils, "B" Batteries, Indicating Dials and other parts distributed by them. Mail Orders given prompt attention.

Open Evenings until 9.30 p. m.

KELLY & PHILLIPS
312 Flatbush Ave., Brooklyn, N. Y.
Telephone Sterling 2380.

AMATEURS

YOU REQUIRE SWITCH POINTS AND BINDING POSTS FOR THAT NEW SET.

SWITCH POINTS THAT ARE AC-CURATE.

1/4" Diameter and 1/4" High, Shanks for 6-32 Nuts—SIZES as below, Postpaid. This Month Only.

- 40 3/8" Shank, Nickel Plated....\$1.00
- 35 1/2" Shank, Nickel Plated.... 1.00
- 30 5/8" Shank, Nickel Plated.... 1.00

Dependable Radio Equipment and Parts See catalogue No. 9

DORON BROS. ELEC. CO.
Manufacturers, Hamilton, Ohio.

Earth—The term Earth is broadly used, and refers to any connection to earth, even when such connection takes place through the sea or a river.

Earth Connection or Earths—The connection to the upper portion of the earth's crust which is used in most systems of wireless telegraphy takes the form of a number of metal plates or wires embedded in the ground.

Earth Arrester—Small spark gap consisting of two brass discs separated by a disc of mica. Aerial is connected to top plate, and Earth to the lower. Receiving gear is shunted across gap, thus only receiving charges not strong enough to spark across and do damage to delicate detector, etc.

Earth Bolt Hexagonal—A six sided brass bolt with nuts at each end, used for attaching Earth Wire to hull of a ship.

Earthed Aerial—Any type of aerial using the Earth as Balancing Capacity.

Earth Plate—A metallic plate buried in the ground, to which are attached the earth connections.

Earth Wires—Wires leading to Earth Polts or other connections to Earth. Also refers sometimes to a network of wires buried in earth instead of earth plates.

Ebonite—See Vulcanite. S.I.C. about 3.2, but varies greatly.

Eddy Currents—Stray currents set up in core of electromagnets when magnetized by an alternating current, which dissipate themselves in the core, producing heat and causing loss. Is due to Electromagnetic Induction of induced pressures set up in the core. It is reduced by insulating the laminations of the core from each other with paper or varnish, etc., also called Foucault Currents.

Edison Cell—A type of accumulator having positive plates made of nickel hydroxide and flake nickel pressed in alternate layers into tubes formed of helical coils of strip nickel. Negative plates are of iron oxide and mercury held in perforated steel pockets. The separators are of rubber. The electrolyte is a solution of caustic potash. Furnishes about 1.2 Volts.

Efficiency—Generally expressed as a percentage, and is the number which denotes the ratio between the output of any apparatus for transforming energy and the intake of energy, both being reckoned in the same units.

Eindhoven Galvanometer—One used in conjunction with Photographic Recorder. Consists of an extremely thin thread of silvered glass stretched between poles of a strong magnet. The thread is in series with some suitable rectifying detector so that passage of oscillations set up a current in it (thread), which, owing to the magnetic field thus set up, is deflected. The slight deflection being magnified, and photographed on to a moving strip of sensitized paper.

Electric Absorption—The peculiar "soaking" up of a charge by a dielectric which delays a condenser in receiving its maximum charge producing "lag" in discharge, thereby forming Residual Charges.

Electric Field—Space surrounding an electrified body in which its influence can be noticed. Electric strain in a dielectric medium caused by an electrified body.

Electric Field—Space surrounding an electrified body in which its influence can be noticed. Electric strain in a dielectric medium caused by an electrified body.

Electric Induction—Electric strain in a dielectric medium. See Induction. Production of electrical effects at a distance.

Electricity—From Greek word "Elektron," meaning Amber. One of the earliest known methods of producing electric charges was by rubbing amber with silk. The word was first used by Dr. Gilbert of Colchester, England, in the year 1600.

Electric Ray—A stream of Electrons.



DUCK'S New Big 200-Page No. 14 Wireless Catalog and 100 Page Electrical Catalog

The wireless catalog mailed for 12c and the electrical catalog for 6c, either in stamps or coin, which amount you are privileged to deduct on your first order of \$1.00. Catalog positively not sent otherwise.

This edition of our wireless catalog is the most complete and elaborate we have ever put out. It embraces everything in wireless worth while. As an encyclopedia of information it is invaluable. It is printed on excellent paper and with a beautiful cover. Your amateur friend will tell you that there never has been any wireless catalog to take the place of Duck's, and above all that you can absolutely rely on the quality of every instrument listed in this catalog. In a word it is all worth while catalogs in one.

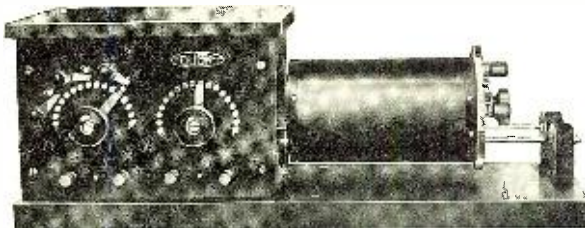

NEW MODEL 5BB. NAVY TYPE RECEIVING TRANSFORMER

A big improvement over our former model. Primary divided into four sections, with three dead end switches, greatly improving selectivity.

Secondary divided into three sections, with two dead end switches, eliminating harmonics. The change in the construction of the guide rod support makes it possible to obtain a looser coupling. It is a wonderful improvement over our old model both in performance and appearance. Only \$23.50.

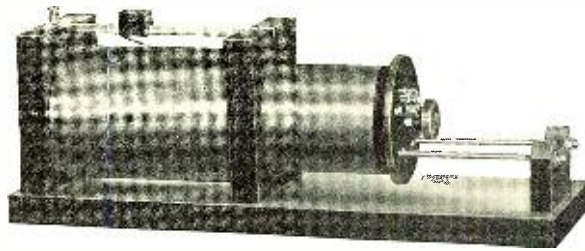

OUR IMPROVED ARLINGTON RECEIVING TRANSFORMER

The secondary on our new type Arlington is divided into three sections with two dead end switches, eliminating dead end effect and harmonics and giving greater selectivity. The end support is similar to that on our Navy type permitting a looser coupling. It is a beautifully finished instrument

Price Only \$12.50

THE WILLIAM B. DUCK CO., 231-233 Superior St., Toledo, Ohio



Our New Catalog "J"

READY FOR DISTRIBUTION APRIL FIRST

Contains 24 pages of instruments, raw materials and parts you can't afford to miss. A complete line of high grade, moderate priced apparatus including switch points, knobs, switches, meters, plain and threaded brass rod, copper strip, binding posts, screws, nuts, washers, etc.

Send 5c in stamps for your copy today

SHOTTON RADIO MANUFACTURING COMPANY

P. O. BOX 3, SCRANTON, PA.

UNIVERSAL SYSTEM RADIO APPARATUS

Efficient Equipment for all purposes Damped and Continuous Waves

Send stamp for catalogue

UNIVERSAL RADIO MANUFACTURING CORP., Dept. W., Elmira, N. Y.

45 VOLT \$4.35 Shipped by B-BATTERY Express only

Guaranteed Average Life of One Year Order One Today

THE H. S. WIRELESS CO. 164 Ross Street, Dept. F, Brooklyn, New York

NEW AND POPULAR BOOKS

The How and Why of Radio Apparatus

By H. W. SECOR, E. E.

This newest book on radio matters fulfills a distinct gap in wireless literature in that, while the treatment is made as understandable and as free from mathematics as possible, it at the same time, incorporates a wealth of technique and instruction for the Radio Amateur—the Radio Operator—the Installation and Designing Expert—as well as teachers and students of the subject in general.



A very broad field has been covered by the author, at the same time giving a great deal of information not found in other text-books. If you are engaged in any branch of the Radio or allied arts at all, you will surely need this latest contribution to radio literature, which is destined to be found on every radio man's book shelf before long.

A glance at the following list of chapters gives but a very scant idea of the extensive and useful radio knowledge provided in its text:

The Induction Coil; The Alternating Current Transformer; Radio Transmitting Condensers; The Spark-Gaps; Radio-Transmitting Inductances; Radio Receiving Tuners; Radio Receiving Condensers; Detectors; Telephone Receivers; Radio Amplifiers; Construction of a direct Reading Wavemeter and Detector; Antenna Construction; The Calculation and Measurement of Inductances; Appendix containing very useful tables, covering all subjects treated in this very unusual book.

This newest of Radio Works, cloth bound in Vellum de Luxe, Gold stamped and Hand Sewed has 160 pages. Size of Book 6 x 9 inches. The How and Why of Radio Apparatus, Postpaid.....\$1.75

A Thousand and One Formulas

By S. GERNSBACK

A Laboratory Hand Book for the Experimenter and for Everybody who wants to "do things."



A Book, brimful with very important and priceless information, collected and selected for years.

The recipes and formulas are classified in such a manner as to be available at once, without long research.

Invaluable for Students, Engineers, Physicians, Experimenters, etc.

Here are some of the chapter headings:

Cements and Glues; Compositions of All Kinds; Glass and Glassworking; Inks; Leather Polishes; Metal-craft; Perfumery, Soaps and Extracts; Photography; Blue Print and other Paper; Plating; Pyrotechny; Polishes and Stains; Varnishes and Paints; Various Cleaning Formulas; Wood-craft; Chemical Laboratory Hints and Experiments; Mechanical Laboratory Hints and Experiments; Electrical Laboratory Hints and Experiments.

Besides there are a score of tables and hundreds of illustrations and Diagrams.

Book is cloth bound in Vellum de Luxe.

Gold stamped and hand sewed.

It contains 160 Pages. The paper has been especially selected to stand rough handling in laboratories.

Size 6 x 9 inches.

A thousand and one Formulas, as described, Postpaid.....\$1.75

Design and Construction of Audion Amplifying Transformers

Radio and Audio-Frequency Type

This latest and important book by Mr. Edward T. Jones, late Associate Editor of *Radio News*, will be of great interest to all radio amateurs throughout the land. The transformers shown in these books have never been described in print before, and have usually been considered a manufacturer's secret. Anyone who has several vacuum tubes cannot afford to do without this book because it will enable him to build the necessary amplifying transformers very readily. The designs are very simple and rugged, and anybody can make them without trouble.



Mr. Jones, the author, is a practical man who is an experimenter himself and knows whereof he speaks. The book is printed on good paper and has an attractive cover in two colors. Paper bound. Size 5 in. x 7 in. Contains many illustrations, diagrams and working data necessary to build the transformers.

Price, Postpaid, 25c

Wireless Course in 20 Lessons

By S. Gernsback, A. Lescarboura and H. W. Secor, E.E.

A Course that tells you everything you want to know about "Wireless" starting off in lesson No. 1 by explaining the Principles of Electricity. By simple, easy stages, this wonderful Course takes you into "Wireless" by the use of such simple language so skillfully used that of necessity you must understand every word. There is a whole lesson devoted to the Theory and Mathematics of this epoch marking subject. The last lesson is devoted to a history of Wireless.

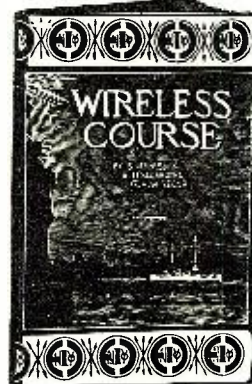

More than 50,000 of this course sold

(Eighth Edition)

Size of book is 7 x 10 1/4 in., 160 pages, 350 illustrations, 90 tables. Flexible cloth cover, per copy.....75c

Stiff cloth cover, per copy... \$1.25 Postpaid

Experimental Electricity Course in 20 Lessons

By S. Gernsback and H. W. Secor, E.E.



A Course on the theory and practice of Electricity for Experimenters. One of the most complete and comprehensive treatises of this special subject ever published. Written by the same authors as the famous "Wireless Course."

Every phase of experimental electricity is treated comprehensively in plain English. New Experiments are described and explained and nearly every application of Electricity in modern life is given in simple language.

The Best Electrical Text Book on the Market
Size of Book is 6 x 9 in.

The book contains 128 pages and more than 400 illustrations.
Flexible cloth cover, per copy.....75c
Stiff cloth cover, per copy.....\$1.25
Postpaid

Two Remarkable Books

Book No. 1—
How to make
Wireless
Sending Apparatus
Postpaid, 25c



Book No. 1 contains 100 pages, size 7 x 5 in., and 88 illustrations.
Book No. 2 contains 100 pages, size 7 x 5 in., and 90 illustrations.

Written and published entirely for the wireless enthusiast who wants to make his own radio apparatus. Only strictly modern instruments are described and the illustrations and descriptions are so clear and simple that no trouble will be experienced in making the instruments.

Book No. 2—
How to make
Wireless
Receiving Apparatus
Postpaid, 25c

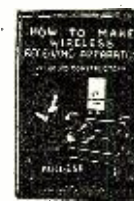

THE EXPERIMENTER PUBLISHING CO.

Book Dept., 233 Fulton Street

NEW YORK

Electro-Chemical Equivalent—The constant quantity of each element of an Electrolyte which is deposited by unit quantity of electricity. Weight in grammes deposited by one Coulomb. In this work the abbreviation is El. Chem. Eq.

Electrodes—Specially constructed terminals for passing an electric current thru any desired substance. See Electrolysis.

Electrodynamics—Science of electricity in motion. Current electricity. Electrokinetics.

Electrokinetics—See Electrodynamics.

Electrolysis—The decomposing of a compound into its component elements by passing an electric current through it. Electrodes, points at which the current enters (Anodes) and leaves (Cathode or Kathode) the compound to be decomposed (Electrolyte). Element given off at the Anode is the Anion; that given off at the Cathode is the Cation or Kation. In the case of water Oxygen is the Anion and Hydrogen is the Cation.

Electrolyte—See Electrolysis.

Electrolytic Detector—Consists of a fine platinum wire just touching an electrolyte contained in a small platinum cup. Electrolyte may be either 10% solution of Sulphuric Acid, dilute Alkaline Solution, or a 20% solution of Nitric Acid. Current from a local battery, which is connected to cup and point, keeps point covered with small bubbles owing to electrolysis. Passing oscillations break thru these bubbles destroying their insulating properties, and permit a momentary current from local battery to flow thru phones.

Electromagnet—A rod of iron, usually soft, rendered temporarily magnetic by a current passing thru insulated wire coiled round it. The current does not actually enter the iron, merely flows round it.

Electro-Magnetic Field—See Magnetic Field.

Electromagnetic Inertia—Reluctance to change. See Self-Induction.

Electrometer—Early form of Voltmeter.

Electromotive Force—See E.M.F.

Electron—Ultimate or final atom of negative electricity. An Atom plus an Electron is a negative Ion, an Atom minus an Electron is positive Ion. Electrons also called Negative Corpuscles.

Electron Relay—See Valve and Vacuum Tube.

Electrophorous—An induction instrument for producing small charges of static electricity. Consists of two discs, a thin brass one attached to an insulating handle, and an ebonite one lined on the lower side with tinfoil. The ebonite is rubbed with fur, giving it a positive charge; brass disc, held by insulating handle is now placed on ebonite, momentarily connected to earth and removed, when it is found to be carrying a positive charge.

Electro-Static Field—Range of space over which an electrified body has the power of inducing a charge, no matter how weak, into an unelectrified body.

Electroscope—An instrument for detecting static charges of electricity. Usually consists of two gold-foil leaves suspended on a brass rod held in a glass retainer, with a metal disc on other end. When a charge is brought near to the disc both leaves become similarly charged, therefore repel each other and diverge.

Electrostatic Induction—Induction arising from static charges.

Electrostatics—The science of electricity at rest.

Elektron—See Electron.

Element—A pure simple substance which is indivisible into other component substances by any known method. Compare Compound. There are about eighty known elements. Each element has a symbol, which is usually the first or first two letters of its Latin name, e. g., *Au* stands for Aurum which is Latin for



MIGNON "RW4" UNDAMPED WAVE RECEPTORS

NO Loose Couplers
Loading Coils
Variometers
Amplifiers

"RW4," Size 12" x 9" x 6 1/2"

Strongest, Most Distinct Signals

IMPORTANT—NOTICE

The Mignon System Apparatus, "RW1," "RW2," "RW3" and "RBD8" are no longer manufactured and are superseded by the improved "RW4," "UW1" and "BD1." These apparatus are manufactured exclusively by the MIGNON MFG. CORP., sole owners of the Mignon System Patents. (See U. S. Letters Patent No. 1329672.)

INFRINGERS WILL BE PROSECUTED
MIGNON MANUFACTURING CORPORATION, - - NEWARK, N. J.

DAMPED AND UNDAMPED WAVE APPARATUS FOR ALL PURPOSES

Endorsed by Radio Department of D., L. & W.
R. R. Co.

Write for Literature.

MIGNON MFG. CORP. NEWARK, N. J.

Dept. R
Canadian Representative—Canadian Radio Mfg. Co., Bienville, Que.

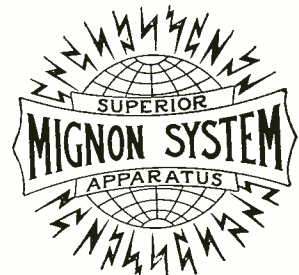

Latest Amplifier Developments

Are embraced in our "Saco" Two Stage and Detector and Two Stage Audio Frequency Amplifier. They embody the latest engineering practice in their design and construction.



Plug and Jack system employed in connecting the telephone receivers to the detector and respective stages of the amplifying circuits. Binding post are provided for regeneration, on the detector and two stage amplifier panel also for "A" and "B" battery connections.

The Saco Amplifier is absolutely guaranteed against Squealing, Howling or whistling.

"Saco" Type A-2. Two Stage Audio Frequency Amplifier, \$50.00.

"Saco" Type DA-1. Detector and Two-Stage Audio Frequency Amplifier, \$75.00.

Instructions and wiring diagrams accompany each Amplifier.

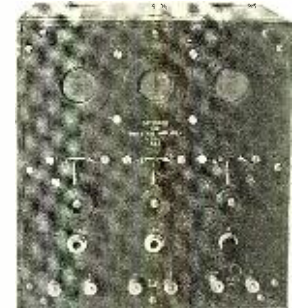

HUDSON RADIO CO.

182 Pulaski St., Brooklyn, N. Y.

Sole Distributors for S. Cohen Products in U. S. and Canada.

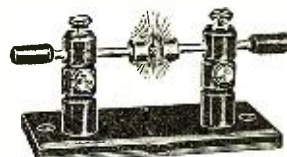

Spark Gaps,
75c, 90c, \$2.00.

American Electro Technical Appliance Company

235R Fulton Street New York City
FRESH STOCK "B" BATTERIES
25 Volt, 14 Amp., \$2.25

FULL STOCK OF DE FOREST,
GREBE, MURDOCK, AND OTHER
BEST MANUFACTURERS



The kind with
threaded
shank, with
nut, 3c ea.

AUDION CONTROL PANELS, \$6.00, \$10.50, \$12.00, \$19.00, \$22.00, \$24.00, without bulb. 2 STEP AMPLIFIER PANELS, \$50.00, \$69.00. JEWELRY TIME SET, \$27.00. DE FOREST HONEYCOMB COILS, price as per list. All mountings in stock. WESTERN ELECTRIC HEAD SETS, \$12.00. Brandes SUPERIOR HEAD SETS, \$7.00. DE FOREST DUST PROOF CRYSTAL DETECTOR, \$2.60. MARCONI TYPE, \$1.75. PARAGON RHEO-STAT, \$1.75. PARKIN RHEO-STAT, \$1.00. DE FOREST TYPE, \$1.00. Loose couplers, 800 meters, \$5.00; 4000 meters, \$10.00; Arnold type, \$19.00. Loads of other apparatus and parts on hand.

The Second Edition of the Consolidated Radio Call Book

Has Been Unavoidably Delayed

owing to the vast amount of work involved in bringing it right up to date and in compiling the big amateur section that will be a special feature. We urge all those who have placed their orders to be patient—you'll be glad you waited when you receive your copy, which will be very soon.

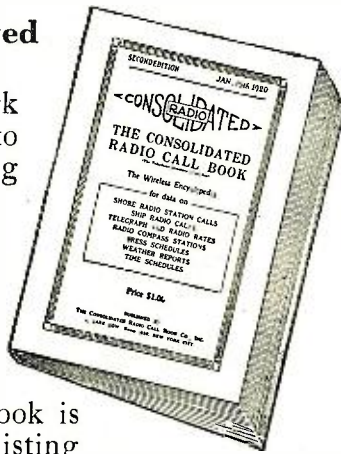

The Consolidated Radio Call Book is the only book in print officially listing all the radio calls as issued by the Bureau of Commerce. Every vessel and land station in the world is represented and listed alphabetically, according to names of vessels or land stations, and according to call letters; Revision of American coastal stations under U. S. Naval control, and their new calls.

All Amateur Calls Also Listed

SPECIAL Given Free with Each Copy

A Wireless Map of the World in colors is given absolutely free with each copy. This map shows the locations of all the high powered RADIO stations in the world, including the time signal stations. In addition it tells at a glance how far away any of these stations are. Of greater interest are the time zones, which enable the amateur to compute instantly the correct time for the zone in which he is located from any time signal station.

Price \$1.00 Prepaid

Either Direct from us or for sale by the following responsible Dealers:

American Electro Technical Appliance Co.
235 Fulton St., New York, N. Y.
Atlantic Radio Co.
34 Batterymarch St., Boston, Mass.
L. Bamberger & Co.
Newark, N. J.
Cutting & Washington Co.
6 West 48th St., New York City
L. W. Cleveland Co.
441 Congress St., Portland, Me.
J. H. Bunnell & Co.
32 Park Place, New York City
Doubleday Hill Electric Co.
719 Liberty Ave., Pittsburg, Pa.
Lester I. Jenkins
923 Purchase St., New Bedford, Mass.
A. T. Hovey
61 Belvidere St., Boston, Mass.
Klaus Radio Apparatus
Eureka, Peoria, Ill.
Manhattan Electrical Supply Co.
17 Park Place, New York City
114 S. Wells St., Chicago, Ill.
1106 Pine St., St. Louis, Mo.
604 Mission St., San Francisco, Cal.
McCarthy Bros. & Ford
75 W. Mohawk St., Buffalo, N. Y.

E. P. Noll & Co.
21 N. 5th St., Philadelphia, Pa.
Nola Radio Co.
134 Chartres St., New Orleans, La.
Newman-Stern Co.
1874 E. 6th St., Cleveland, Ohio
National Radio Supply Co.
1405 U St. N. W., Washington, D. C.
Pioneer Electric Co.
137 E. 5th St., St. Paul, Minn.
James W. Poole, Inc.
16 Columbia St., Boston, Mass.
F. D. Pitts Co.
12 Park Square, Boston, Mass.
Precision Equipment Co.
2437 Gilbert Ave., Cincinnati, Ohio
Radio Distributing Co.
4 West Park St., Newark, N. J.
Reuter Electric Co.
34 E. 8th St., Cincinnati, Ohio
Radio Equipment Co.
630 Washington St., Boston, Mass.
Southern Electrical Co.
3d and E Sts., San Diego, Cal.
H. E. Williamson Electric Co.
318 Union St., Seattle, Wash.
Jos. M. Zamolski Co.
Baltimore, Md.

Published by

Consolidated Radio Call Book Co., Inc.
41 Park Row, New York City

Gold. Most metallic elements in the Latin, end in *um*.

Emergency Apparatus—A small power set of transmitting gear carried on board ship, in addition to the main transmitter, which can be worked independently of the ship's supply of electricity. Consists usually of a battery of accumulators and a ten-inch induction coil. Later types have sufficient batteries to operate a complete high power set.

E.M.F.—Electromotive force. Unit is the Volt, which is that electric pressure necessary to force a current of one Ampere thru a conductor having a resistance of one Ohm.

Energy—Potential Power of work.

Energy Stored in a Condenser—Is directly proportional to capacity of condenser, and proportional to the square of the imposed voltage. Thus energy equals half of product of quantity times Volts, or half product capacity times Volts squared.

E.P.S.—Accumulator having pasted plates after the Faure principle, but built up on a special pattern of grid.

Equator of Magnet—Plane at right angles to axis and passing through Neutral line.

Equipotential Surface—A surface at every point of which the potential has the same value. Lines of force cut equipotential surfaces at right angles.

Erg—C.G.S. Unit of Work. Work done by one Dyne moving its point of application one centimeter. 421,390 Ergs equal one Foot-Poundal.

Ether—Name given to an imponderable medium presumed to permeate all matter and space. The standard, or ultimate, dielectric medium, to the action of which all electric and magnetic phenomena are to be referred.

Excite—To electrify or to magnetize, as for instance a dynamo's field magnet.

Exciter—Small auxiliary dynamo used to excite magnetic field of some types of generators.

External Circuit—The whole of a circuit, including the instruments, outside the generator.

This Dictionary will be continued in the June issue.

Radiophone Prize Contest Awards

(Continued from page 618)

vidually as well as when used two or three in parallel. We would expect a bank of six VT-1 to do some surprisingly long distant work in the hands of a high class operator.

We have tried out a half dozen or more other "hook-ups" and this is the most powerful and generally satisfactory of them all. The modulation of practically the full power of the radiated current is now giving us one ampere by the VT-2 tubes, and by VT-1 tubes .45 amperes. No trouble in duplicating results from day to day is found.

The Marconi VT-1 class 2 tubes are available now for amateur use, and the VT-2 are also available, for laboratory experimental work, and I believe the Radio Corporation of America, No. 233 Broadway, New York, a merger of the Marconi and General Electric Co., radio interests will soon be ready to supply power for radio work. If this proves correct, then one is not venturing far in predicting that within the next year or two there will be many tube sets found among the better amateurs, with these displacing in a whole or part their present spark sets. For it is seen that the cost of the entire outfit is under \$200; while if using apparatus that they have already on hand, the additional investment would be quite less.

A NEW MENACE.

The value of radio apparatus has gone up so high in recent years, that the sinister profession of second story men, gunmen, "yeggs," and others have left off stealing the family plate and jewels, and have gone into the game of carting away amateur radio stations.

A case of this kind occurred recently when Mr. Erald Schive of San Francisco, while entertaining friends at cards and relating his latest distance stunts, a gang of thieves broke into an adjoining room and carried away the entire apparatus valued at a considerable price.

Boys, watch your step. Don't lay yourself liable to this menace. Lock up your apparatus properly when you are not using it. One suggestion is that you wire your radio shack or room for a burglar alarm system, preferably the closed circuit type so that the presence of intruders will be known to you at any time. You may go one better by installing heavily charged wires around your station with a proper sign of warning.

THIS OUGHT TO HOLD YOU.

WANTED.—An efficient couple. Answer, Matrimony.

—E. J. HAMBLEN.

(Yes, but isn't an efficient coupler loose coupled?—Editor.)

STATEMENT

Of the ownership, management, circulation, etc., required by the Act of Congress of August 24, 1912, of RADIO AMATEUR NEWS, published monthly at New York, N. Y., for April 1, 1920.

State of New York, }
County of New York, } ss:

Before me, a Notary Public in and for the State and county aforesaid, personally appeared Hugo Gernsback, who having been duly sworn according to law, deposes and says that he is the editor of the RADIO AMATEUR NEWS, and that the following is, to the best of his knowledge and belief, a true statement of the ownership, management (and if a daily paper, the circulation), etc., of the aforesaid publication for the date shown in the above caption, required by the Act of August 24, 1912, embodied in section 443, Postal Laws and Regulations, printed on the reverse of this form, to wit:

1. That the names and addresses of the publisher, editor, managing editor, and business managers are:

Publisher, Experimenter Publishing Co., 233 Fulton St., New York City.

Editor, Hugo Gernsback, 233 Fulton St., New York City.

Managing Editor, Pierre H. Boucheron, 233 Fulton St., New York City.

Business Manager, R. W. De Mott, 233 Fulton St., New York City.

2. That the owners are: (Give names and addresses of individual owners, or, if a corporation, give its name and the names and addresses of stockholders owning or holding 1 per cent or more of the total amount of stock.)

Experimenter Publishing Co., 233 Fulton St., New York City.

Hugo Gernsback, 233 Fulton St., New York City.

Sidney Gernsback, 233 Fulton St., New York City.

H. W. Secor, 233 Fulton St., New York City.

3. That the known bondholders, mortgagees, and other security holders owning or holding 1 per cent or more of the total amount of bonds, mortgages, or other securities are (If there are none, so state):

None.

4. That the two paragraphs next above, giving the names of the owners, stockholders, and security holders, if any, contain not only the list of stockholders and security holders as they appear upon the books of the company but also, in cases where the stockholder or security holder appears upon the books of the company as trustee or in any other fiduciary relation, the name of the person or corporation for whom such trustee is acting, is given; also that the said two paragraphs contain statements embracing affiant's full knowledge and belief as to the circumstances and conditions under which stockholders and security holders who do not appear upon the books of the company as trustees, hold stock and securities in a capacity other than that of a bona fide owner; and this affiant has no reason to believe that any other person, association, or corporation has any interest direct or indirect in the said stock, bonds, or other securities than as so stated by him.

EXPERIMENTER PUB. CO., INC.,
H. GERNSBACK,
President.

Sworn to and subscribed before me this 1st day of April, 1920.

BEATRICE K. OWEN.

(My commission expires March 30th, 1921.)

AMPLIFY YOUR RADIO SIGNALS

With the new DETECTAGRAPH-TRANSMITTER, the amateur can amplify radio signals to such an intensity that he can hear the signals about his station without the need of the telephone head set.

By the addition of a loud talking telephone he is able to hear the messages many feet away from the instrument.

The super-sensitive DETECTAGRAPH-TRANSMITTER herewith shown is two and three-eighths inches in diameter, five-eighths of an inch thick and weighs less than three ounces. It is the most sensitive sound detecting device ever brought before the public.

The manner in which

the amplifying process is attained is by attaching with tape the DETECTAGRAPH-TRANSMITTER to the regular wireless receiver.

Not only is this instrument applicable for amplifying radio signals, but it can be used with equal satisfaction for magnifying other sounds. Phonograph music can be transmitted from one place to another by means of this instrument, and those who are afflicted with deafness will find enormous benefit by using this transmitter. It is the greatest device for building your own loud talking telephone, detectograph and other devices. Can be used for any purpose where a sensitive detecting instrument is required.



Our Super-Sensitive Detectograph Transmitter. Price, \$8.00 Complete



Our Special No. 25 Loud Talking Receiver. Price, \$4.50 Complete



Detectograph Rheostat, especially made for amplifying circuits. Price, \$2.00 Complete



Super-Sensitive No. 40 Receiver to be used in connection with Detectograph Transmitters. \$10.50



The Detectograph Junior Deaf-Phone \$18.00



Adjusted Model "B" Horn, with No. 20 High Grade Loud Talking Receiver, Cord Plugs and Desk Stand Base. Price, \$12.00 Complete



Adjusted Model "C" Horn, with No. 20 High Grade Loud Talking Wall Receiver, Cord Plugs and Wall Base. Price, \$12.00 Complete



Detectograph \$18.00 This detecting instrument of marvelous sensitivity can be used for detecting secret conversations. Output consists of Sensitive Transmitter, 25-ft. Black Cord, Receiver, Headband, Case and Battery.

Order direct from ad.

Or write for free descriptive circular.

G. BOISSONNAULT COMPANY
25 CHURCH STREET NEW YORK CITY
Makers of Super-Sensitive Microphone Devices



NEW MOTORS

FACTORY GUARANTEED - ALL SIZES - IN ORIGINAL BOXES

Your Opportunity

To Buy New Guaranteed Electrical Apparatus of Standard Manufacture.

Single Phase Motors

1/4	H. P., 110 volts, induction, full load start	\$28.50
1/2	H. P., 110-220 volts, induction, full load start	\$38.50
1/2	H. P., 110-220 volts, repulsion, for compressor	\$52.50
1	H. P., 110-220 volts, repulsion, with sliding base	\$76.50
2	H. P., 110-220 volts, repulsion, sliding base	\$116.50
3	H. P., 110-220 volts, repulsion, sliding base	\$142.50
5	H. P., 110-220 volts, repulsion, sliding base	\$184.50

Charging Generators

8 volts, 10 amp.	\$19.50
15 volts, 10 amp.	\$24.50
40 volts, 6 amp.	\$31.50
110 v., 2 1/2 amp.	\$31.50
110 volts, 3 amp.	\$46.50
40 volts, 30 amp.	\$78.50
110 volts, 18 amp.	\$106.50
110 volts, 25 amp.	\$146.50
Moving Picture Arc Generator 60 v., 35 a.	\$106.50

Polyphase Motors

2 and 3 phase, A. C., 220 v. 60 c., 1750 R.P.M., complete with base and pulley.	1/2 H. P. - \$46.50
	1 H. P. - \$64.00
	2 H. P. - \$81.00
	3 H. P. - \$96.00
	5 H. P. \$112.00
1 H. P., high speed, 3600 R.P.M., 220 v. 2 phase only	\$36.50

Battery Charging Outfits

To operate on A. C., 60 cycle, single phase. Voltage as specified.	
110-220 v., A.C., 150 watts, 15 v., with switchboard	\$68.50
110-220 v., A.C., 150 watts, 30 v., with switchboard	\$68.50
110-220 v., A.C., 175 watts, 24 volts, with switchboard	\$68.50
110-220 v., A.C., 250 watts, 26 volts, with switchboard	\$88.50
220 volts, 2 phase, 600 watts, 24 v., without switchboard	\$75.00

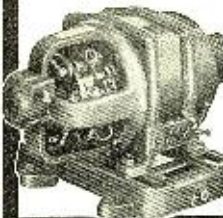

1/4 SPECIAL 110 volts A.C., 60 S. P., 1750 R.P.M. Complete, cord, plug and pulley. **WASHING MACHINE MOTORS** Suitable for operating Small Compressors, Coffee Grinders, Bottle Washers, Etc. **\$22.75** Each Reg. Val. \$32.50

SHIPPING TERMS: 25% deposit required on all orders. Balance C. O. D. by Express. Sight draft with Bill of Lading attached by freight.

MANUFACTURERS' DISTRIBUTOR
CHAS. H. JOHNSTON, Box 16, West End, Pittsburgh, Pa.

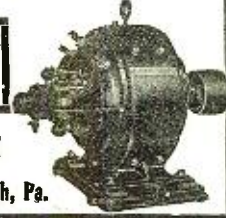

Arthur Batcheller

R. F. Trop

Guy R. Entwistle

MASSACHUSETTS RADIO and TELEGRAPH SCHOOL

Conceded by the Radio Fraternity to be the best equipped Radio School in New England. Write for literature.

18 BOYLSTON ST.

Tel. Beach 7168

BOSTON—11—MASS.

OPPORTUNITY AD-LETS

Follow these advertisements every month. Reliable advertisers from all over the country offer you their most attractive specials in these columns.

Classified advertising rate three cents a word for each insertion. Ten per cent discount for 6 issues, 20 per cent discount for 12 issues. No advertisement for less than 30c accepted. Name and address must be included at the above rate. Cash should accompany all classified advertisements unless placed by an accredited advertising agency.

Objectionable or misleading advertisements not accepted. Advertisements for the July issue must reach us not later than June 10.

THE CIRCULATION OF RADIO AMATEUR NEWS IS OVER 35,000

EXPERIMENTER PUBLISHING CO., INC., 236 Fulton Street, New York, N. Y.

Agents Wanted.

Traveling Men, Women—Best side line in the world; nothing to sell. Information only. J. H. Walker, Boulder, Colo.

Aeronautics.

100 Model Aeroplanes. Good flyers. 15c brings working Drawings and Prices. F. Bruland, Redford, Mich.

Propellers—for aeroplane propulsion; small propellers for motorcycle-driven snow and ice-sleds; road speedsters and hydroplanes. Can supply hub mountings, bearings, countershafting and sprockets complete. Pamphlets free. Crawford Motor and Aeroplane Mfr., 144 S. Rampart Street, New Orleans, La.

Compressed air motor for model airplanes, 3-cycle rotary, steel cylinders, aluminum crankcase. Model Machine Shop Co., 415 E. 71st Street, New York.

American Made Toys.

We offer an opportunity to manufacturers with facilities for large production, also to home-workers on smaller scale, to manufacture Metal Toys and Novelties. Unlimited field and enormous business open for ambitious people. No experience required. No tools needed. Our castings turn out goods complete. Since the different Toy Expositions, manufacturers are covered with orders until December. You can enter this field now by manufacturing "American Made Toys." We furnish castings for Toy Soldiers, Army, Navy, Marine, Cannons, Machine Guns, Indians, Cowboys, Warships and other novelties. Castings free, complete outfit, \$3.00 up. We buy these goods direct from manufacturers. Yearly contract orders placed with reliable parties. We pay very high prices for clean painted goods. Samples furnished. "Bird-Whistles," great seller, just added to our stock list. Booklet, Information, Instruction free, if you mean work and business. No others invited to write. Toy Soldier Manufacturing Co., 32 Union Square, New York.

Help Wanted.

Secret Service Operatives and Detectives in demand. Earn big money. Travel everywhere. Fascinating work. Learn this profession by home study. Particulars free. American School of Criminology, Dept. R, Detroit, Mich.

Be a Mirror Expert. \$3-\$10 a day; spare time home at first; no capital; we train, start you making and silvering mirrors, French method. Free prospectus. W. R. Derr, Pres., 579 Decatur Street, Brooklyn, N. Y.

Detectives make big money. Travel, be your own boss. Either sex. We instruct, small cost. Write Johnson's Detective School, 232 Sheldon Avenue, Grand Rapids, Michigan. Dept. A.

Dollars Saved. All kinds of used correspondence courses sold. (Courses bought.) Lee Mountain, Pisgah, Alabama.

Earn \$25 Weekly, spare time, writing for newspapers, magazines. Experience unnecessary; details free. Press Syndicate, 5665, St. Louis, Mo.

Railway Traffic Inspectors earn from \$110 to \$200 per month and expenses. Travel if desired. Unlimited advancement. No age limit. We train you. Positions furnished under guarantee. Write for Booklet CM 122. Standard Business Training Institute. Buffalo, N. Y.

Personal.

The Salesman Wins. Thousands of positions open. We teach traveling salesmanship by mail and guarantee offer of position or refund tuition. For interesting particulars, address Kansas Vocational Bureau, Miltonvale, Kan.

For Men.

Detectives Earn Big Money—Travel; great demand; experience unnecessary; we train you; write for free particulars. American Detective System, 1068 Broadway, N. Y.

Health.

Tobacco or Snuff Habit Cured or no pay; \$1 if cured. Remedy sent on trial. Superba Co., SB, Baltimore, Md.

Pyorrhea (Rigg's Disease—Bleeding or Swollen Gums)—Hundreds have been helped by "Pyorem," a successful home treatment. Purifying, healing, preventative. Full month's treatment, consisting of a very beneficial massage paste and an antiseptic tooth-cleansing paste to be used in place of your ordinary dentifrice together with full directions for treatment, \$1 postpaid. Or write for free Booklet "R." Pyorem Mfg. Co., 439 Seventh Street, Brooklyn, New York.

Patent Attorneys.

Millions spent annually for ideas! Hundreds now wanted! Patent yours and profit! Write today for free books—tell how to protect yourself, how to invent, ideas wanted, how we help you sell, etc. 301 Patent Dept., American Industries, Inc., Washington, D. C.

Patents promptly procured and trade-marks registered. Booklet, "Patents—How to Get Them," free on request. Write today. Clarence A. O'Brien, Patent Lawyer, Desk 1, Woodward Building, Washington, D. C.

For Inventors.

Inventors—Models, dies, tools. 28 years' experience, work guaranteed, lowest price. Manufacturing of specialties our hobby. Peerless Die & Tool Co., 121 Opera Place, D. B., Cincinnati, Ohio.

Experimenter Publishing Co.,
New York City.

Gentlemen:—

Have had splendid results in advertising in your "Radio Amateur News". Here's another ad to be inserted as soon as possible.

ROLAND M. PLACE,
350 Sprague St.,
Fall River, Mass.

Pictures.

The Capitol at Night—Most wonderful art panel you ever saw, 1x2 feet, 30 cents postpaid. Durso, Dept. 50, 25 Mulberry, New York City.

Printing.

3,000 two color labels \$1.25. Irvin J. Wolf, Station E, Philadelphia.

Photoplays Wanted.

Write Photoplays; \$50 to \$300 each. Free plan upon request. Los Angeles Photoplay Co., Los Angeles, Cal.

Rubber Stamps.

Rubber Stamps made to order. McCaddon Company, Zanesville, Ohio.

Song-Poems.

Song-Writers' Manual & Guide Sent Free. Contains valuable instructions and advice. Submit song poems for examination. We will furnish music, copyright and facilitate publication or sale. Knickerbocker Studios, 311 Gaiety Bldg., New York.

Stamps and Coins.

Coins, Medals, Paper Money, Antique Firearms, Indian Relics, Curios, Stamps. Catalogue free. Antique Shop, 33a South 18th, Philadelphia.

Wanted—Old Coins and Stamps. Highest prices paid. Send loc for our latest book on coins and stamps. James H. Querns, 1526 Haak Street, Reading, Pa.

1000 Nicely Mixed Stamps from all over the world, cat. up to 20c each, post free 59c. Dayton Postage Stamp Co., East Foxboro, Mass. We buy stamps.

Stamps, 100 different, 10c; 200, 25c; 50 U. S., 15c. Robert Mosher, 323 New Street, Newark, New Jersey.

100 Different Stamps, 12c; 200, 27c. Michaels, 5600 Prairie, Chicago.

1000 Mixed Postage Stamps only 25c. Antique Shop, 33 South 18th St., Philadelphia.

Free—Dollar stamp to approval applicants enclosing reference. Price list free. William Rometsch, Bridgeport, Conn.

Stamps 50c. Catalogue value, 15c. Particulars and Approvals. Stampcraft, Hanford, Cal.

205 Different Stamps, 25 cents. Veae, Box 1562, Detroit, Mich.

Stammering.

St-Stu-t-t-ering and Stammering cured at home. Instructive booklet free. Walter McDonnell, 121 Potomac Bank Bldg., Washington, D. C.

Scenery for Hire.

Collapsible Scenery for all plays. Amelia Grain, Philadelphia, Pa.

Telegraphy.

Telegraphy (both Morse and Wireless) and railway accounting taught thoroughly and quickly. Big salaries now paid. Great opportunities. Oldest and Largest School, Est. 45 years. Catalog free. Dodges Institute, 25th Street, Valparaiso, Ind.

Business Opportunities.

Big Money—in Pigeons, Poultry, Pheasants, Rabbits. Very pleasant to handle. Write today for free list. Pigeon Supply House, Hanover, Pa.

Special! A new magazine that especially wants now unknown Authors' and Inventors' work for publication! Copy, 10c. Year, \$1.00. Three Months, 25c. Idea Exchange, Brookings, So. Dak.

Turn Your Spare Time Into Money for that apparatus you want. Start a profitable, permanent home business. Steady weekly income. No investment but your brains and spare time. Positively no soliciting; agency proposition. Write today. Address, Opportunity, Box 175, Fredonia, N. Y.

Buy Direct from the Manufacturer. Mail Dealers and Agents. Directory tells where to buy over 1,000 articles. Price \$1.00 or stamp brings circular. Albert Porch, 7938 Bennett Avenue, Chicago.

Patents for Sale. To sell, buy or obtain patents write Patent News—309, Washington, D. C.

Start a chewing-gum factory in your town. Big profits. We have the best formulas and instructions; 10c. Write today. James H. Querns, 1526 Haak Street, Reading, Pa.

Substantial manufacturing corporation wants capable men to establish branch and manage salesmen. \$300 to \$1500 necessary. Will allow expenses to Baltimore as explained. Address, Treasurer, 416 N. Howard Street, Baltimore, Md.

\$30 Per 100 Paid for Names. Particulars free. Victor-King Co., 36 Bromfield, Boston (5) Mass.

Books.

Wanted—Back issues of Radio Amateur News and Electrical Experimenter. Boston Magazine Exchange, 109 Mountfort Street, Boston, Mass.

Star Amateur Electrician. Pocket size, 12c. Joel Tillberg, Proctor, Vermont.

Blunders of a Bashful Man—some side-splitting book, 30c. Chas. Durso, Dept. 50, 25 Mulberry Street, New York City.

Concordia Magazine contains essays, short stories, travel stories, boy scout news, editorials, current events and poetry, formulas and plans. Two years' subscription, 50 cents. Concordia Magazine, 9 Water, York, Pa.

Why Be Poor? Read "How to Get Rich," 60c. Joel Tillberg, Proctor, Vermont.

Married and Engaged people should read "Science of a New Life," nature explained. 400 pages, illustrated, \$2.00. Central Company, 601 Ninth Avenue, New York. Lists free.

Wireless Course in 20 Lessons. By S. Gernsback, A. Lescarbours and H. W. Secor, E. E. Tells you everything you want to know about "Wireless"—theory, practice and history. A clear, concise course on every phase of this subject. 160 pages—350 illustrations, 30 tables. Flexible cloth cover 75c postpaid. Stiff cloth cover \$1.25 postpaid. Experimenter Publishing Co., Book Dept., 233 Fulton Street, New York.

Experimental Electricity Course in 20 Lessons. By S. Gernsback and H. W. Secor, E. E. A course of the theory and practice of Electricity for the Experimenter. Every phase of experimental electricity is treated comprehensively in plain English. New experiments are described and explained and nearly every application of Electricity in modern life is given. 160 pages—400 illustrations. Flexible cloth cover, 75c postpaid. Stiff cloth cover, \$1.25 postpaid. Experimenter Publishing Co., Book Dept., 233 Fulton Street, New York.

Just Off the Press. Design and Construction of Audion Amplifying Transformers (Radio and Audio-Frequency Types). By Edward T. Jones, late Associate Editor Radio Amateur News. The transformers shown in this book have never been described in print before and have usually been considered a manufacturer's secret. The designs are very rugged and simple. A book that every radio "bug" should have. Written so you will understand every word. Price 25c postpaid. Experimenter Publishing Co., Book Dept., 231-A Fulton Street, New York City.

Office Devices.

Multigraphs, Addressographs, Duplicators, Sealers, Folders. Less than half price. Guaranteed one year. Pruitt Company, 112-C North La Salle, Chicago.

We Buy for Cash, Rebuild and Sell for about half new price, Multigraphs, Addressing Machines, Duplicators, etc. Don't be misled by firms infringing on our name. We are the original Office Device Company, 154-C West Randolph, Chicago.

Exchange.

One Minute Camera, great money-maker, \$15, or trade for good shotgun; describe fully. Durso, Dept. 50, 25 Mulberry, New York City.

For Sale—Knapp dynamo motor, \$5.00. Edward Suck, Warren, Michigan.

Let's Swap! What'd'ye got? What'd'ye want? Three months dime. National Exchange Medium, Detroit.

Wireless Apparatus for sale. Get circular. Jurek, 2642 Ballou Street, Chicago.

Do You Want a modern single-stage amplifying and receiving cabinet, mahogany case, bakelite panel, damp and undamp, complete with tubes, B batteries and phones, \$60, or trade for twin-cylinder motorcycle in A-1 condition, send for photos and description. Want Eaton Oscillator—manufactured by Wireless Specialty Co., or similar apparatus, also oscillation transformer. Will buy above or trade for radio apparatus. Have all kinds of transmitting and receiving apparatus to trade or will sell outright, including three-mile radiophone, at \$10. All inquiries answered. Edward Broun, East Marion, L. I.

For Sale—Partially finished receiving cabinet, consisting of Bakelite Panel, 12x12x1/4 inches, two 43-plate variable condensers, one 13-plate variable condenser, one Remler rheostat, one V. T. Socket. Condensers equipped with dial indicators. All instruments high grade. Will sell complete for \$20 prepaid. Myron Hatchkiss, Monrovia, Calif.

Sale or Exchange—Modern Electrics, 1914; Modern Mechanics, 1915; Popular Science, 1916; Service, 1906; Scientific American, 1913; American Boy, 1912; July-Dec., 1911; Gas Power, 1913-14. Also Benjamin Air Rifle, practically new, cost \$3.75; Correspondence Course on Violin, instrument included, cost \$24. Would like good set of Drafting Instruments. Donald L. Zook, Denver, Indiana.

12 G. A. Double Barrel Shotgun, L. C. Smith New. Cost \$45. For good receiving or sending set. Edgar Bowser, Pleasant St., Lonsdale, R. I.

For Sale—1/2-K.W. condenser, \$10; 20-inch Poly-phase Slide-rule, \$15. A. B. Brown, Bliss Electrical School, Washington, D. C.

For Sale—Three Western Radio Unit Loads—Brand New quartered oak case—Bakelite switch front 7 taps Pancake coils 1 15,000, \$12.00; 2 10,000, \$11.00 each. Postpaid. Will give good results as plate inductance for Armstrong Circuits. Martyn Cooney, 475 30th Street, San Francisco, Calif.

Bargain—Wireless, Electrical goods, etc. New and slightly used. Sell or trade. Send stamp for list. George B. Cummings, 228 E. Arch, Nevada, Mo.

For Sale—One set of new Hawkins Electrical Guides. Price \$9.00. Harold Tornquist, Caribou, Maine.

Standard Movie Machine, fifty dollars; fan, fifteen dollars; navy phones, ten dollars. Other bargains or will swap for up-to-date wireless set. Cohen, 248 East 121st Street, New York.

For Sale—1/6 K.W. transformer, \$7.00; Loose Coupler, 15x6x3/4, \$5.00; No. 7 American Model Builder with motor, almost new, \$15.00. Clapp Easton Receiving Transformer, \$7.50. William Davis, 231 Stanley Avenue, Canon City, Colo.

Exchange—Seven Type BB Edison primary batteries for Duck's audion panel set or other. With tube. Or sell—\$10. Exner, Salisbury Mills, N. Y.

Wanted—Brandes or Murdock receivers. Cheap. Herbert Frosell, 417 North Street, Peoria, Ill.

Wanted for Cash—De Forest, type T-100 multi-wave tuner; type P-300 audion—ultra-audion and one-step amplifier. Must be first class. Have fifty dollars worth of unused apparatus, send for list. Robert George, Concord, N. H.

Bargains! Loading coil, 5-inch tube, 16 inches high, \$1.75; Murdock \$510 loading inductance, \$2; Bowman detector, \$6.5; Murdock detector, \$8.5; fixed condenser, \$5.0; large antenna switch, \$1.50; three spark coils, \$1.00; steam engine, 11 inches high, \$7.5; 8 ball insulators, \$7.5; D.P.D.T. switch, \$5.0; D.P.S.T. fuse-switch, \$6.0; 4 knife-switches, \$4.0; switchboard, \$5.0; Postage Extra. Healey, 681 Harris, Providence, Rhode Island.

Bargain—1/2 K.W. transformer, \$9; Audiotron bulb, \$3; key, \$1; Murdock detector, \$1; step-down transformer, \$3. New. Wanted—V. T. Must be unused, 2 mid. condenser. Paul Barrett, 3150 Central Avenue, Indianapolis, Ind.

For Sale—Two brand new variables to mount on panel Tresco, .0005 mf., .001 mf. Cheap. Wanted—Electrical Experimenter for July and August, 1916. G. Edgar Stone, R. D. No. 1, Oswego, N. Y.

Sell—Set of Hawkins Electrical Guides, brand new, \$8. W. Robert Dresser, Calais, Maine.

Bargains—Buzzer Practice Set, \$1.75; 80-ohm receiver, \$9.0; Boy Mechanic, \$1.00; Watch Camera with finder, \$2.50; Rex Motor, \$8.5; Spark Coil, \$1.00. Thos. Heine, 4700 Garrison Blvd., Baltimore, Md.

Audion control panel, De Forest P-401, only four weeks old, worth \$13.25 new; first \$10 takes it. Harry Holcomb, 292 Clinton Road, Brookline, Mass.

For Sale—Complete sensitive receiving set. Call or write. Albert Hanak, 169 East 77th, New York.

Wanted—One and two K.W. United Wireless transformers. James P. Eschrich, 144 Grand Street, Jersey City, N. J.

Exchange—Cont'd.

For Sale—Omnigraph with 9 dials, \$6.75; Murdock 1500-meter loose coupler, \$6.75; copperplating outfit, complete, \$1.75; electrolytic interrupter, \$2.00; "G" bugle, \$4.00. All in excellent condition. Postage extra. Lorraine Jones III, 519 N. Taylor Avenue, Kirkwood, Mo.

\$35 Bunnell Rotary like new, \$20. Sell or exchange audion panel. Write Thomas King, Island Park, Dayton, Ohio.

Hams—Must sell my complete wireless station at once. Used two months. In first-class condition and guaranteed. Will sacrifice for quick sale. Write me for list and prices. William S. Knapp, Jr., 2634 Wabash Avenue, Kansas City, Missouri.

Punching Bag for good headset or De Forest variable. Sell Winchester 22 pump, \$9.00. James Keller, Alexandria, La.

Graflex Camera, 3/4x4 1/4 Bauch & Lomb high-speed anastigmat lens, film pack adapter, plate holders, value \$165.00. Want high-grade radio receiving outfit and two-stage amplifier. A. H. Lilley, 3826 N. 7th Street, Philadelphia, Pa.

For Sale—Dynamotor, runs on 110 volts D. C.; gives 112 volts, 60 cycles A. C., 2 K.W.; price, \$50.00. Frank Moore, 434 Hillary, New Orleans, La.

For Sale—\$45.00 Mignon RLC5 receiving cabinet, hear NAA, etc.; fine condition, \$30.00—\$18.00. Morse Omnigraph, with 15 dials, \$10.00. E. R. McFarland, St. James Hotel, Sapulpa, Okla.

For Sale—Complete sending outfit, Blitzen Interrupter, 2 one-inch coils, reliable key, stationary Gap, Condenser, \$7.00. Receiving Outfit: 2,000-meter coupler, loading coil, two detectors, 43-plate variable, fixed condenser and buzzer, \$9.00. Address J. Clinton Marschall, Hampton, Iowa.

Exchange—Back numbers Experimenter, 2 A Camera, Typewriter. Want V. Pocket Camera, R. Morgan, 211 Salisbury Street, W. Lafayette, Ind.

For Sale—36-inch electric boat, \$9.50; 1-inch spark coil, \$5.00; brass compass, \$5.00; 2-volt motor, \$5.5; wireless key, \$6.0; Edwards buzzers (\$5.5) each; 6-60 Witherbee storage battery, \$12.00; No. 3 Brownie, \$2.50; No. 3 Brownie enlarging camera, \$2.50; quart thermo bottle, \$2.00; Brandes Superior Phones, new, \$5.00; two printing frames, \$4.00 each; other odds and ends. Send stamp for details. Money orders only. Joseph Matis, 316 E. 80th Street, New York.

Will pay cash for No. 2 or No. 2, Jr., Omnigraph Continental Code. Also generator 24 to 40 volts, 3/4 to 1 kilowatt; good condition and cheap. Frank Pantel, Muscatine, Iowa, R. 1.

For Sale—20,000-meter coupler, \$7; 1/2 K.W. oscillation transformer, \$4. Orlo Palmer, 206 E. 13th, Holland, Mich.

For Sale—Sending and receiving set, mounted, 90-ft. aerial and switches. Also electrical goods. Write Eugene Rahn, Sidney, Ohio.

Wanted—Baldwin Phones. Spark Coils, two inches or larger, honeycombs. Variable or radio magazines, junk. Alex. Serna, Atoka, Oklahoma.

For Sale—Attention, Radio Experimenters, you can purchase my 20,000-meter loose-coupler, brand new, exact type of the famous Clapp Eastham Tuner. Brings in the long-wave arc stations fine. First \$25.00 takes it. Fully guaranteed. Easily worth \$45. Address Radio, 1010 "K" Street, S. E., Washington, D. C.

For Sale—Complete new De Forest unit set minus batteries and bulb. Mounted on panel, \$80.00. Special multi-wave receiver, detector and two-step amplifier, \$65.00. Prescott Smith, 542 Broadway, Paterson, New Jersey.

For Sale—12 new French B batteries, 25 each, worth 40 cents. New \$20 Violet-Ray Machine, \$13. Ray Schlegel, 1118 N. Negley Avenue, Pittsburgh, Pa.

For Sale—3-inch coil transmitting set, complete, \$16; Oliver typewriter, A1 condition, \$20; 6-volt 80-ampere-hour storage battery, brand new, cost \$40, sell \$20; write for list of other apparatus. J. A. Swank, R. F. D. No. 16, Dayton, Ohio.

Sell—Storage Battery, \$7.00. Geo. M. Teter, Sheridan, Indiana.

Sell—Audion Cabinet, \$5.50; Portable Set, \$10.00; Variable Condenser, \$1.25; Flashlight, 50c; Signal Corps Coupler, \$6.00; Coupler Coils, \$2.00. Particulars for stamps. R. Tanner, Park and Broadway, Walnut Beach, Conn.

Moving—Must sell my electrical laboratory equipment, etc., as follows: Three-panel black slate switchboard, 72x20 inches, pipe frame, switches, rheostat, \$50. X-ray tube, \$5.00. Electric locomotive, 40 feet track, etc., \$25. 1/4 H.P. D. C. motor, no base, never used, \$15. Powers No. 5 moving picture projector for home or professional use, mechanism perfect, complete with lenses, 15 reels good films, \$75. Edison 4-minute phonograph, perfect condition, 60 records, \$25. Partly finished 20-ft. biplane glider, carries 200 lbs., best Oregon spruce, complete except ribs and cloth, \$30. Standard Game pool table, almost new, balls, cues, etc., worth \$250, price, \$100. Lot small motor parts, spools fine silk wire, telegraph instrument, switches, insulators, small gears, pulleys, shafts, nuts, bolts, etc. Write P. T. Trueman, Box 514, Canton, Mass.

For Sale—One wireless receiving set. First money-order of \$18.00 takes it. Apply Charles Shedden, Woodstock, Ont.

Exchange—Cont'd.

Bargain—Receiving set. Consists of 4,500 meter coupler, Brandes tones, Burdick, fixt. and Detector, \$15.00. Also have other Electrical goods for sale. Harvey Munro, Flatonia, Texas.

For Sale—Audion cabinet, nine dollars. Half Kilowatt coil, five dollars. Murdock two thousand ohm phones, four dollars. Key, seventy-five cents. Motor, seventy-five cents. Aerial dollar, seventy-five cents. Switches, etc. H. Hatten, 1376 S. Maple St., Carthage, Mo.

For Sale—Navy type coupler, 2600 meters, \$12; cost \$20. Tuning Coil, \$1.50. Helix, \$1.50. Joseph Lapice, 1218 S. Harding Ave., Chicago, Illinois.

Sell Quick—K.W. Thordarson transformer, new, \$30.00. Condenser in oil for same, \$8.50. Rotary Gap, 5 speeds, runs to 8000 R.P.M., \$18.00. Key, heavy contacts, \$2.00. Must sell quick. Oscillation transformer, \$3.50. C. W. Reynolds, 25 Sturges St., Binghamton, N. Y.

One Pair Brandes "Superior" Phones, receiving cabinet, meters, motors, switches, spark-coil, 4-wire aerial, key, etc. Roger Whipple, 99 Central Street, Springfield, Mass.

Sell—Electrical and wireless goods. Send stamp for list. Elvis Watt, 733 Scott Street, South Bend, Indiana.

Will exchange wireless sending and receiving outfit for folding Kodak. John Schmelzeir, 90 St. Marks Place, New York.

Electrical Supplies and Appliances.

Bargain—50 110-v. generators—telephone type—like new, \$2 each. Cost \$6 new. Can be used for call systems, shocking machines, etc. Write for further particulars. Howard Lease, 618 Salem Avenue, York, Pa.

Water locating by Mansfield's water finder is interesting and profitable. Particulars from Edwin Mansfield & Co., 94 Victoria Road, New Brighton, England.

Experimental Electricity Course in 20 Lessons. By S. Gernsback and H. W. Secor, E. E. A course of the theory and practice of electricity for the experimenter. Every phase of experimental electricity is treated comprehensively in plain English. New Experiments are described and explained and nearly every application of electricity in modern life is given. 160 pages—400 illustrations. Flexible cloth cover, 75c. postpaid. Stiff cloth cover, \$1.25 postpaid. Experimenter Publishing Co., Book Dept., 233 Fulton Street, New York.

For Advertisers.

Money? Jacobus Art Ads make small space pay big dividends; price, \$5.00. Write today. Jacobus Service, 1073 Sanford Ave., Irvington, N. J.

Miscellaneous.

Have you anything for publication? Send it to me and have it neatly typewritten. Mechanical drawings made. Cheap rates. Write at once. Carleton Howler, 150 Russell Avenue, Akron, O.

Novelties.

Magic Water Flower, 10c; Fragrant Japanese incense, 15c and 25c package. Durso, Dept. 50, 25 Mulberry, N. Y. City.

News Correspondents.

Earn \$25 Weekly, spare time, writing for newspapers, magazines. Experience unnecessary; details free. Press Syndicate, 566 St. Louis, Mo.

Wanted to Buy.

You can raise cash by mailing us any old, broken jewelry, diamonds, platinum, broken watches, false teeth, bracelets, old gold, silver, silver plate, magneto points, platinum wire contact points, or crucibles, mercury, and all valuables. We pay the highest prices in spot cash by return mail, and will return your goods in ten days if you're not satisfied. The Ohio Smelting & Refining Company, 207 Lennox Bldg., Cleveland, Ohio.

Wireless.

For Sale—No. 26 Cotton Covered Wire, 75c per lb. Send spool. Also No. 28, No. 30 Green Silk Wire. Free samples. Ralph Winters, 404 Pearl Street, Camden, N. J.

Sale: Of slightly used apparatus at great reduction in prices. Complete transmitting and receiving set for sale in whole or part. Write for prices. They will interest you. B. W. Casselberry, Jr., Gibbsboro, N. J.

Fifty pairs Western Electric Airplane type Phones. Brand new. No headbands. \$17 a pair. George Klumph, 138 South Grove, Oak Park, Illinois.

Attention, Amateurs—Learn Code in one hour. Graphic chart and full instructions, 25c. Webb, Box 128, Station G, New York.

For Sale—One Audiotron Cabinet, without tube—Formica Panel, size 7 1/4" x 13". Beautiful Birch Mahogany Cabinet. Practically new. Price \$15. Robert Sagebiel, 25 West Second Street, Dayton, Ohio.

Spaghetti—small rubber tubing. Three-foot length postpaid for quarter dollar. Ideal for wiring that new panel. Stratton Electric Company, 215 Federal Street, Greenfield, Massachusetts.

(Continued on page 670)

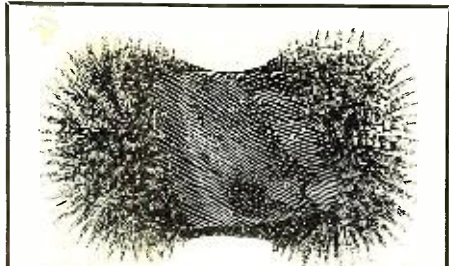

The Lucky Lode Stone

Have you a cabinet of minerals? Are you interested in scientific or wireless experiments? In aviation—in the magneto, and its magnets? Would you like to solve the unsolved problem of perpetual motion? Would you like to make a Viking compass out of a Lode stone? Do you think you can find an insulation for its magnetism? (so far unfound)

Get a Lodestone!
The writer has a few very powerful imported stones for sale—prices ranging from \$1 to \$5 according to size, shape, beauty and power. Write today.

Eugene S. Todd

113 FULTON STREET NEW YORK

Recognized as the largest and best.



Send ten cents for descriptive catalogue to Dept. B, 900-902 Penna. Ave., N. W. Washington, D. C.

TELEGRAPHY

Both wire and wireless, and Station Agency taught thoroughly and quickly, **BIG WAGES NOW PAID**, some of our recent graduates procuring \$138.00 per month to start. Great opportunities for advancement. Our school the oldest and largest—annual enrollment 600 students. Endorsed by railway, telegraph, wireless and government officials. Expenses low—chance to earn part. Catalog free. Write. **DODGE INSTITUTE, 26th St. Valparaiso, Ind.**

NEW ORLEANS
WIRELESS SUPPLIES AND
MINERALS OF ALL DESCRIPTIONS
L. A. ROSE
121 Camp Street
NEW ORLEANS, LA.
SEND 6 CENTS FOR CATALOG

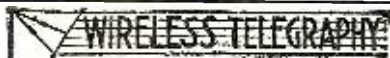

Make your own "Wireless" also Dynamos, Batteries, Motors, Telegraph, Telephone, Lights, Bells, Alarms, Coils, Current Reverser, Electric Engines, etc. Book with 75 Illustrations; by experts so anyone can understand it. With Catalog. All 10c, 3 for 25c pp

J. C. DORN
705 S. Dearborn St. Dept. 21, Chicago, Ill.

An HOUR a DAY

MAKE YOUR SPARE TIME PAY!

Take subscriptions for **RADIO AMATEUR NEWS**. It's easy—every wireless man wants **RADIO NEWS**—and we'll pay you well. Write now to
Subscription Department
RADIO AMATEUR NEWS
233 Fulton Street, N. Y.

HAVE YOU SOMETHING TO SELL OR EXCHANGE

Try an "Opportunity Adlet" in **RADIO AMATEUR NEWS**. Only 3c. a word for 35,000 circulation.

Navy Broadcasts For Amateurs

Code Translations for Month of April

[Ed. Note: Each month an abstract of the amateur code messages sent out by the New York Radio Station NAH will be published in RADIO AMATEUR NEWS. The purpose of this is so that amateurs who copy this code may have a means of checking up what they have received and thus know how they are progressing in receiving ability.]

The following messages were broadcasted in the Amateur Radio Code by Navy Radio Station, New York City, N. Y., on 1500-meter wave length, during April, 1920:

April 2nd. Code Two—Hereafter all Radio Compass work shall be done on a wave length of eight hundred meters.

April 5th. Code Eight—Effective April 5th, Navy Radio, New York, call letters NAH will transmit press news on fifteen hundred meters at three A. M. and nine P. M., seventy-fifth meridian time.

April 6th. Code Ten—Senate passed a bill fixing National Guard enlistments for three-year periods with subsequent enlistments for one year.

April 7th. Code Two—It may be of interest to know this amateur broadcast schedule is being copied by more than eight hundred amateurs and in forty different states.

April 8th. Code Two—Request letter report from all amateurs receiving this radio broadcast message addressed to Navy Radio Station, 44 Whitehall Street, New York City.

April 10th. Code Six—Naval Reservists who transfer to regular Navy are granted thirty days' leave with full pay.

April 11th. English—Four good radio operators can obtain desirable positions in the New York Naval Station by enlisting in the Navy for two years.

April 12th. Code Two—Acknowledge receipt of letter from operator Kennedy Beechwood, NJ; the Amateur Bureau is pleased to note their efforts are appreciated. Inquiry relative to commercial procedure has been referred to Chief Radio Inspector, Custom House, New York City.

April 13th. English—The American Library Association which is conducting the two-million-dollar quote books for everybody unquote movement wishes to know which are the ten best books of the sea. Amateur radio operators are requested to communicate with headquarters, 24 West Thirtieth Street, New York, in time to have voice in decision April 17th at National Marine Exposition.

April 14th. English—Acknowledge report of April 9th from Operator Murray, Peekskill, N. Y. Available undamp wave schedule will be broadcasted by NAH.

April 15th. Code Four—Acknowledge letter March 30th from Secretary Murray, Peekskill Radio Club. This broadcast will continue as scheduled.

April 16th. Code Two—Headquarters Boy Scouts of America advise quote a radio station in a Mohawk Indian village will be a strange sight at Eastern States Exposition, Springfield, Massachusetts, in September period. The village will be occupied by Boy Scouts selected from the Eastern States. Applications and exhibits received at Boy Scout Headquarters, 200 Fifth Avenue, New York, unquote.

April 17th. Code Ten—Acknowledge letters from operators Kelly, Brooklyn; McCall, Hoboken, and Operator Potter, Holyoke, Mass. This broadcast will be continued.

April 18th. Code Eight—Acknowledge letter of April 9th from Operator Litch, Montclair, N. J. Congratulations on progress reported. Will be necessary continue broadcast as scheduled.

April 19th. No broadcast sent.

April 20th. Code Two—Headquarters Boy Scouts of America advise quote radio apparatus made by Scouts will be among the competitive exhibits at the International Jamboree in London next August period two hundred Boy delegates and many exhibits will be sent by Boy Scouts of America entries close June one unquote.

April 21st. Code Six—Acknowledge report dated April 9th from Operator Reynolds, Rising Sun, Maryland. Radio licenses may be obtained from Radio Inspector, Customs House, Baltimore.

April 22nd. English—Two battleship divisions of the Atlantic Fleet will leave Annapolis June 5th for three months' cruise to many important ports in the South Atlantic and will also visit Honolulu and several ports on the west coast. Naval reservists desiring to make this cruise at full active duty pay should communicate immediately with the Commandant, Third Naval District.

April 23rd. Code Eight—Army Navy Baseball game of nineteen twenty will be played at Annapolis, May 29th.

April 24th. Code Ten—Marine Exposition at Grand Central Palace, New York City, April 12th to April 17th, included interesting exhibits from Navy Radio service.

April 25th. Code Two—Following from Radio Commodore American Seascouts quote to seascouts division and squadron pilots Boy Scouts of America, District Communication Service, Third Naval District, transmits our official, bulletins from its station NAH first message is "don't give up the ship." Acknowledge receipt by mail to Chief Seascout, two hundred Fifth avenue, New York. Stand by daily same hour unquote.

R. B. Coffman
Lieut-Commander, U. S. N.
District Communication Supt.

OPPORTUNITY AD-LETS

(Continued from page 669)

Wireless—Cont'd.

Bargain—Knocked down variable condensers for panel mounting, \$1.75 and up. Send 3 one cent stamps for prices. Simac, 1356 E. 72 place, Chicago, Ill.

Complete Equipment, Modern Radio Station; electrical apparatus, consisting of motors, generators, measuring instruments; engines, three gasoline marine, one steam. Send stamp for complete list. Leon G. Swenson, Oak Street, Shrewsbury, Mass.

"Silverplate" without electricity. Make your apparatus efficient, modern and commercial looking. One bottle of "Silverplate" plates your complete set. Just "rub" it on. 35c per bottle. Roberts Laboratory, 1178 Detroit Ave., Cleveland, Ohio.

Galena—Best grade, subject to bulk tests. 3 oz. 30c; postage, 4c. Radio Testing Station, 25 Sturges St., Binghamton, N. Y.

Knocked Down Variable Condensers for panel mounting. 41-plate \$2.75, 21-plate \$2.25, 11-plate \$1.75. Smooth running audion rheostats \$1.50. Add postage. Catalog 5c. R. E. Stowe, 623 Grand Ave., Dayton, Ohio.

Radio Amateurs—You would like to buy some radio apparatus or supplies—but you don't know where to get it at the most reasonable price. You don't? Then you just set down and write a few lines to the Radio Mail Order Supply Co., 533 West End Avenue, New York City, and state your wants fully. Our prices will surprise you. And remember—the larger your order the lower the cost. Now what do you need?

Switch Points. Sample 5c points are 1/4" by 1/4" with 1/2" shank. Per doz. 33c. Solid brass. Add 50% for Nickel Plating. Radio Testing Station, 25 Sturges St., Binghamton, N. Y.

Brass Rod. Round or square. Per foot 3/8", 15c. 1/4" 20c. Electrore Ball Insulators 35c. Add postage. Agency "Better Quality" B-Batteries. Philadelphia Radio Supply, 5714 Hazel Ave., Philadelphia.

For Sale—Receiving Set equipped with De Forest Triple Coil mounting and coils and Marconi V.T. 1-2 Variable Condensers, A and B battery, 2 megohm resistance, 3000 ohm headphone, all in 15 x 20 oak cabinet on bakelite panel. In A-1 condition. For a quick sale \$25.00 takes all. The Photo Shop, Madrid, Iowa.

Amateurs Attention—Loose Couplers from 800—15,000 meters, \$4—\$20. Tubes wound to specifications. N. A. Radio Equip. Co., 510 Claremont Parkway, Bronx, N. Y.

Audiotrons—\$5.00 postpaid. Genuine double filament of special thorium tungsten. Operating life of over 2000 hours. Its well known construction results in heavy plate current with corresponding signal strength. Plate voltage under 40. Satisfaction guaranteed, backed by the audiotron exclusive guaranty. Limited number at this prewar price. The Kehler Radio Laboratories, 901 West First St., Abilene, Kansas.

Free Radio Equipment. Send stamp. Philadelphia Radio Supply, 5714 Hazel Ave., Philadelphia.

Audion Control. Bakelite paneled with condenser, grid leak, audion-ultraudion switch, rheostat and cabinet holding 40-volt "B" batteries. Present batch \$10.00 each without batteries postpaid. You will be delighted. Edmund Gunning, 273 West 22nd, New York.

Genuine "Jupiter" stranded aerial wire 1 cent per foot, \$9.00 per thousand. Seven strands, No. 22 solid copper. High conductivity. Large surface. Strong. Low resistance. No C.O.D.'s. Send postage. Shipping weight 15 lbs. per 1000 feet. Lee A. Bates, 8 Moen St., Worcester, Mass.

Just off the Press. Design and Construction of Audion Amplifying Transformers (Radio and Audio-Frequency Types). By Edward T. Jones, late Associate Editor Radio Amateur News. The transformers shown in this book have never been described in print before and have usually been considered a manufacturer's secret. The designs are very rugged and simple. A book that every radio "bug" should have. Written so you will understand every word. Price 25c postpaid. Experimenter Publishing Co., Book Dept., 231-A Fulton Street, New York City.

Wireless Course in 20 Lessons. By S. Gernsback, A. Lescarboura and H. W. Secor, E. E. Tells you everything you want to know about "Wireless"—theory, practice and history. A clear, concise course on every phase of this subject. 160 pages—350 illustrations, 30 tables. Flexible cloth cover, 75c postpaid. Stiff cloth cover, \$1.25 postpaid. Experimenter Publishing Co., Book Dept., 236 Fulton St., New York.

How to Make Wireless Receiving Apparatus. 100 pages—90 illustrations. Only strictly modern radio apparatus are described in this book and the illustrations and descriptions are so clear and simple that no trouble will be experienced in making the instruments. Paper covered, 25c postpaid. Experimenter Publishing Co., Book Dept., 236 Fulton St., New York City.

How to Make Wireless Sending Apparatus. 100 pages, 88 illustrations. Written and published entirely for the wireless enthusiast who wants to make his own radio apparatus. Contains more information on "how to make it" than any other book we know of. Paper bound, 25c postpaid. Experimenter Publishing Co., Book Dept., 236 Fulton St., New York City.

SPECIAL TO YOU! Read this Remarkable Offer!

Here Are 3 Books You Should Have

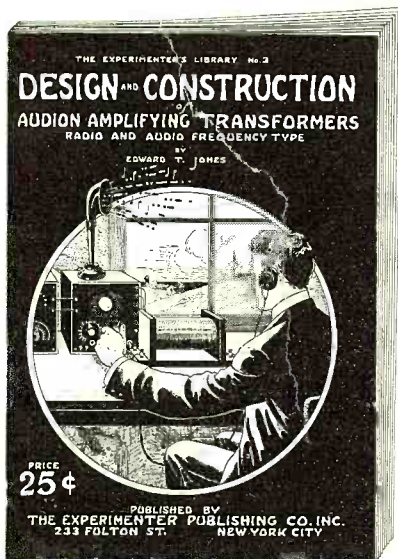

For a limited time we will send all three for only 50c when included with a one-year subscription to the RADIO AMATEUR NEWS. This offer is limited—it may be withdrawn at any time. Don't wait, get these books NOW and guarantee yourself twelve wonderful numbers of the RADIO AMATEUR NEWS.

Design and Construction of Audion Amplifying Transformers Radio and Audio Frequency Type

by E. T. Jones, late Associate Editor of RADIO AMATEUR NEWS, a wonderful book—the only one of its kind in print—

should be on the shelf within easy reach of every amateur. Every line of this book is written so that you can understand it. Every detail in the manufacture and construction of Audion Amplifying Transformers is described at great length. The book contains many illustrations and diagrams that make it a simple matter to build the Transformers described. Never before have these instruments been described in print. They have always been considered strictly a "trade secret."



How To Make Wireless Receiving Apparatus

A wonderful book for the man who would construct his own apparatus. Size 5 1/4 x 7 1/2 inches. Containing 100 pages and 90 illustrations. Compiled of the writings of twenty-five Radio experts. Every amateur should have this book in his wireless room.

Any wireless amateur can easily construct a complete sending and receiving station, and will have his choice of many varieties after reading these wonderful books.

How To Make Wireless Sending Apparatus

In every detail equal to "How To Make Wireless Receiving Apparatus." Size 5 1/4 x 7 1/2 inches. Containing 100 pages and 88 illustrations. Dealing at length on Quenched Spark Gaps, Rotary Gaps and Oscillation Transformers.

Remember, all three will be sent you postpaid just as soon as we receive your subscription and 50 cents toward the cost of the books.

EXPERIMENTER PUBLISHING CO., Inc.
236-A Fulton Street, New York City, N. Y.

R. A. N.
5-20

Experimenter Publishing Co.,
236-A Fulton St.,
New York, N. Y.

Gentlemen:—You may send me the three books described in the "Radio" Amateur News" and enter my name for a year's subscription to the "Radio Amateur News" for which I enclose \$2.50.

Name
Address
City State

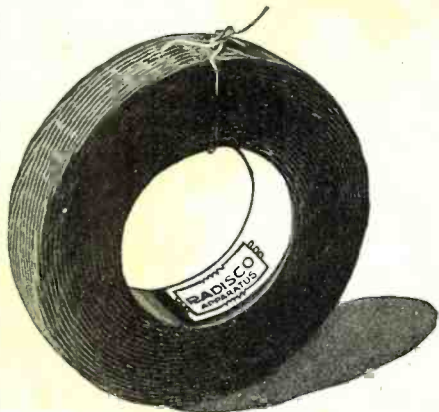

Two Famous RADISCO SPECIALTIES

RADISCO COILS

conceded by several well known Radio Men to be far superior to any similar type of Inductances. Made in seventeen sizes, tapped and plain. Wave length range from 200 to 20,000 meters, priced from 70c to \$4.85. Plentiful supply in stock at all Radisco Agencies.

RADISCO BETTER "B" BATTERY

is made according to Government specifications in two (2) sizes— $3\frac{1}{4} \times 2 \times 2\frac{1}{2}$ " and $6\frac{1}{2} \times 4 \times 3$ ". A first-class 15 cell, 5 group battery, VARIABLE VOLTAGE (Pat. applied for) is a special feature of this battery which enables you to provide critical voltage regulation for your vacuum tube by means of a switch connection with cells, taps of which have been taken off. Very economical and convenient. If one cell goes bad just test each group of 3 cells and short circuit the bad one. Price, small size, \$1.40. Large size, \$2.40, at any agency, or if ordered by mail include postage for 2 pounds on small size and 5 pounds on large size.

RADISCO AGENTS carry only apparatus of proven merit. Look for the Radisco trade mark on all parts you buy and be sure of getting efficient apparatus.

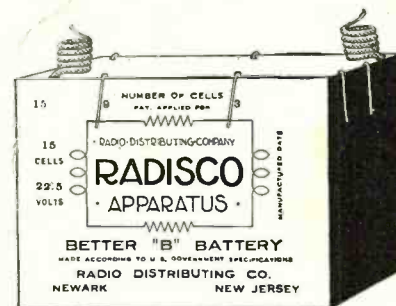

Below are listed a few of the reliable firms who carry the RADISCO COILS, Better "B" Batteries, and are our Agents for all other standard apparatus of merit.

COMMUNICATE YOUR WANTS TO THEM.

- | | | |
|---|--|---|
| ALBANY, N. Y.
E. L. Long,
21 Magnolia Terrace | EUREKA, PEORIA,
ILLINOIS
Klaus Radio Co. | PROVIDENCE, R. I.
Rhode Island Elec. Equip. Co.,
45 Washington Street. |
| ATLANTIC CITY, N. J.
Independent Radio Supply Co.
118 So. New Jersey Ave. | HAMPTON, N. H.
DeLancey Felch & Co., | PITTSBURG, PA.
Radio Electric Co.,
4521 Forbes St. |
| BALTIMORE, MD.
Radio Engineering Co.,
614 No. Calvert St. | LOS ANGELES, CALIF.
The Wireless Shop,
511 W. Washington St. | SCRANTON, PA.
Shotton Radio Mfg. Co.,
P. O. Box 3,
Branch 8 Kingsbury St.,
Jamestown, N. Y. |
| BEINVILLE, QUEBEC, CAN.
Canadian Radio Mfg. Co. | McKEESPORT, PA.
K. & L. Electric Co.,
427 Olive Street. | SPRINGFIELD, MASS.
Electric Service Co.,
585 Armory Street. |
| BOSTON, MASS.
Atlantic Radio Co.,
88 Broad St. | NEW ORLEANS, LA.
L. A. Rose,
121 Camp Street. | TORONTO, ONT., CAN.
The Vimy Supply Co.,
585 College Street. |
| BROOKLYN, N. Y.
Kelly & Phillips Electric Co.,
312 Flatbush Ave., | NEWARK, N. J.
A. H. Corwin & Co.,
4 West Park Street. | WASHINGTON, D. C.
National Radio Supply Co.,
1405 U Street, N. W. |
| BRONX, NEW YORK
Amateur Wireless Equipment
Co.,
1390 Prospect Ave. | NEWCASTLE, PA.
Pennsylvania Wireless Mfg. Co.
507 Florence Ave.
"8HA" | WICHITA, KAN.
The Cosradio Co.,
1725 Fairmount Ave. |
| CHICAGO, ILL.
Chicago Radio Laboratories,
1316 Carmen Ave. | PHILADELPHIA, PA.
Philadelphia School of Wire-
less Telegraphy,
Broad and Cherry Streets. | |

If none of the above agencies are in your vicinity, communicate with

RADIO DISTRIBUTING COMPANY : : Newark, New Jersey